

## AXA10W Series

10 Watts

DC/DC Converter

**Total Power:** 10 Watts  
**Input Voltage:** 9 to 36 Vdc  
18 to 75 Vdc  
**# of Outputs:** Single /Dual

### Special Features

- Package size 1.0" x 1.0" x 0.4"
- Ultra-wide 4:1 input range
- High efficiency up to 87%
- Operating temperature range: -40 °C to +80 °C
- Output voltage adjustable
- I/O isolation voltage 1500Vdc
- Remote ON/OFF control
- Input filter complies to EN55022, Class A& FCC, Level A
- Shielded metal case with isolated base plate
- 3 Years Product Warranty

### Safety

cUL/UL 60950-1  
IEC/EN 60950-1



## Product Descriptions

The AXA10W series are single and dual output DC/DC converter modules with industry standard pin configuration. All models feature ultra-wide 4:1 input range with excellent output voltage regulation. The AXA10W series can deliver up to 10W output power from the single or dual output module with high 87% typical efficiency and excellent thermal performance over an operating ambient temperature range of -40 °C ~ +80 °C.

Suitable for a wide range of applications in nearly any industry, the AXA10W was particularly designed with battery operated equipment, instrumentation and distributed power applications and other space critical applications in mind. The AXA10W series can be ordered with optional heatsink attached to optimize thermal management.

## Model Numbers

Model	Input Voltage	Output Voltage	Maximum Load	Efficiency
AXA02F18-L	9-36Vdc	3.3V	2.2A	86%
AXA02A18-L	9-36Vdc	5V	2A	84%
AXA00B18-L	9-36Vdc	12V	0.83A	86%
AXA00C18-L	9-36Vdc	15V	0.66A	87%
AXA000H18-L	9-36Vdc	24V	0.41A	86%
AXA00AA18-L	9-36Vdc	±5V	±1A	84%
AXA000BB18-L	9-36Vdc	±12V	±0.41 A	86%
AXA000CC18-L	9-36Vdc	±15 V	±0.33 A	87%
AXA02F36-L	18-75 Vdc	3.3V	2.2A	85%
AXA02A36-L	18-75 Vdc	5V	2A	84%
AXA00B36-L	18-75 Vdc	12V	0.83A	86%
AXA00C36-L	18-75 Vdc	15V	0.66A	87%
AXA000H36-L	18-75 Vdc	24V	0.41A	86%
AXA00AA36-L	18-75 Vdc	±5V	±1A	84%
AXA000BB36-L	18-75 Vdc	±12 V	±0.41 A	86%
AXA000CC36-L	18-75 Vdc	±15 V	±0.33 A	87%

## Options

Heatsink (-HS)

## Electrical Specifications

### Absolute Maximum Ratings

Stress in excess of those listed in the “Absolute Maximum Ratings” may cause permanent damage to the power supply. These are stress ratings only and functional operation of the unit is not implied at these or any other conditions above those given in the operational sections of this TRN. Exposure to any absolute maximum rated condition for extended periods may adversely affect the power supply’s reliability.

Table 1. Absolute Maximum Ratings:

Parameter	Model	Symbol	Min	Typ	Max	Unit
Input Voltage Operating -Continuous	24V input Models	$V_{IN,DC}$	9	-	36	Vdc
	48V input Models		18	-	75	Vdc
Maximum Output Power	All models	$P_{O,max}$	-	-	10	W
Isolation Voltage Input to output	All models		1500	-	-	Vdc
Isolation Resistance 500Vdc	All models		1000	-	-	Mohm
Isolation Capacitance 100KHz, 1V	All models		-	-	1500	pF
Operating Ambient Temperature	All models	$T_A$	-40	-	+80	°C
Operating Case Temperature	All models	$T_{CASE}$	-40	-	+100	°C
Storage Temperature	All models	$T_{STG}$	-50	-	+125	°C
Humidity (non-condensing) Operating Non-operating	All models		-	-	95	%
	All models		-	-	95	%

## Input Specifications

Table 2. Input Specifications:

Parameter		Condition	Symbol	Min	Nom	Max	Unit
Operating Input Voltage, DC	24V Input Models 48V Input Models	All	$V_{IN,DC}$	9 18	24 48	36 75	Vdc
Input Surge Voltage	24V Input Models 48V Input Models	1 sec, max	$V_{IN,surge}$	-0.7 -0.7	- -	50 100	Vdc
Start-up Threshold Voltage	24V Input Models 48V Input Models	All	$V_{IN,ON}$	- -	- -	9 18	Vdc
Under Voltage Shutdown	24V Input Models 48V Input Models	All	$V_{IN,OFF}$	- -	- -	8.5 17	Vdc
Input reflected ripple current	All Models	5 to 20MHz, 12uH source impedance	$I_{IN,ripple}$	-	30	-	mA
Input Current	AXA02F18-L AXA02A18-L AXA00B18-L AXA00C18-L AXA00H18-L AXA00AA18-L AXA000BB18-L AXA000CC18-L AXA02F36-L AXA02A36-L AXA00B36-L AXA00C36-L AXA000H36-L AXA00AA36-L AXA000BB36-L AXA000CC36-L	$V_{IN,DC}=V_{IN,nom}$	$I_{IN,full\ load}$	- - - - - - - - - - - - - - - -	352 496 483 474 477 496 477 474 180 248 241 237 238 248 238 237	- - - - - - - - - - - - - - - -	mA
No Load Input Current ( $V_O=On, I_O=0A$ )	AXA02F18-L AXA02A18-L AXA00B18-L AXA00C18-L AXA00H18-L AXA00AA18-L AXA000BB18-L AXA000CC18-L AXA02F36-L AXA02A36-L AXA00B36-L AXA00C36-L AXA000H36-L AXA00AA36-L AXA000BB36-L AXA000CC36-L	$V_{IN,DC}=V_{IN,nom}$	$I_{IN,no-load}$	- - - - - - - - - - - - - - - -	30 30 30 30 30 30 30 30 20 20 20 20 20 20 20 20	- - - - - - - - - - - - - - - -	mA

## Input Specifications

Table 2. Input Specifications con't:

Parameter		Condition	Symbol	Min	Nom	Max	Unit
Efficiency @Max. Load	AXA02F18-L	$V_{IN,DC}=V_{IN,nom}$ $I_O=I_{O,max}$ $T_A=25\text{ }^{\circ}\text{C}$	$\eta$	-	86	-	%
	AXA02A18-L			-	84	-	
	AXA00B18-L			-	86	-	
	AXA00C18-L			-	87	-	
	AXA00H18-L			-	86	-	
	AXA00AA18-L			-	84	-	
	AXA000BB18-L			-	86	-	
	AXA000CC18-L			-	87	-	
	AXA02F36-L			-	85	-	
	AXA02A36-L			-	84	-	
	AXA00B36-L			-	86	-	
	AXA00C36-L			-	87	-	
	AXA000H36-L			-	86	-	
	AXA00AA36-L			-	84	-	
	AXA000BB36-L			-	86	-	
AXA000CC36-L	-	87	-				
Remote On/OFF Control		Remote ON Remote OFF		2.5 0	- -	50 1	Vdc
Reverse Polarity Input Current		All		-	-	1.5	A
Short Circuit Input Power		All		-	2.5	-	W
Internal Power Dissipation		All		-	-	5	W
Internal Filter Type			Internal LC Filter (for EN55022,Class A/ and FCC level A compliance)				

## Output Specifications

Table 3. Output Specifications:

Parameter	Condition	Symbol	Min	Nom	Max	Unit
Output Voltage Set-Point	$V_{IN,DC} = V_{IN,nom}$ $I_O = I_{O,max}$ $T_A = 25\text{ }^\circ\text{C}$	$V_O$	3.234	3.3	3.366	Vdc
			4.90	5	5.10	
			11.76	12	12.24	
			14.70	15	15.30	
			23.52	24	24.48	
			$\pm 4.90$	$\pm 5$	$\pm 5.10$	
			$\pm 11.76$	$\pm 12$	$\pm 12.24$	
			$\pm 14.70$	$\pm 15$	$\pm 15.30$	
			3.234	3.3	3.234	
			4.90	5	4.90	
			11.76	12	11.76	
			14.70	15	14.70	
			23.52	24	23.52	
			$\pm 4.90$	$\pm 5$	$\pm 4.90$	
			$\pm 11.76$	$\pm 12$	$\pm 11.76$	
			$\pm 14.70$	$\pm 15$	$\pm 14.70$	
Output Current	Convection cooling	$I_O$	-	-	2.2	A
			-	-	2.0	
			-	-	0.83	
			-	-	0.66	
			-	-	0.41	
			-	-	$\pm 1.0$	
			-	-	$\pm 0.41$	
			-	-	$\pm 0.33$	
			-	-	2.2	
			-	-	2.0	
			-	-	0.83	
			-	-	0.66	
			-	-	0.41	
			-	-	$\pm 1.0$	
			-	-	$\pm 0.41$	
			-	-	$\pm 0.33$	

## Output Specifications

Table 3. Output Specifications con't:

Parameter		Condition	Symbol	Min	Nom	Max <sup>1</sup>	Unit
V <sub>O</sub> Load Capacitance	AXA02F18-L	All		-	-	560	uF
	AXA02A18-L			-	-	560	
	AXA00B18-L			-	-	150	
	AXA00C18-L			-	-	150	
	AXA00H18-L			-	-	68	
	AXA00AA18-L			-	-	220#	
	AXA000BB18-L			-	-	100#	
	AXA000CC18-L			-	-	100#	
	AXA02F36-L			-	-	560	
	AXA02A36-L			-	-	560	
	AXA00B36-L			-	-	150	
	AXA00C36-L			-	-	150	
	AXA000H36-L			-	-	68	
	AXA00AA36-L			-	-	220#	
	AXA000BB36-L			-	-	100#	
AXA000CC36-L	-	-	100#				
Output Ripple, pk-pk		20MHz bandwidth, measured with a 1uF MLCC and a 10uF Tantalum Capacitor	V <sub>O</sub>	-	60	100	mV
Line Regulation		V <sub>IN,DC</sub> = V <sub>IN,min</sub> to V <sub>IN,max</sub>	±%V <sub>O</sub>	-	0.3	1.0	%
Load Regulation		I <sub>O</sub> =15%I <sub>O,max</sub> to I <sub>O,max</sub>	±%V <sub>O</sub>	-	0.5	-	%
V <sub>O</sub> Dynamic Response		25% load change, slew rate = 1A/uS	±%V <sub>O</sub> t <sub>s</sub>	-	3	6	%
Peak Deviation				-	300	600	uSec
Settling Time							
Output Voltage Overshoot		All	%V <sub>O</sub>	-		5	%
Temperature Coefficient		All	%/°C	-	0.01	0.02	%
Switching Frequency		All	f <sub>sw</sub>	-	450	-	KHz
Output Over Current Protection		All		110	150	-	%I <sub>O,max</sub>
Output Short Circuit Protection		All		Hiccup Automatic Recovery			

Note1 - # for each output



## AXA02F18-L Performance Curves

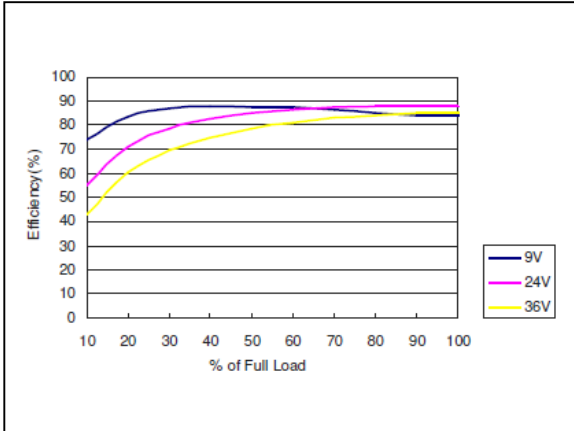

Figure 1: AXA02F18-L Efficiency Versus Output Current Curve  
 Vin = 9 to 36Vdc Load: Io = 0 to 2.2A

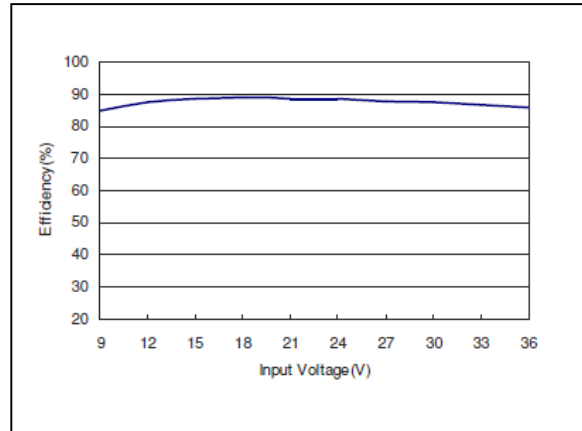

Figure 2: AXA02F18-L Efficiency Versus Input Voltage Curve  
 Vin = 9 to 36Vdc Load: Io = 2.2A

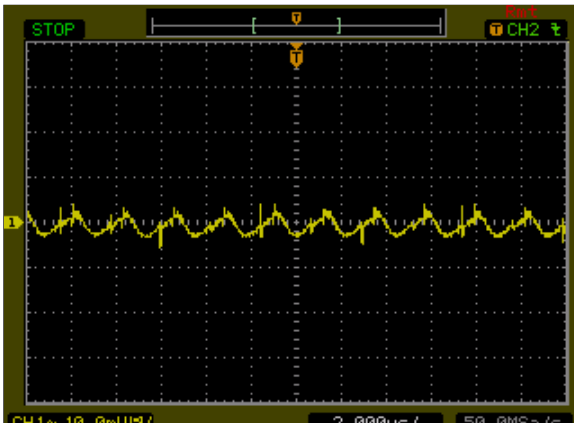

Figure 3: AXA02F18-L Ripple and Noise Measurement  
 Vin = 24Vdc Load: Io = 2.2A  
 Ch 1: Vo

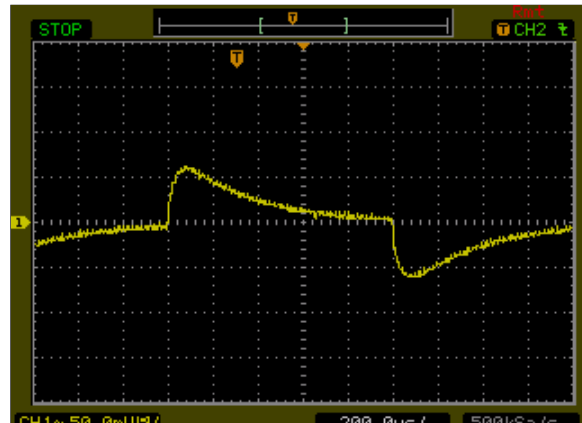

Figure 4: AXA02F18-L Transient Response  
 Vin = 24Vdc Load: Io = 100% to 75% load change  
 Ch 1: Vo

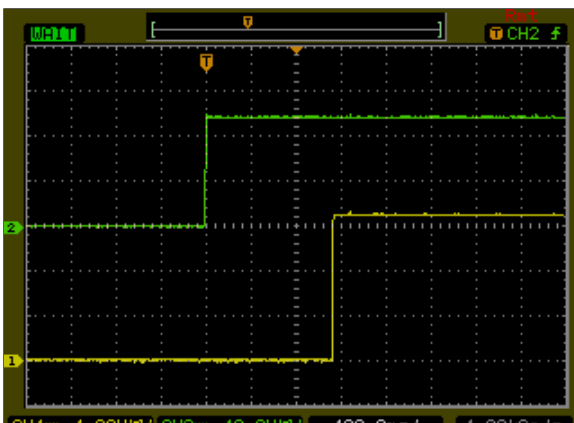

Figure 5: AXA02F18-L Output Voltage Startup Characteristic by ON/OFF  
 Vin = 24Vdc Load: Io = 2.2A  
 Ch1: Vo Ch2: Remote On/Off

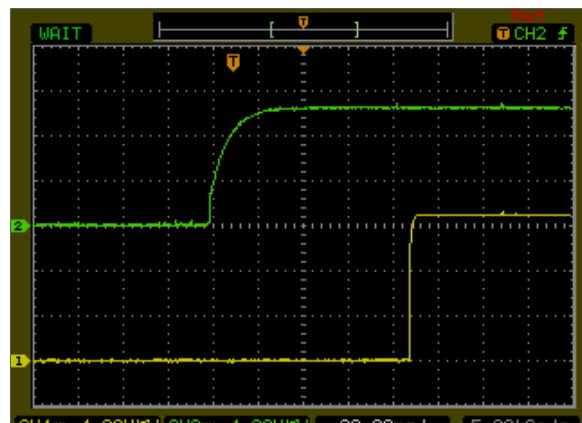

Figure 6: AXA02F18-L Output Voltage Startup Characteristic by Vin  
 Vin = 24Vdc Load: Io = 2.2A  
 Ch1: Vo Ch2: Vin



## AXA02F18-L Performance Curves

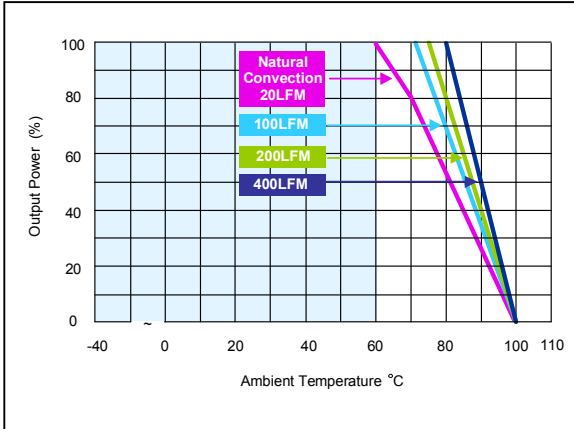

Figure 7: AXA02F18-L Derating Curves (without heatsink)  
 Vin = 24Vdc Load: Io = 0 to 2.2A

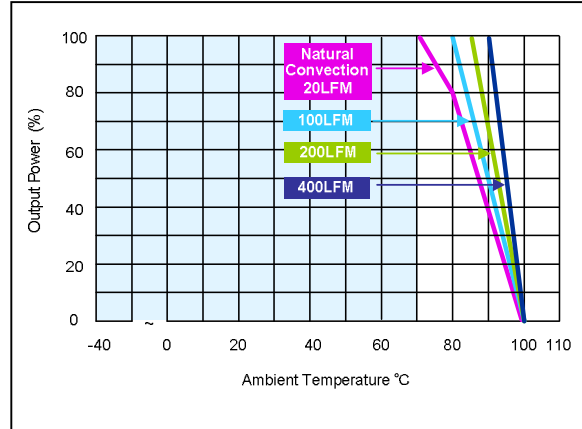

Figure 8: AXA02F18-L Derating Curves (with heatsink)  
 Vin = 24Vdc Load: Io = 0 to 2.2A

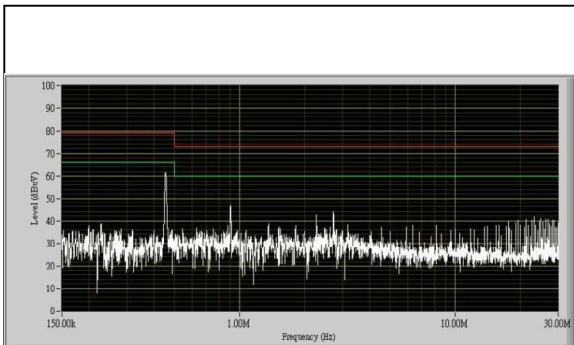

Figure 9: AXA02F18-L Conduction Emission of EN550122 Class A  
 Vin = 24Vdc Load: Io = 2.2A

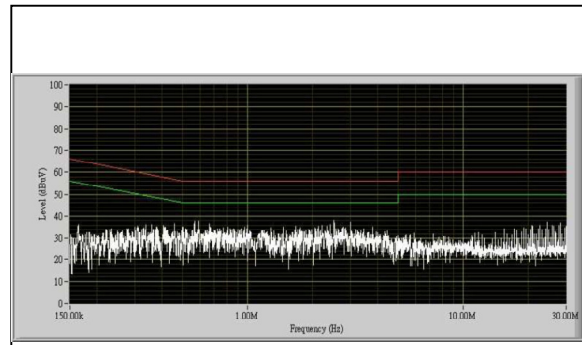

Figure 10: AXA02F18-L Conduction Emission of EN550122 Class B  
 Vin = 24Vdc Load: Io = 2.2A

Note - All test conditions are at 25 °C

## AXA02A18-L Performance Curves

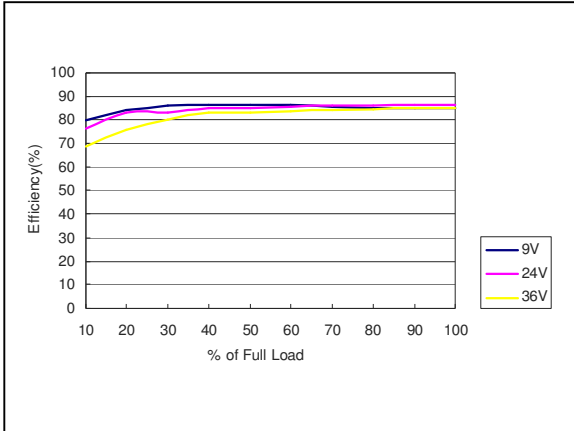

Figure 11: AXA02A18-L Efficiency Versus Output Current Curve  
 Vin = 9 to 36Vdc Load: Io = 0 to 2A

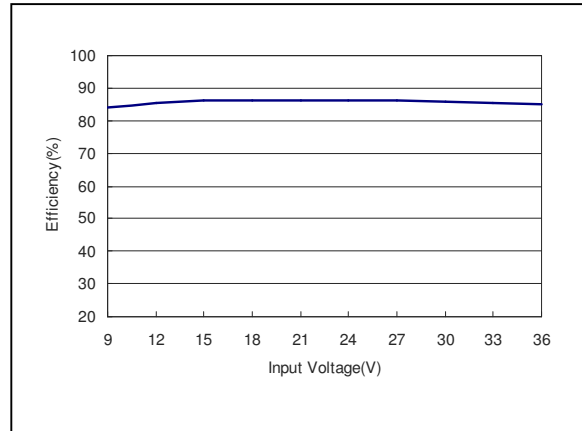

Figure 12: AXA02A18-L Efficiency Versus Input Voltage Curve  
 Vin = 9 to 36Vdc Load: Io = 2A

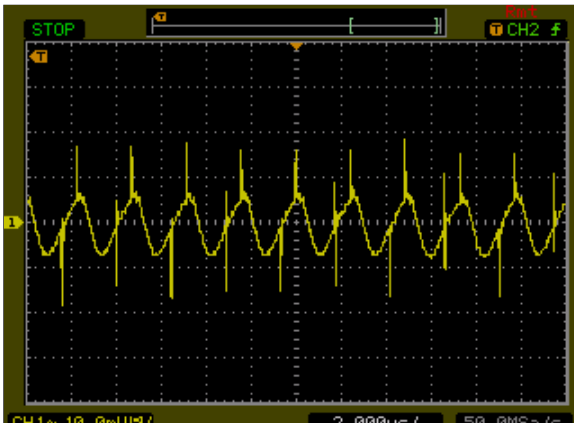

Figure 13: AXA02A18-L Ripple and Noise Measurement  
 Vin = 24Vdc Load: Io = 2A  
 Ch 1: Vo

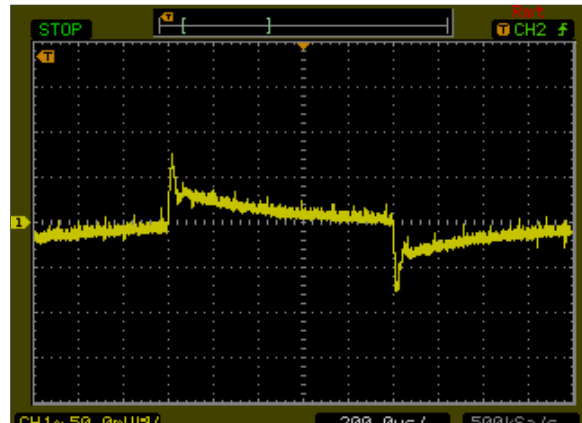

Figure 14: AXA02A18-L Transient Response  
 Vin = 24Vdc Load: Io = 100% to 75% load change  
 Ch 1: Vo

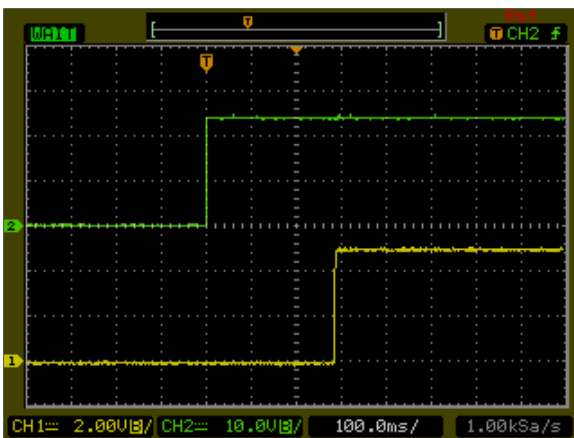

Figure 15: AXA02A18-L Output Voltage Startup Characteristic by ON/OFF  
 Vin = 24Vdc Load: Io = 2A  
 Ch1: Vo Ch2: Remote On/Off

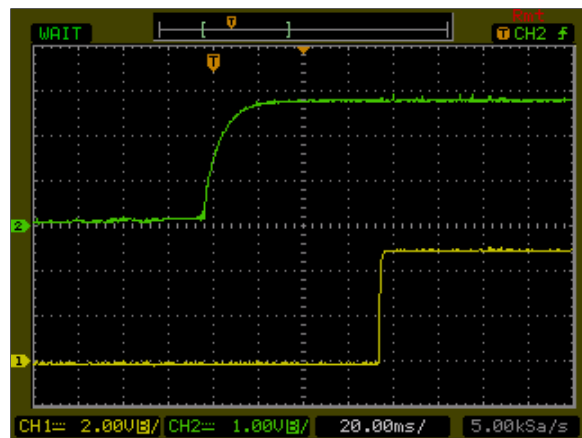

Figure 16: AXA02A18-L Output Voltage Startup Characteristic by Vin  
 Vin = 24Vdc Load: Io = 2A  
 Ch1: Vo Ch2: Vin

## AXA02A18-L Performance Curves

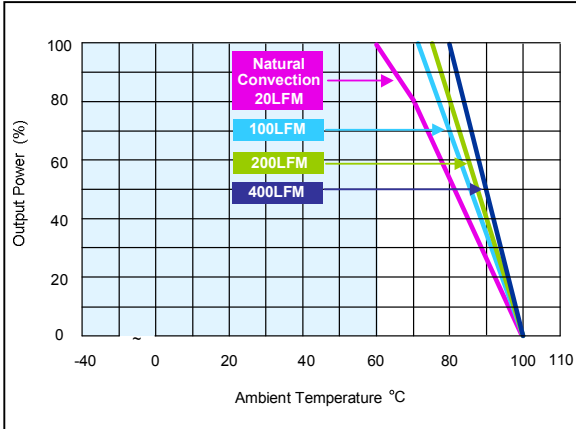

Figure 17: AXA02A18-L Derating Curves (without heatsink)  
 Vin = 24Vdc Load: Io = 0 to 2A

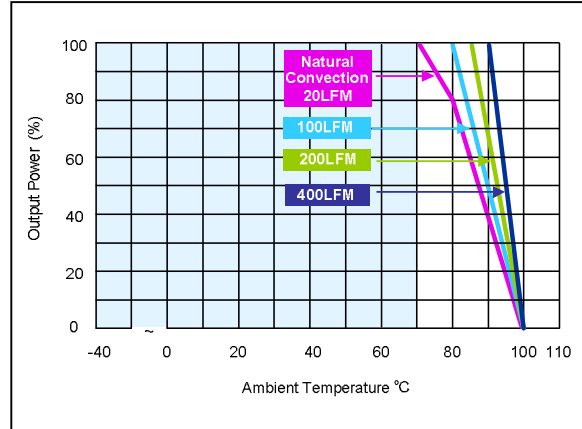

Figure 18: AXA02A18-L Derating Curves (with heatsink)  
 Vin = 24Vdc Load: Io = 0 to 2A

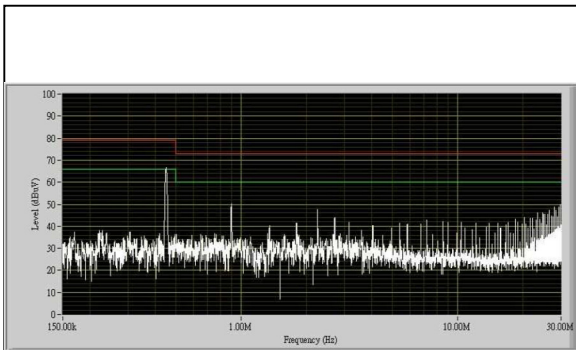

Figure 19: AXA02A18-L Conduction Emission of EN550122 Class A  
 Vin = 24Vdc Load: Io = 2A

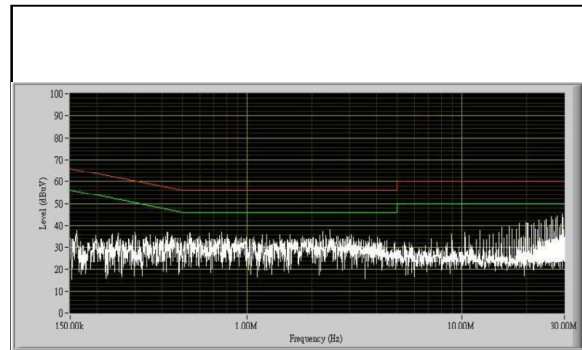

Figure 20: AXA02A18-L Conduction Emission of EN550122 Class B  
 Vin = 24Vdc Load: Io = 2A

Note - All test conditions are at 25 °C

## AXA00B18-L Performance Curves

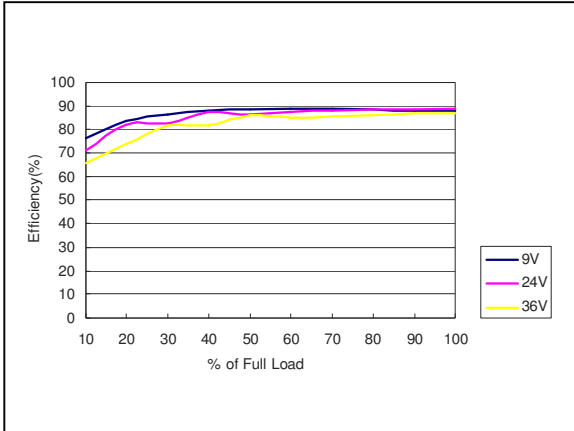

Figure 21: AXA00B18-L Efficiency Versus Output Current Curve  
 Vin = 9 to 36Vdc Load: Io = 0 to 0.83A

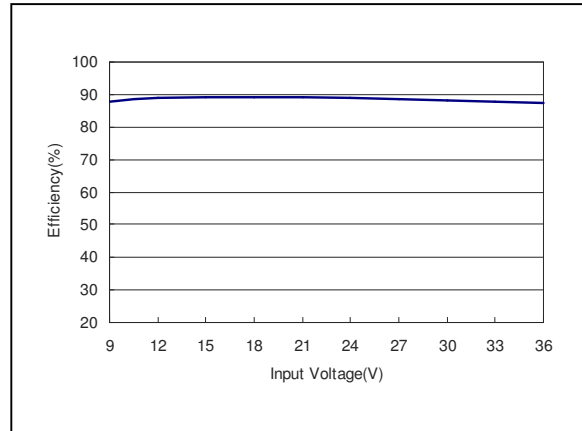

Figure 22: AXA00B18-L Efficiency Versus Input Voltage Curve  
 Vin = 9 to 36Vdc Load: Io = 0.83A

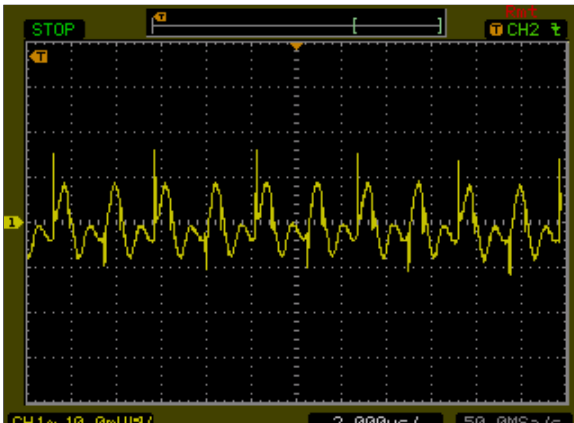

Figure 23: AXA00B18-L Ripple and Noise Measurement  
 Vin = 24Vdc Load: Io = 0.83A  
 Ch 1: Vo

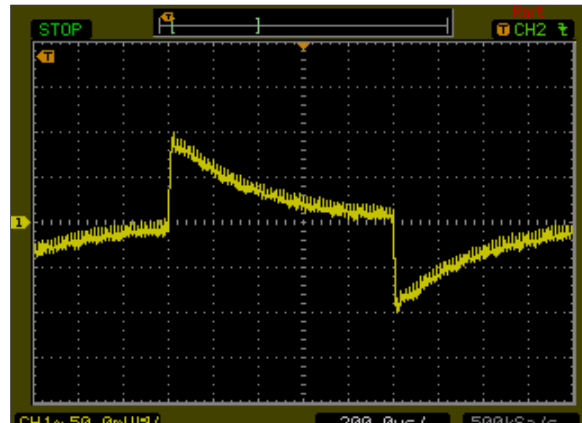

Figure 24: AXA00B18-L Transient Response  
 Vin = 24Vdc Load: Io = 100% to 75% load change  
 Ch 1: Vo

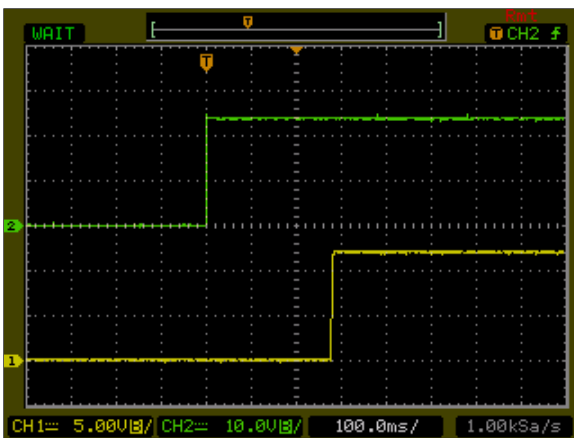

Figure 25: AXA00B18-L Output Voltage Startup Characteristic by ON/OFF  
 Vin = 24Vdc Load: Io = 0.83A  
 Ch1: Vo Ch2: Remote On/Off

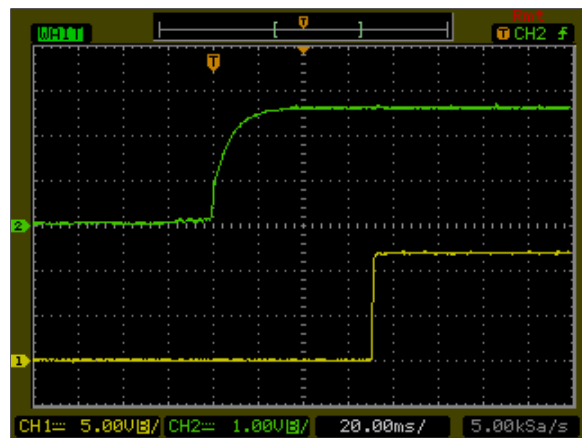

Figure 26: AXA00B18-L Output Voltage Startup Characteristic by Vin  
 Vin = 24Vdc Load: Io = 0.83A  
 Ch1: Vo Ch2: Vin

## AXA00B18-L Performance Curves

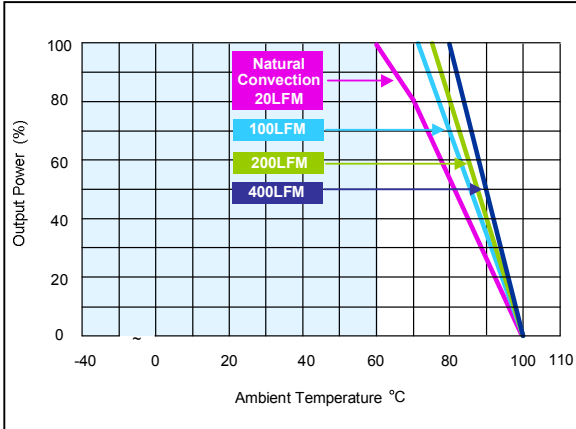

Figure 27: AXA00B18-L Derating Curves (without heatsink)  
 Vin = 24Vdc Load: Io = 0 to 0.83A

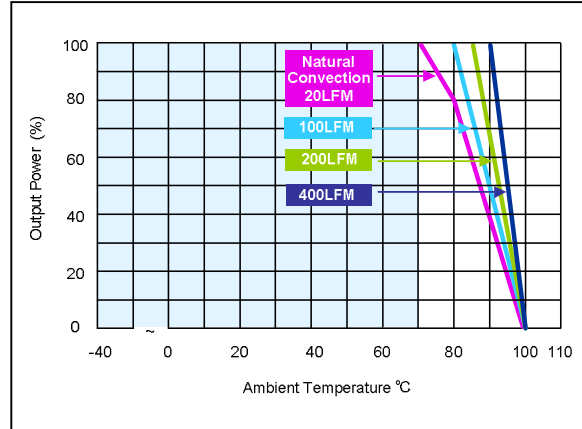

Figure 28: AXA00B18-L Derating Curves (with heatsink)  
 Vin = 24Vdc Load: Io = 0 to 0.83A

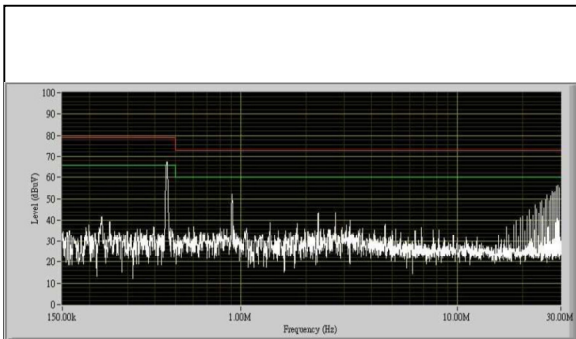

Figure 29: AXA00B18-L Conduction Emission of EN550122 Class A  
 Vin = 24Vdc Load: Io = 0.83A

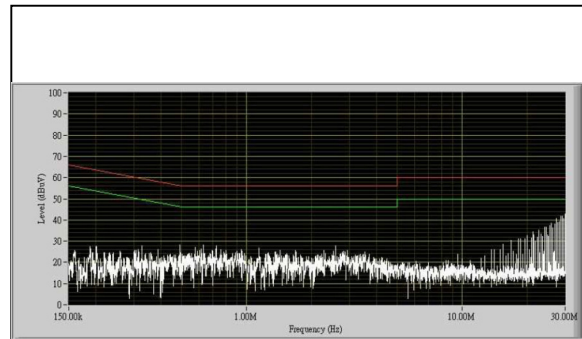

Figure 30: AXA00B18-L Conduction Emission of EN550122 Class B  
 Vin = 24Vdc Load: Io = 0.83A

Note - All test conditions are at 25 °C

## AXA00C18-L Performance Curves

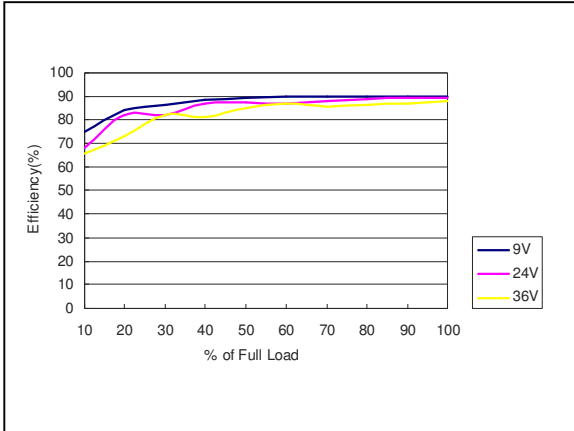

Figure 31: AXA00C18-L Efficiency Versus Output Current Curve  
 Vin = 9 to 36Vdc Load: Io = 0 to 0.67A

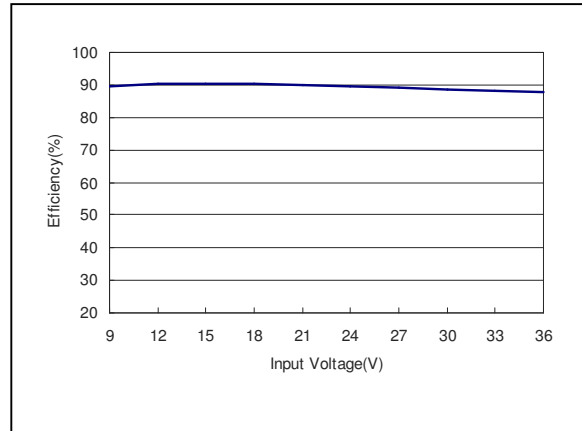

Figure 32: AXA00C18-L Efficiency Versus Input Voltage Curve  
 Vin = 9 to 36Vdc Load: Io = 0.67A

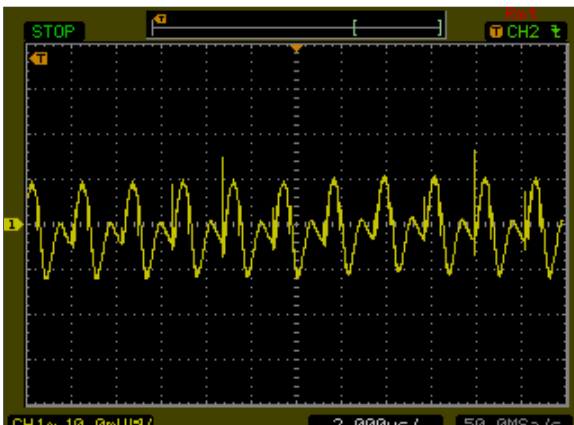

Figure 33: AXA00C18-L Ripple and Noise Measurement  
 Vin = 24Vdc Load: Io = 0.67A  
 Ch 1: Vo

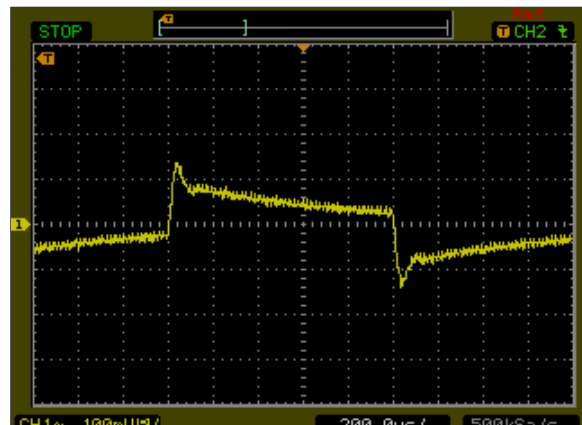

Figure 34: AXA00C18-L Transient Response  
 Vin = 24Vdc Load: Io = 100% to 75% load change  
 Ch 1: Vo

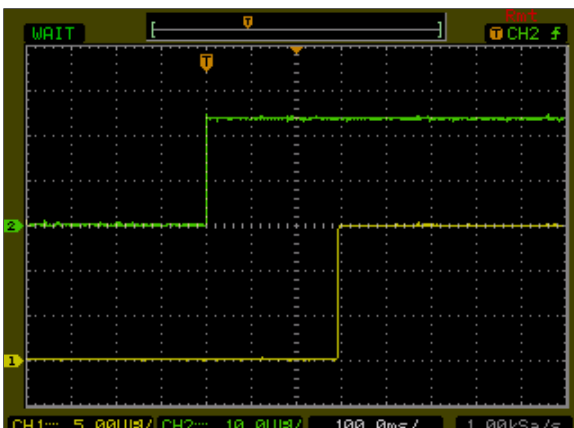

Figure 35: AXA01C18-L Output Voltage Startup Characteristic by ON/OFF  
 Vin = 24Vdc Load: Io = 1.33A  
 Ch1: Vo Ch2: Remote On/Off

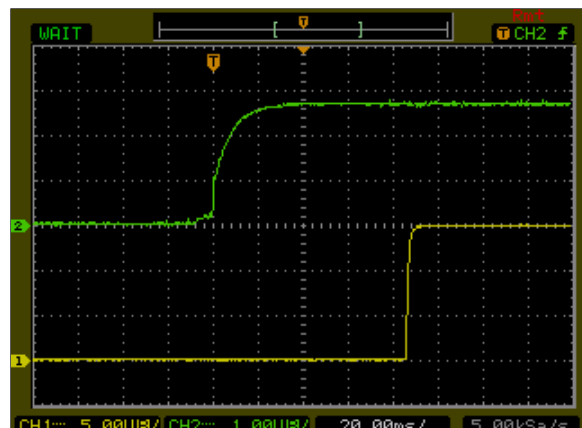

Figure 36: AXA01C18-L Output Voltage Startup Characteristic by Vin  
 Vin = 24Vdc Load: Io = 1.33A  
 Ch1: Vo Ch2: Vin

## AXA00C18-L Performance Curves

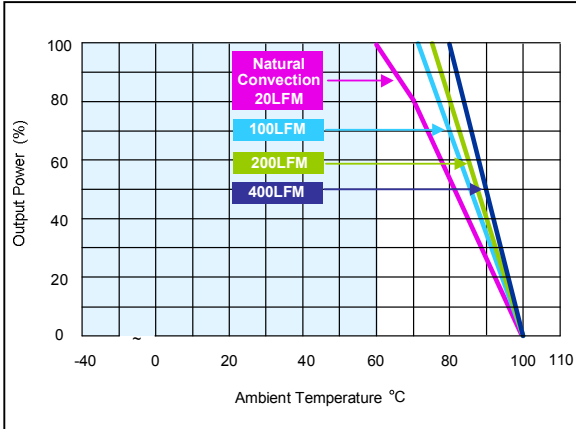

Figure 37: AXA00C18-L Derating Curves (without heatsink)  
 Vin = 24Vdc Load: Io = 0 to 0.67A

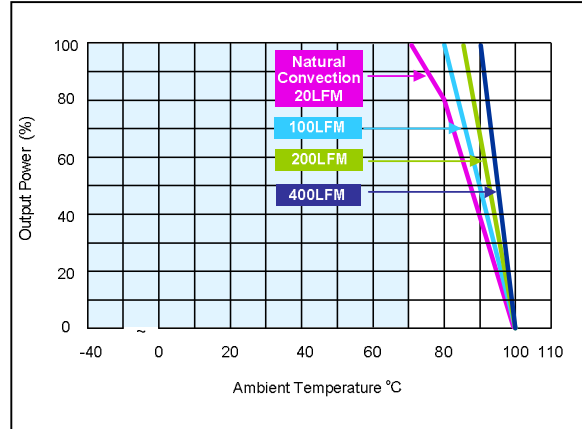

Figure 38: AXA00C18-L Derating Curves (with heatsink)  
 Vin = 24Vdc Load: Io = 0 to 0.67A

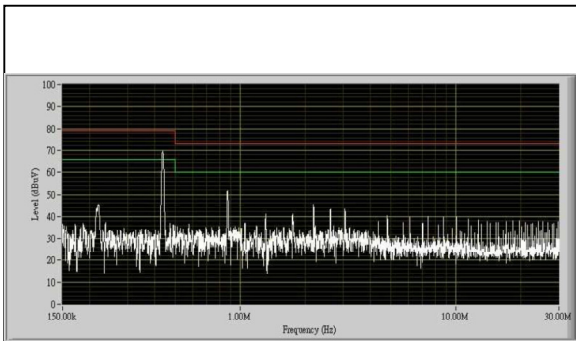

Figure 39: AXA00C18-L Conduction Emission of EN550122 Class A  
 Vin = 24Vdc Load: Io = 0.67A

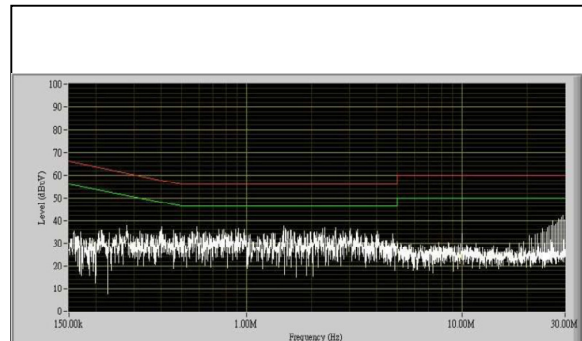

Figure 40: AXA00C18-L Conduction Emission of EN550122 Class B  
 Vin = 24Vdc Load: Io = 0.67A

Note - All test conditions are at 25 °C



## AXA000H18-L Performance Curves

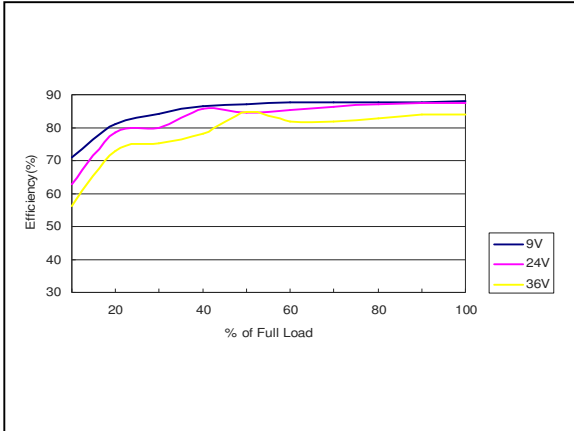

Figure 41: AXA000H18-L Efficiency Versus Output Current Curve  
 Vin = 9 to 36Vdc Load: Io = 0 to 0.41A

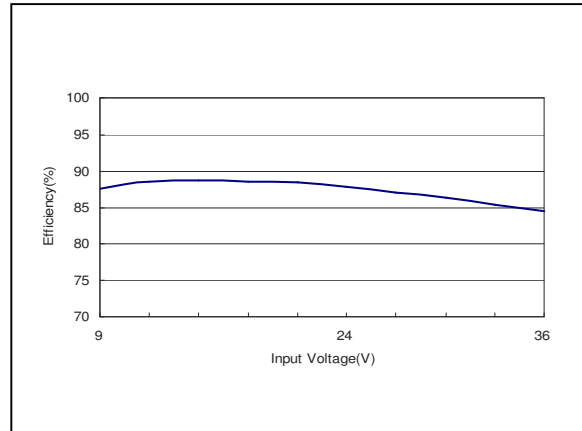

Figure 42: AXA000H18-L Efficiency Versus Input Voltage Curve  
 Vin = 9 to 36Vdc Load: Io = 0.41A

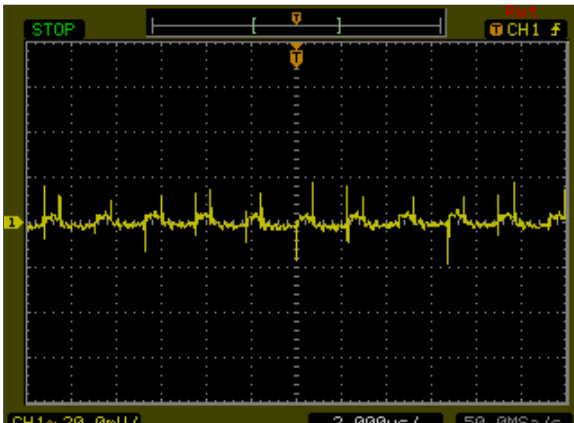

Figure 43: AXA000H18-L Ripple and Noise Measurement  
 Vin = 24Vdc Load: Io = 0.41A  
 Ch 1: Vo

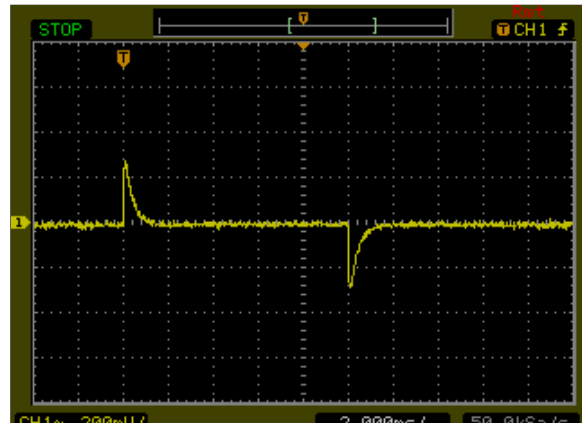

Figure 44: AXA000H18-L Transient Response  
 Vin = 24Vdc Load: Io = 100% to 75% load change  
 Ch 1: Vo

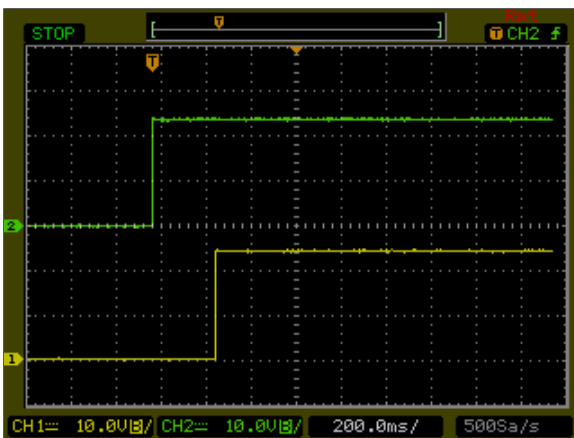

Figure 45: AXA000H18-L Output Voltage Startup Characteristic by ON/OFF  
 Vin = 24Vdc Load: Io = 0.41A  
 Ch1: Vo Ch2: Remote On/Off

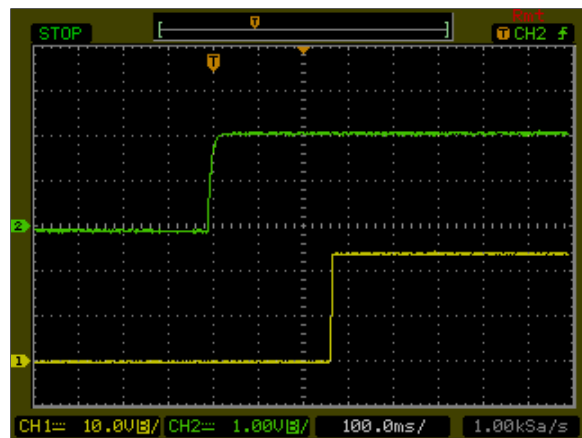

Figure 46: AXA000H18-L Output Voltage Startup Characteristic by Vin  
 Vin = 24Vdc Load: Io = 0.41A  
 Ch1: Vo Ch2: Vin

## AXA000H18-L Performance Curves

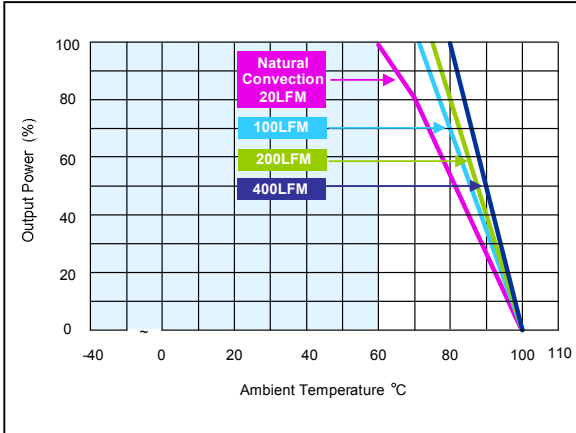

Figure 47: AXA000H18-L Derating Curves (without heatsink)  
 Vin = 24Vdc Load: Io = 0 to 0.41A

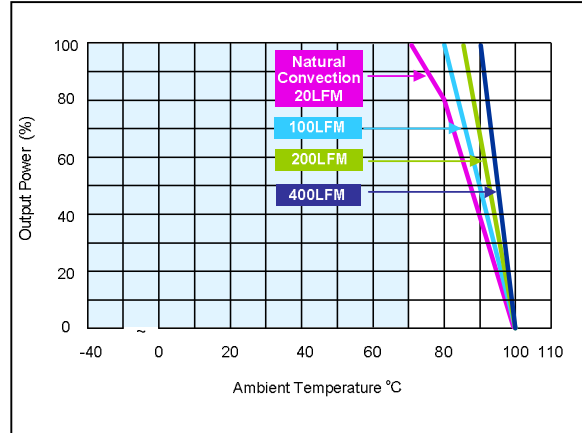

Figure 48: AXA000H18-L Derating Curves (with heatsink)  
 Vin = 24Vdc Load: Io = 0 to 0.41A

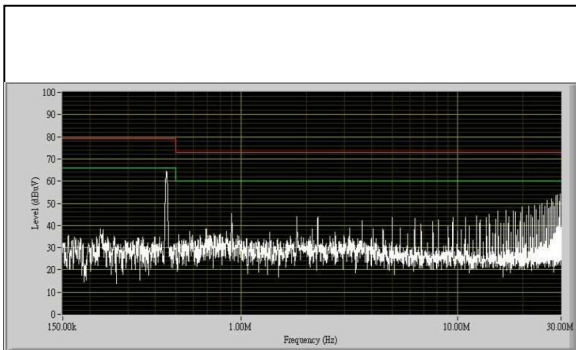

Figure 49: AXA000H18-L Conduction Emission of EN550122 Class A  
 Vin = 24Vdc Load: Io = 0.41A

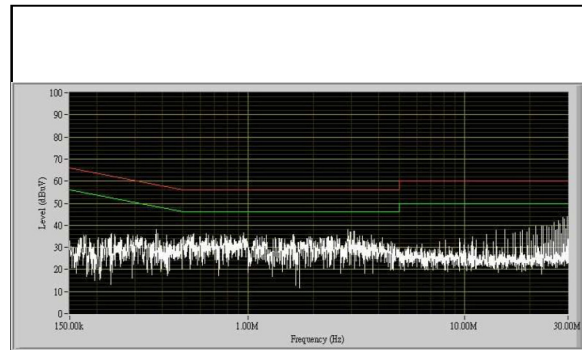

Figure 50: AXA000H18-L Conduction Emission of EN550122 Class B  
 Vin = 24Vdc Load: Io = 0.41A

Note - All test conditions are at 25 °C

## AXA00AA18-L Performance Curves

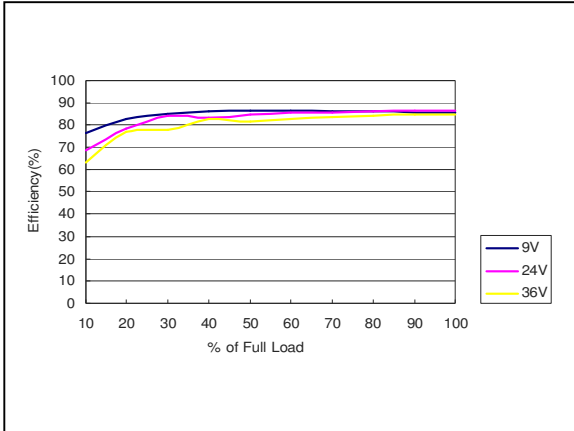

Figure 51: AXA00AA18-L Efficiency Versus Output Current Curve  
 Vin = 9 to 36Vdc Load: Io = 0 to ±1 A

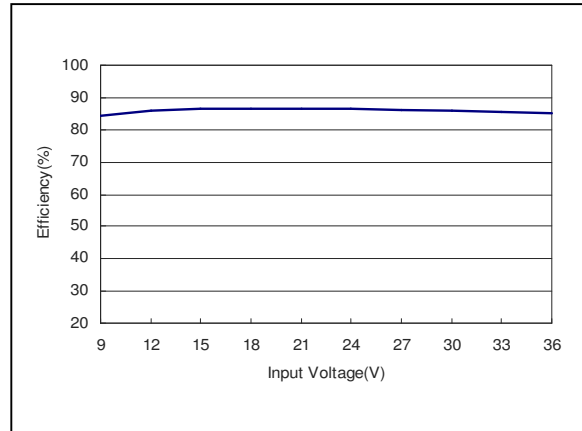

Figure 52: AXA00AA18-L Efficiency Versus Input Voltage Curve  
 Vin = 9 to 36Vdc Load: Io = ±1 A



Figure 53: AXA00AA18-L Ripple and Noise Measurement  
 Vin = 24Vdc Load: Io = ±1 A  
 Ch 1: Vo1 Ch2: Vo2

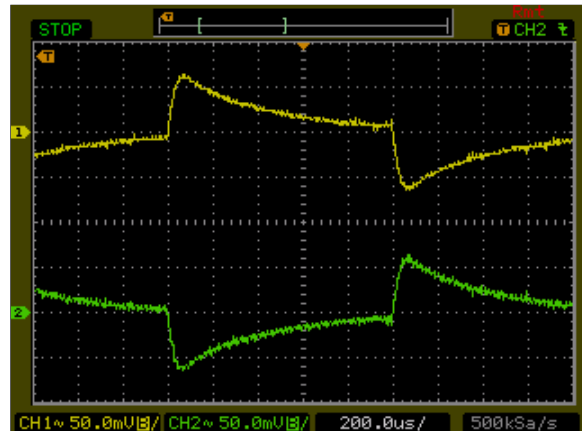

Figure 54: AXA00AA18-L Transient Response  
 Vin = 24Vdc Load: Io = 100% to 75% load change  
 Ch 1: Vo1 Ch2: Vo2

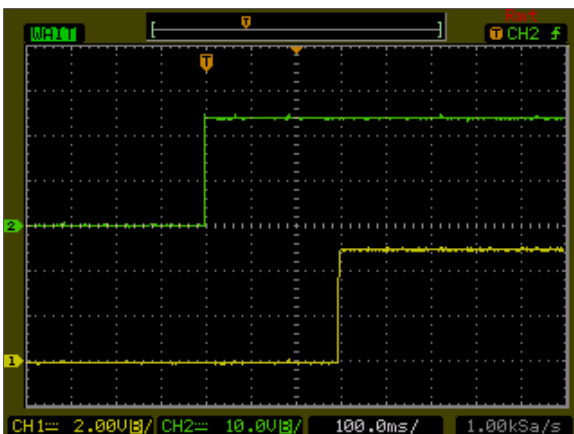

Figure 55: AXA00AA18-L Output Voltage Startup Characteristic by ON/OFF  
 Vin = 24Vdc Load: Io = ±1 A  
 Ch1: Vo Ch2: Remote On/Off

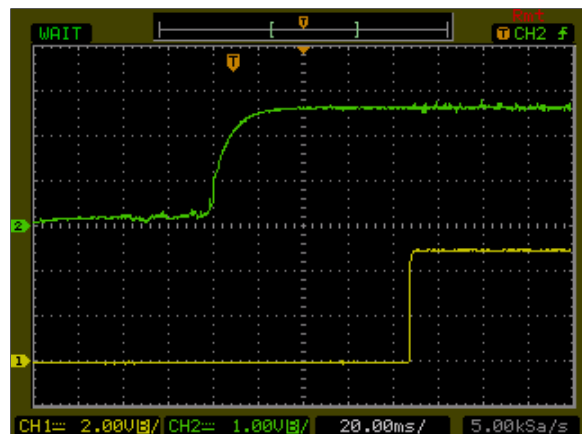

Figure 56: AXA00AA18-L Output Voltage Startup Characteristic by Vin  
 Vin = 24Vdc Load: Io = ±1 A  
 Ch1: Vo Ch2: Vin

## AXA00AA18-L Performance Curves

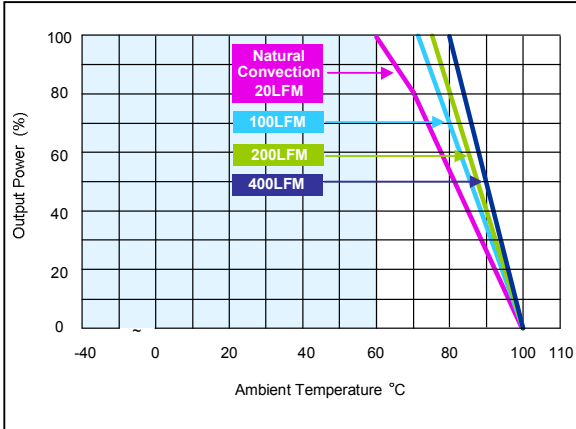

Figure 57: AXA00AA18-L Derating Curves (without heatsink)  
 Vin = 24Vdc Load: Io = 0 to ±1 A

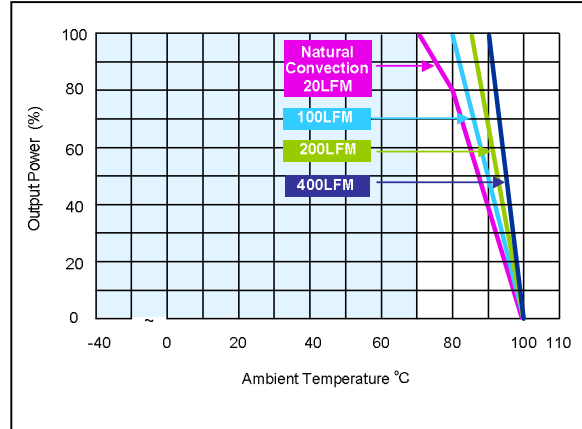

Figure 58: AXA00AA18-L Derating Curves (with heatsink)  
 Vin = 24Vdc Load: Io = 0 to ±1 A

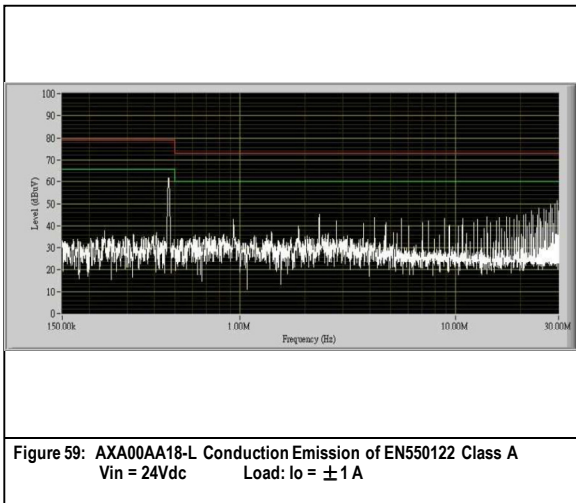

Figure 59: AXA00AA18-L Conduction Emission of EN550122 Class A  
 Vin = 24Vdc Load: Io = ±1 A

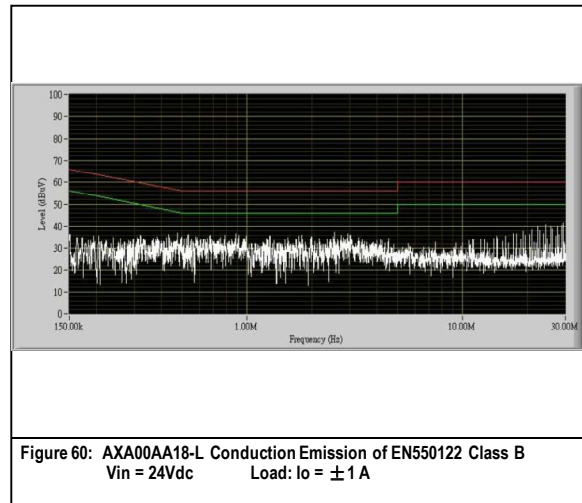

Figure 60: AXA00AA18-L Conduction Emission of EN550122 Class B  
 Vin = 24Vdc Load: Io = ±1 A

Note - All test conditions are at 25 °C

## AXA000BB18-L Performance Curves

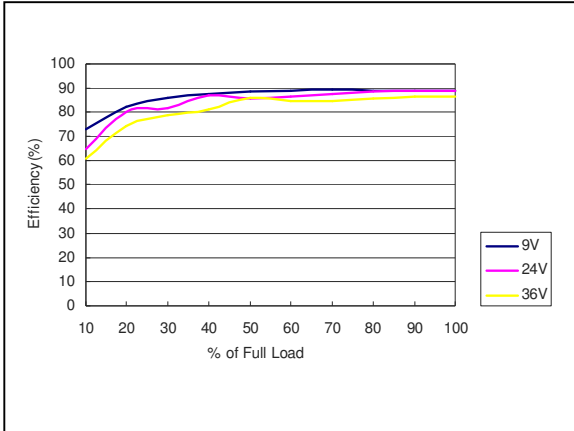

Figure 61: AXA000BB18-L Efficiency Versus Output Current Curve  
 Vin = 9 to 36Vdc Load: Io = 0 to ±0.41 A

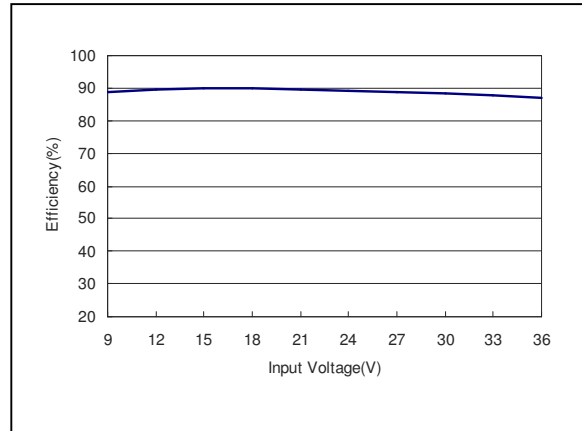

Figure 62: AXA000BB18-L Efficiency Versus Input Voltage Curve  
 Vin = 9 to 36Vdc Load: Io = ±0.41 A

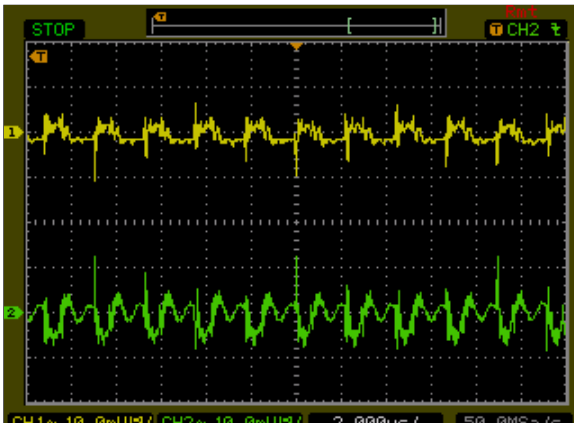

Figure 63: AXA000BB18-L Ripple and Noise Measurement  
 Vin = 24Vdc Load: Io = ±0.41 A  
 Ch 1: Vo1 Ch 2: Vo2

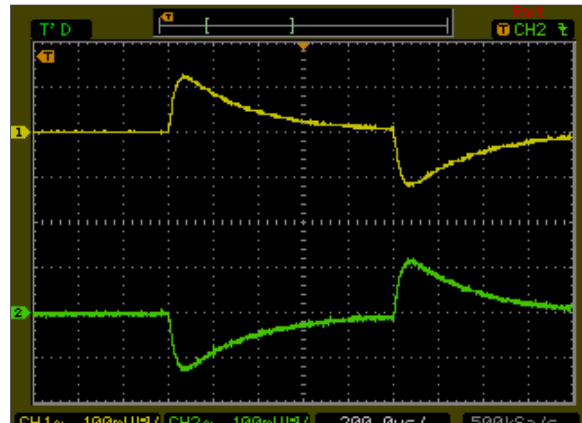

Figure 64: AXA000BB18-L Transient Response  
 Vin = 24Vdc Load: Io = 100% to 75% load change  
 Ch 1: Vo1 Ch 2: Vo2

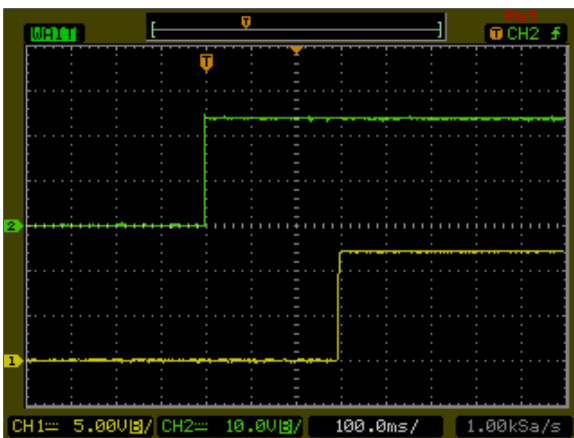

Figure 66: AXA000BB18-L Output Voltage Startup Characteristic by ON/OFF  
 Vin = 24Vdc Load: Io = ±0.41 A  
 Ch1: Vo Ch2: Remote On/Off

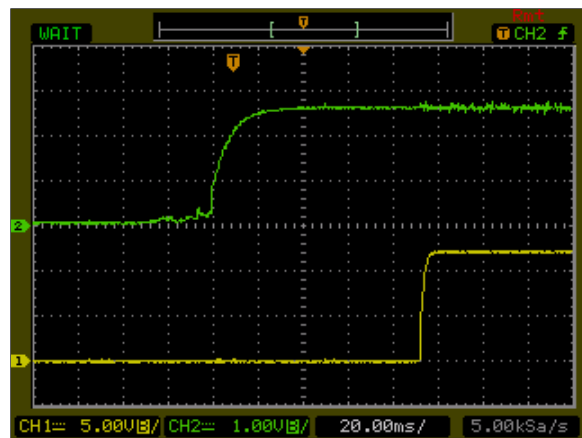

Figure 65: AXA000BB18-L Output Voltage Startup Characteristic by Vin  
 Vin = 24Vdc Load: Io = ±0.41 A  
 Ch1: Vo Ch2: Vin

## AXA000BB18-L Performance Curves

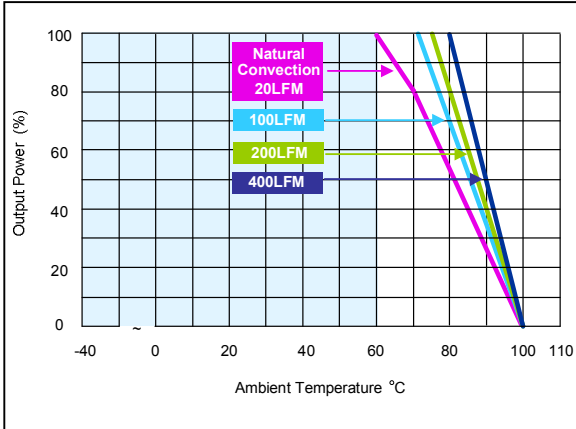

Figure 67: AXA000BB18-L Derating Curves (without heatsink)  
 Vin = 24Vdc Load: Io = 0 to ±0.41 A

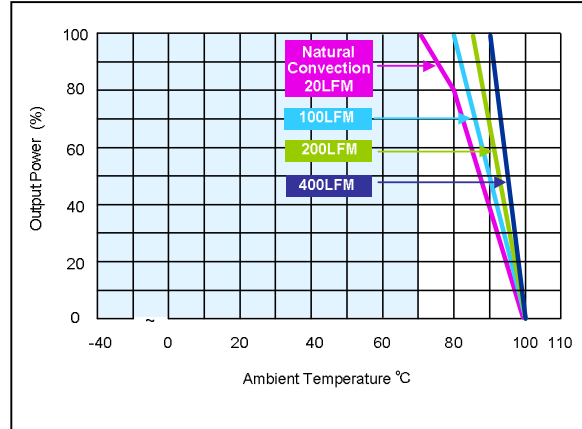

Figure 68: AXA000BB18-L Derating Curves (with heatsink)  
 Vin = 24Vdc Load: Io = 0 to ±0.41 A

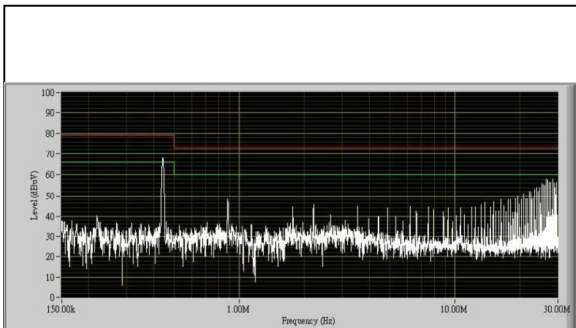

Figure 69: AXA000BB18-L Conduction Emission of EN550122 Class A  
 Vin = 24Vdc Load: Io = ±0.41 A

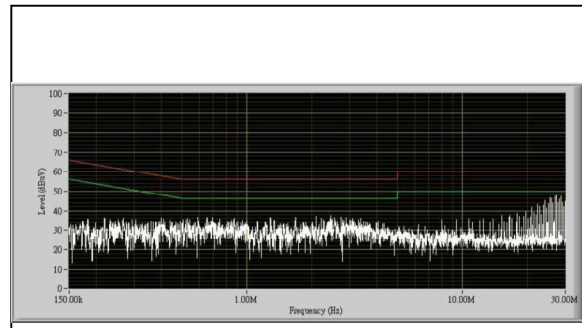

Figure 70: AXA000BB18-L Conduction Emission of EN550122 Class B  
 Vin = 24Vdc Load: Io = ±0.41 A

Note - All test conditions are at 25 °C

## AXA000CC18-L Performance Curves

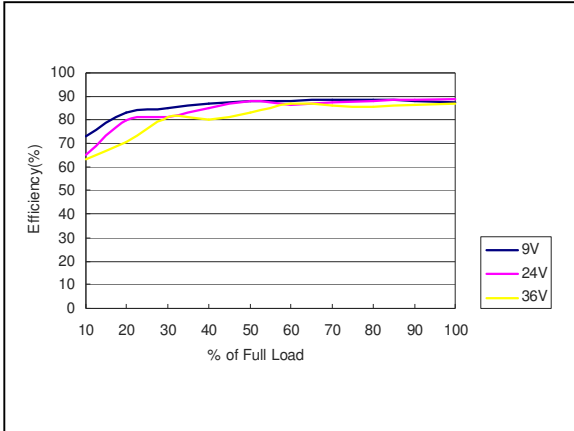

Figure 71: AXA000CC18-L Efficiency Versus Output Current Curve  
 Vin = 9 to 36Vdc Load: Io = 0 to ±0.33 A

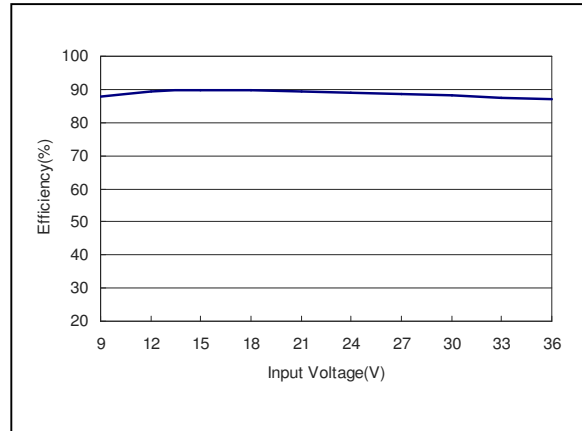

Figure 72: AXA000CC18-L Efficiency Versus Input Voltage Curve  
 Vin = 9 to 36Vdc Load: Io = ±0.33 A

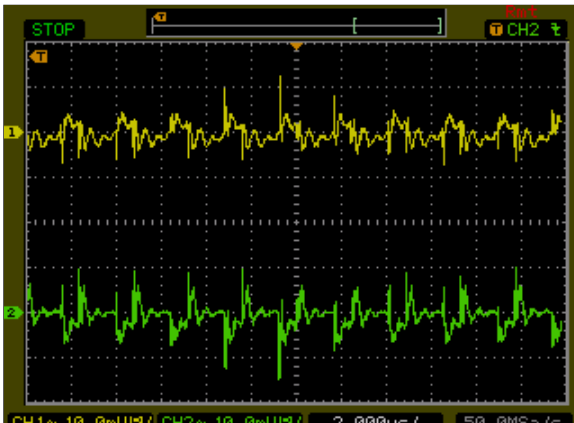

Figure 73: AXA000CC18-L Ripple and Noise Measurement  
 Vin = 24Vdc Load: Io = ±0.33 A  
 Ch 1: Vo1 Ch2: Vo2

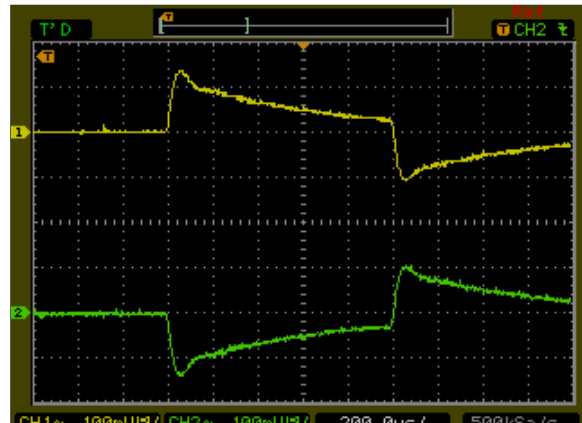

Figure 74: AXA000CC18-L Transient Response  
 Vin = 24Vdc Load: Io = 100% to 75% load change  
 Ch 1: Vo1 Ch2: Vo2

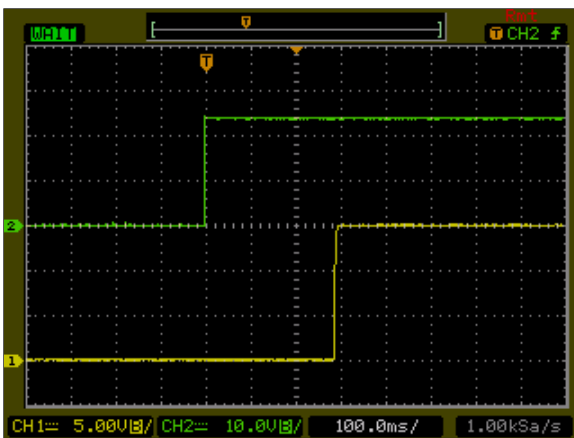

Figure 75: AXA000CC18-L Output Voltage Startup Characteristic by ON/OFF  
 Vin = 24Vdc Load: Io = ±0.33 A  
 Ch1: Vo Ch2: Remote On/Off

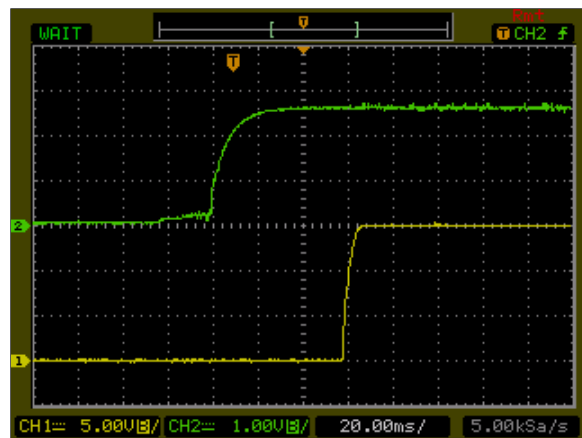

Figure 76: AXA000CC18-L Output Voltage Startup Characteristic by Vin  
 Vin = 24Vdc Load: Io = ±0.33 A  
 Ch1: Vo Ch2: Vin



## AXA000CC18-L Performance Curves

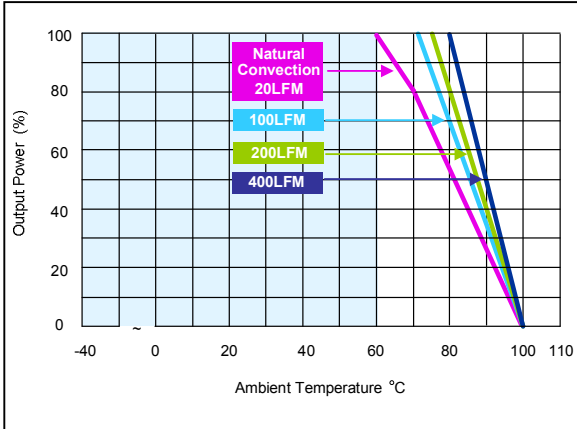

Figure 77: AXA000CC18-L Derating Curves (without heatsink)  
 Vin = 24Vdc Load: Io = 0 to ±0.33 A

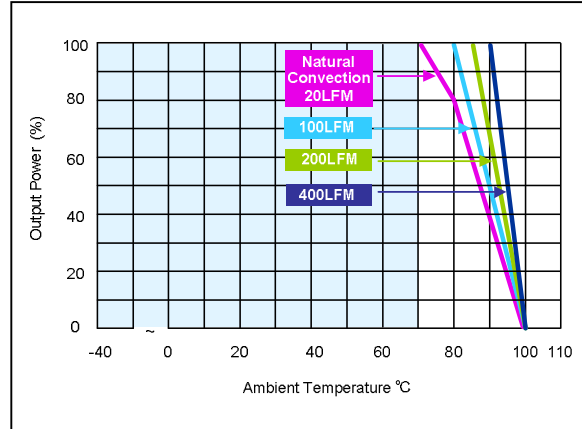

Figure 78: AXA000CC18-L Derating Curves (with heatsink)  
 Vin = 24Vdc Load: Io = 0 to ±0.33 A

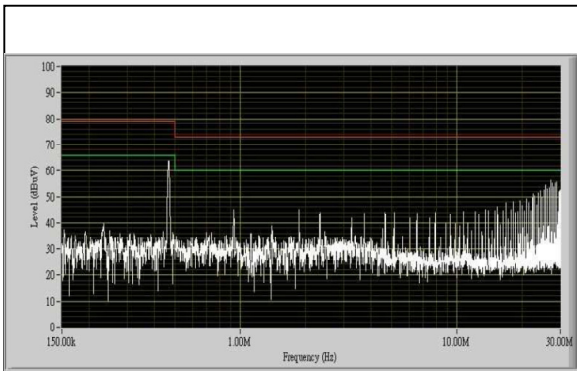

Figure 79: AXA000CC18-L Conduction Emission of EN550122 Class A  
 Vin = 24Vdc Load: Io = ±0.33 A

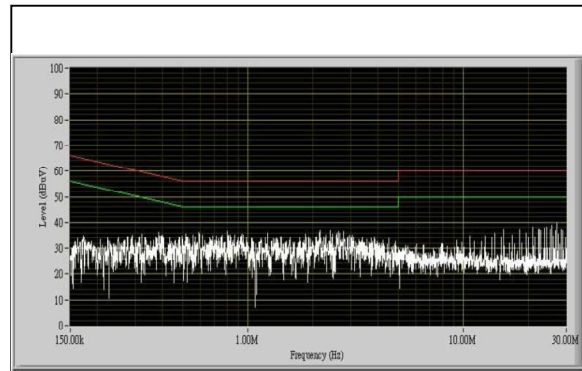

Figure 80: AXA000CC18-L Conduction Emission of EN550122 Class B  
 Vin = 24Vdc Load: Io = ±0.33 A

Note - All test conditions are at 25 °C

## AXA02F36-L Performance Curves

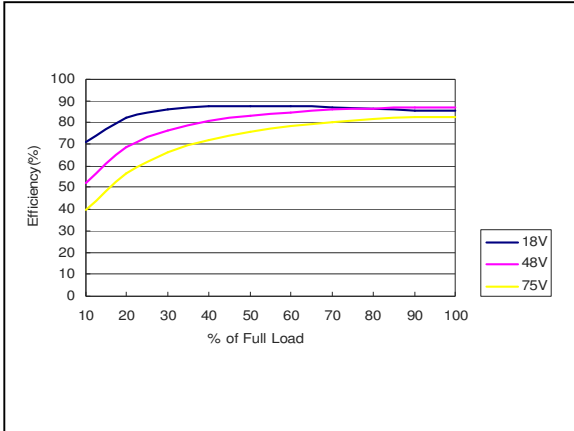

Figure 81: AXA02F36-L Efficiency Versus Output Current Curve  
 Vin = 18 to 75Vdc Load: Io = 0 to 2.2A

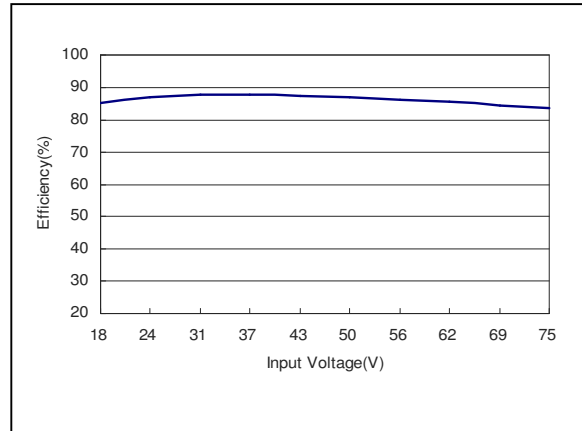

Figure 82: AXA02F36-L Efficiency Versus Input Voltage Curve  
 Vin = 18 to 75Vdc Load: Io = 2.2 A

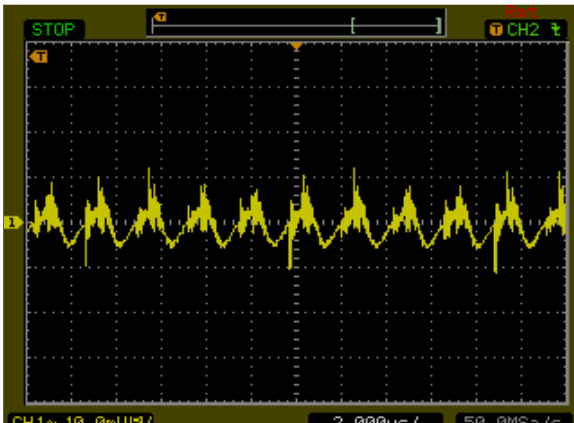

Figure 83: AXA02F36-L Ripple and Noise Measurement  
 Vin = 48Vdc Load: Io = 2.2A  
 Ch 1: Vo

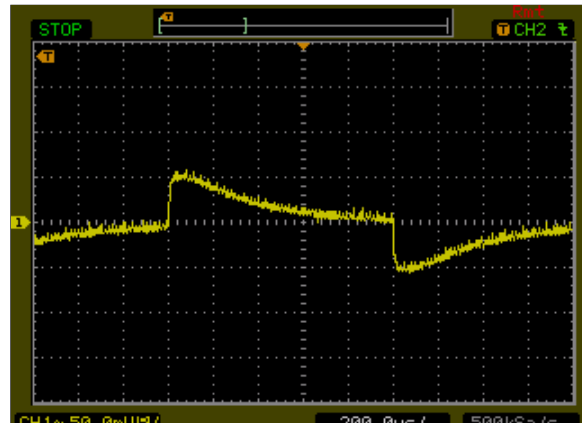

Figure 84: AXA02F36-L Transient Response  
 Vin = 48Vdc Load: Io = 100% to 75% load change  
 Ch 1: Vo

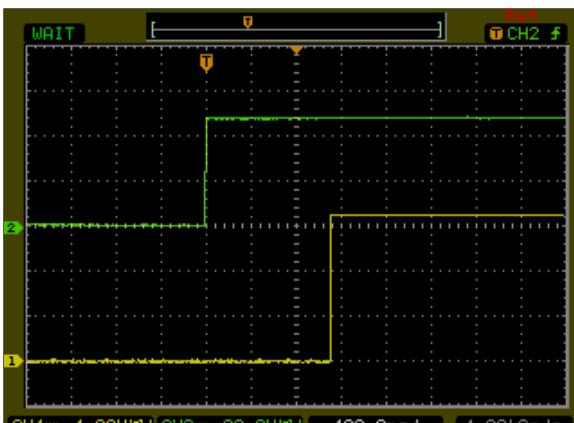

Figure 85: AXA02F36-L Output Voltage Startup Characteristic by ON/OFF  
 Vin = 48Vdc Load: Io = 2.2A  
 Ch1: Vo Ch2: Remote On/Off

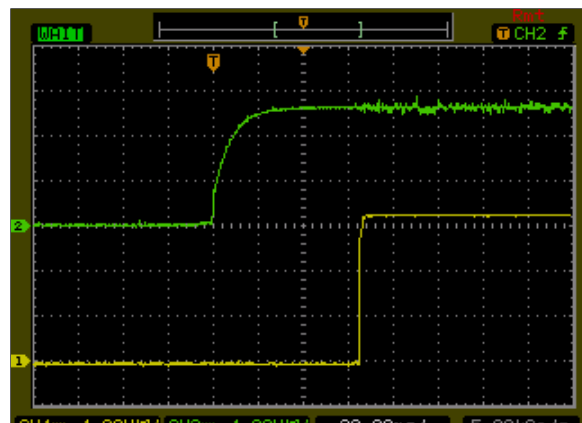

Figure 86: AXA02F36-L Output Voltage Startup Characteristic by Vin  
 Vin = 48Vdc Load: Io = 2.2A  
 Ch1: Vo Ch2: Vin

## AXA02F36-L Performance Curves

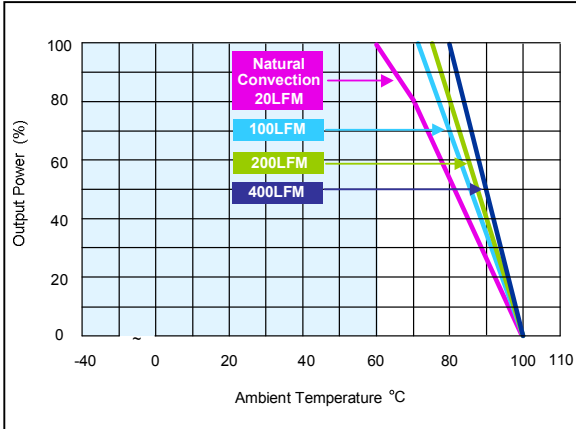

Figure 87: AXA02F36-L Derating Curves (without heatsink)  
 Vin = 48Vdc Load: Io = 0 to 2.2A

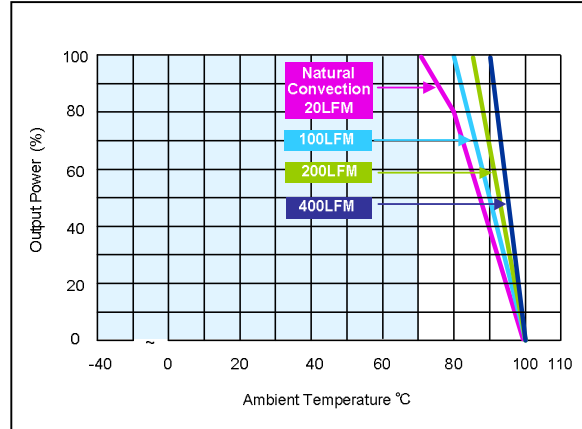

Figure 88: AXA02F36-L Derating Curves (with heatsink)  
 Vin = 48Vdc Load: Io = 2.2A

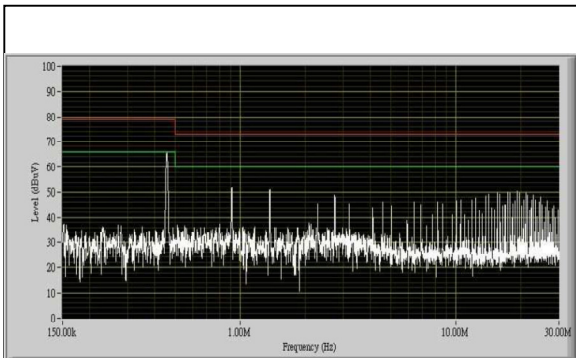

Figure 89: AXA02F36-L Conduction Emission of EN550122 Class A  
 Vin = 24Vdc Load: Io = 2.2A

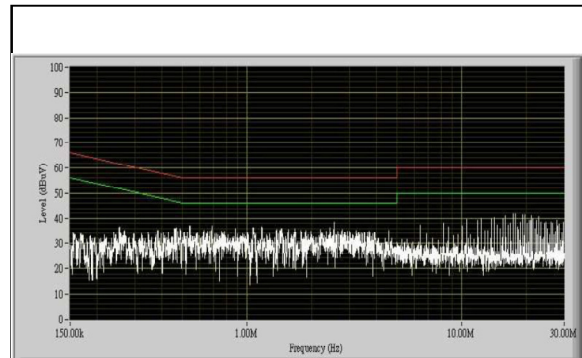

Figure 90: AXA02F36-L Conduction Emission of EN550122 Class B  
 Vin = 24Vdc Load: Io = 2.2A

Note - All test conditions are at 25 °C

## AXA02A36-L Performance Curves

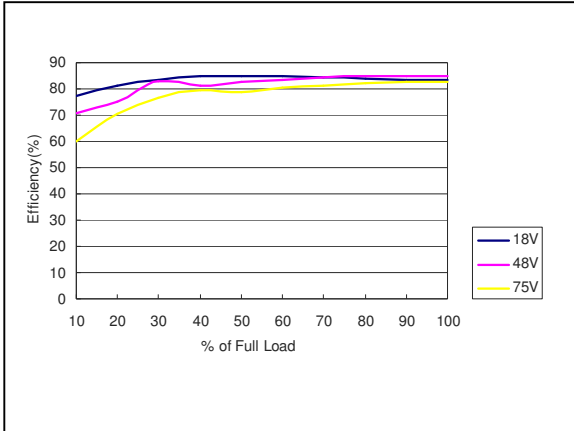

Figure 91: AXA02A36-L Efficiency Versus Output Current Curve  
 Vin = 18 to 75Vdc Load: Io = 0 to 2A

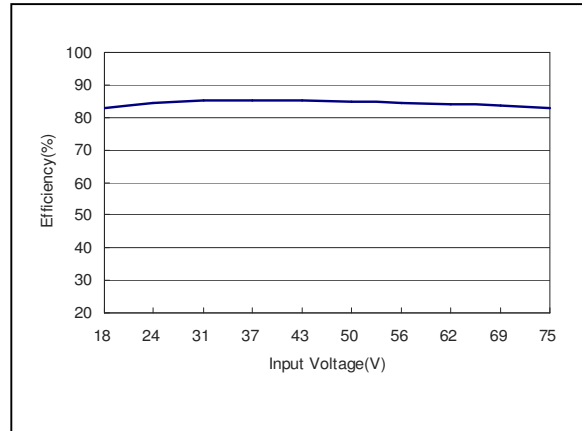

Figure 92: AXA02A36-L Efficiency Versus Input Voltage Curve  
 Vin = 18 to 75Vdc Load: Io = 2A

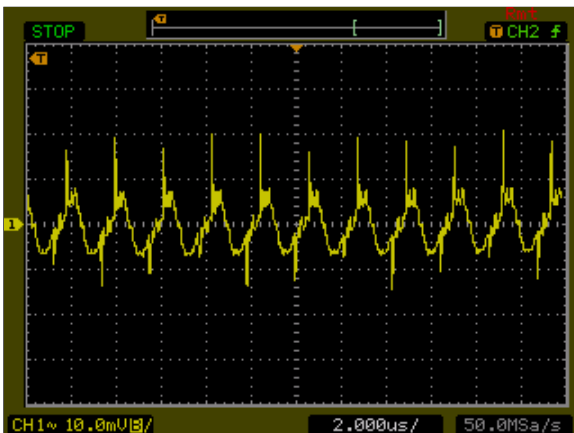

Figure 93: AXA02A36-L Ripple and Noise Measurement  
 Vin = 48Vdc Load: Io = 2A  
 Ch 1: Vo

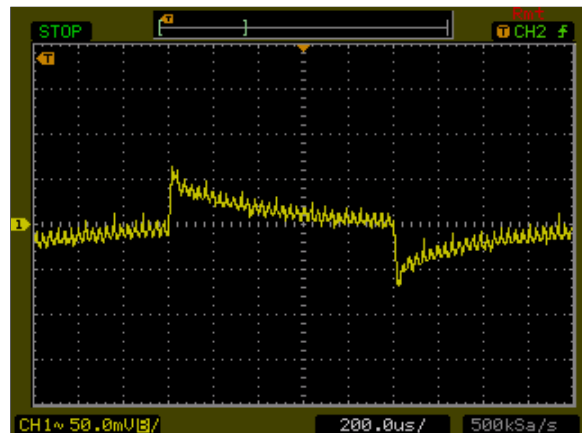

Figure 94: AXA02A36-L Transient Response  
 Vin = 48Vdc Load: Io = 100% to 75% load change  
 Ch 1: Vo

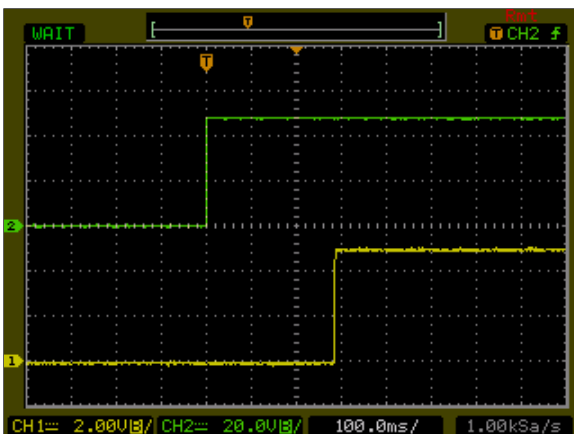

Figure 95: AXA02A36-L Output Voltage Startup Characteristic by ON/OFF  
 Vin = 48Vdc Load: Io = 2A  
 Ch1: Vo Ch2: Remote On/Off

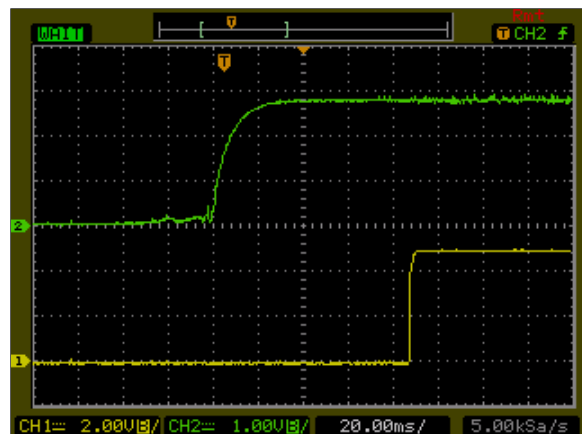

Figure 96: AXA02A36-L Output Voltage Startup Characteristic by Vin  
 Vin = 48Vdc Load: Io = 2A  
 Ch1: Vo Ch2: Vin

## AXA02A36-L Performance Curves

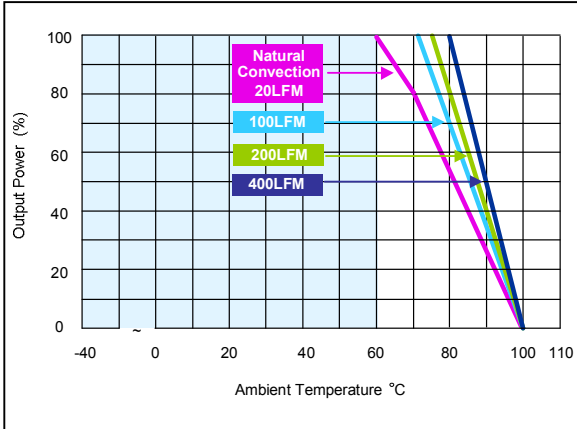

Figure 97: AXA02A36-L Derating Curves (without heatsink)  
 Vin = 48Vdc Load: Io = 0 to 2A

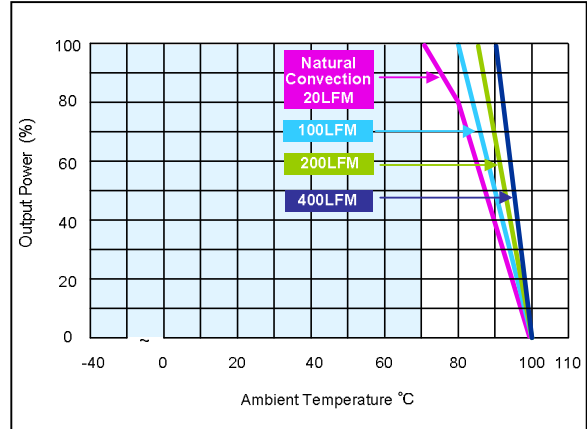

Figure 98: AXA02A36-L Derating Curves (with heatsink)  
 Vin = 48Vdc Load: Io = 0 to 2A

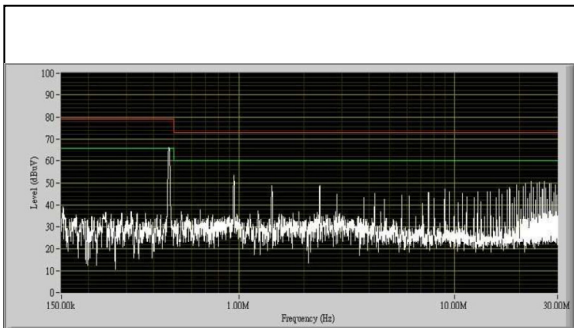

Figure 99: AXA02A36-L Conduction Emission of EN550122 Class A  
 Vin = 48Vdc Load: Io = 2A

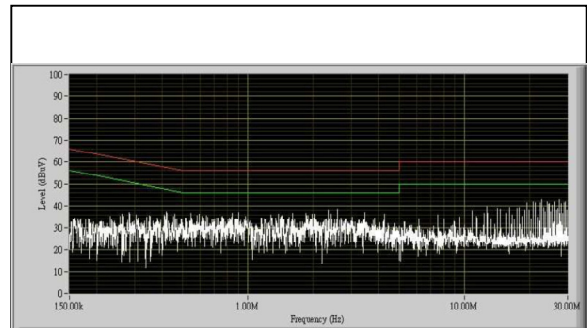

Figure 100: AXA02A36-L Conduction Emission of EN550122 Class B  
 Vin = 48Vdc Load: Io = 2A

Note - All test conditions are at 25 °C

## AXA00B36-L Performance Curves

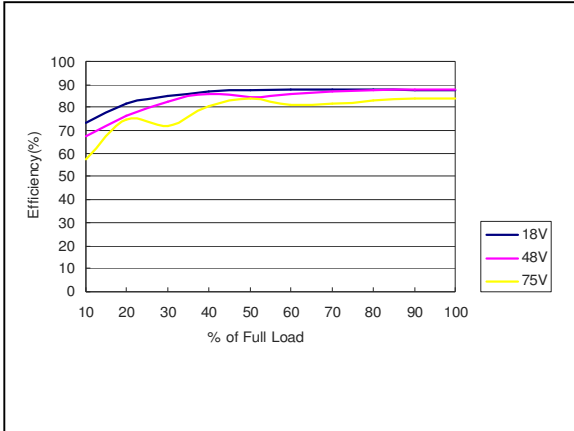

Figure 101: AXA00B36-L Efficiency Versus Output Current Curve  
 Vin = 18 to 75Vdc Load: Io = 0 to 0.83A

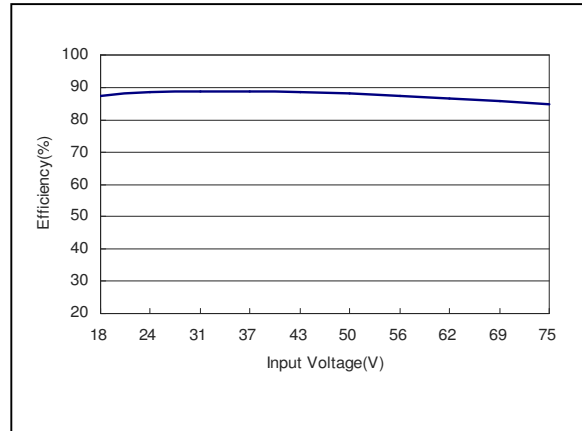

Figure 102: AXA00B36-L Efficiency Versus Input Voltage Curve  
 Vin = 18 to 75Vdc Load: Io = 0.83A

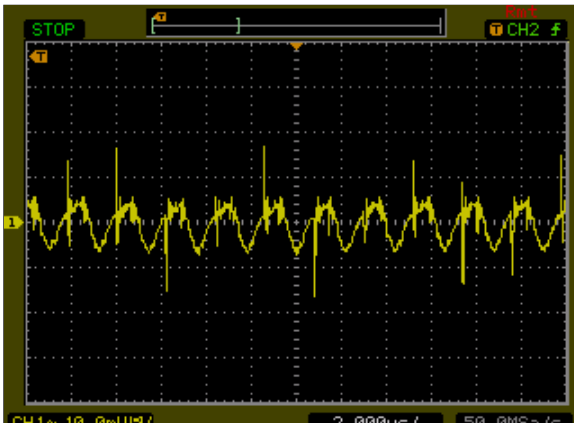

Figure 103: AXA00B36-L Ripple and Noise Measurement  
 Vin = 48Vdc Load: Io = 0.83A  
 Ch 1: Vo

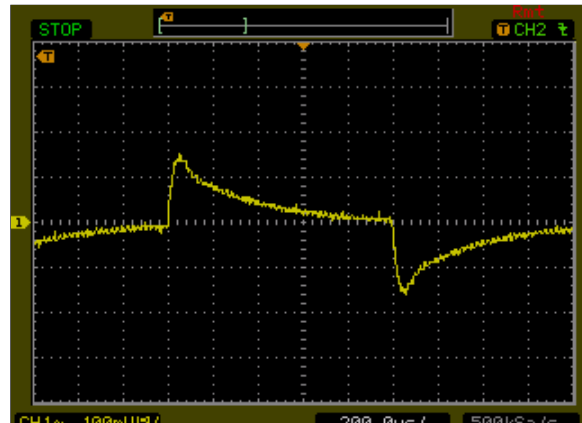

Figure 104: AXA00B36-L Transient Response  
 Vin = 48Vdc Load: Io = 100% to 75% load change  
 Ch 1: Vo

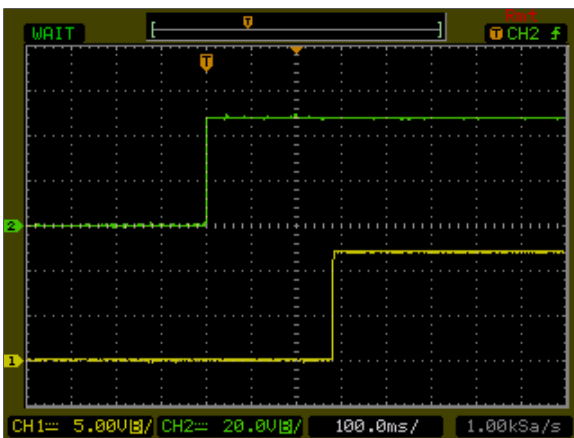

Figure 105: AXA00B36-L Output Voltage Startup Characteristic by ON/OFF  
 Vin = 48Vdc Load: Io = 0.83A  
 Ch1: Vo Ch2: Remote On/Off

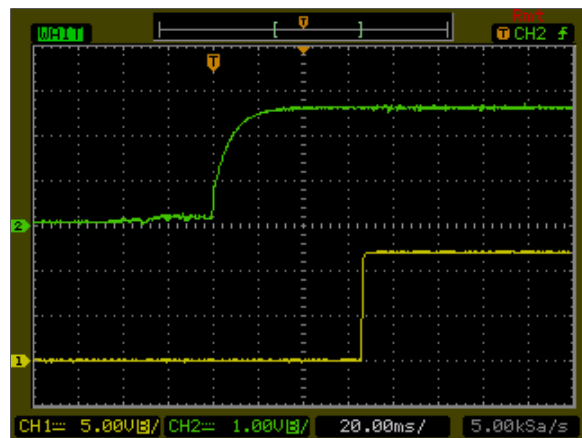

Figure 106: AXA00B36-L Output Voltage Startup Characteristic by Vin  
 Vin = 48Vdc Load: Io = 0.83A  
 Ch1: Vo Ch2: Vin

## AXA00B36-L Performance Curves

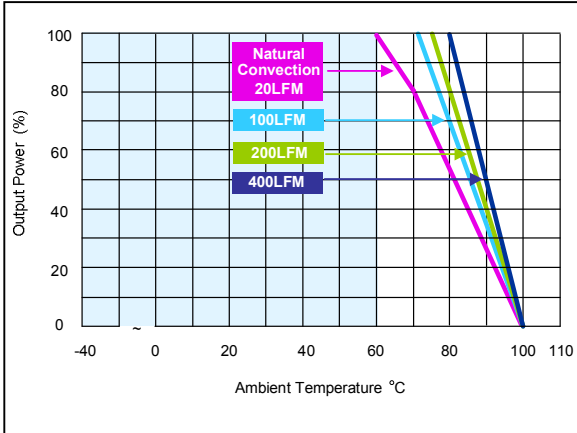

Figure 107: AXA00B36-L Derating Curves (without heatsink)  
 Vin = 48Vdc Load: Io = 0 to 0.83 A

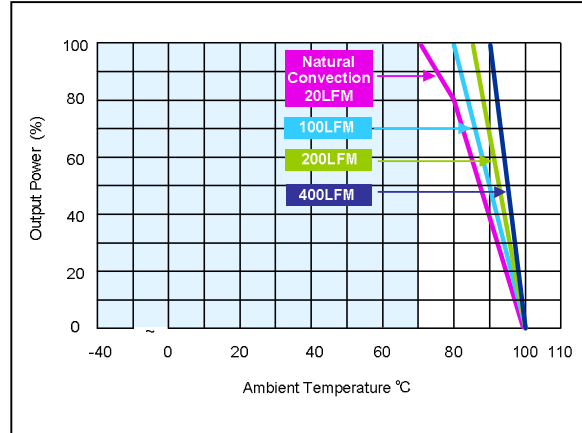

Figure 108: AXA00B36-L Derating Curves (with heatsink)  
 Vin = 48Vdc Load: Io = 0 to 0.83 A

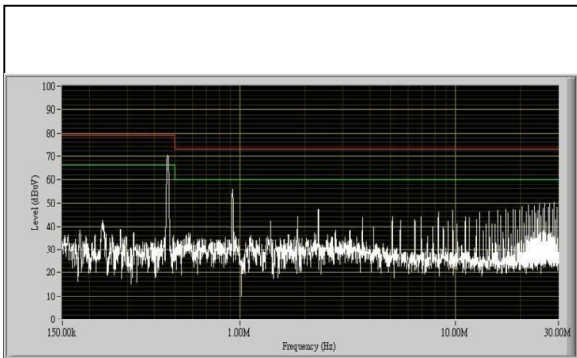

Figure 109: AXA00B36-L Conduction Emission of EN550122 Class A  
 Vin = 48Vdc Load: Io = 0.83 A

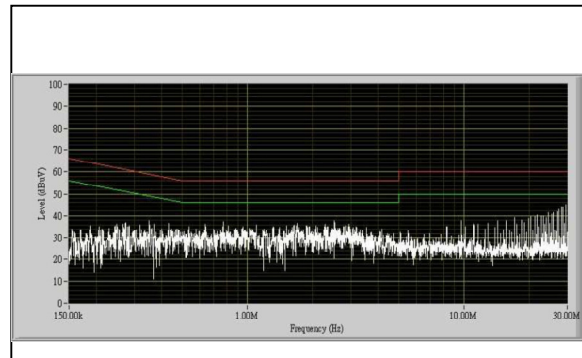

Figure 110: AXA00B36-L Conduction Emission of EN550122 Class B  
 Vin = 48Vdc Load: Io = 0.83 A

Note - All test conditions are at 25 °C



## AXA00C36-L Performance Curves

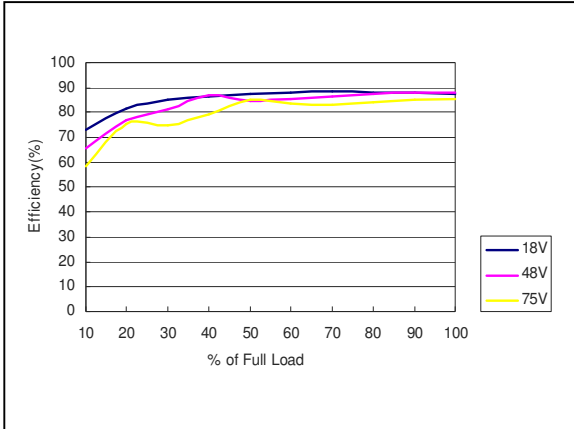

Figure 111: AXA00C36-L Efficiency Versus Output Current Curve  
 Vin = 18 to 75Vdc Load: Io = 0 to 1.33A

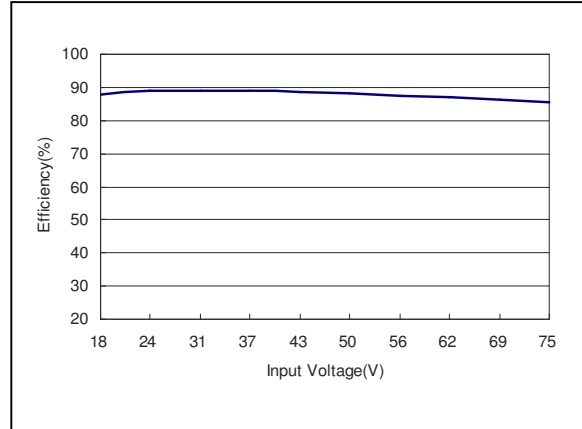

Figure 112: AXA00C36-L Efficiency Versus Input Voltage Curve  
 Vin = 18 to 75Vdc Load: Io = 0.67A

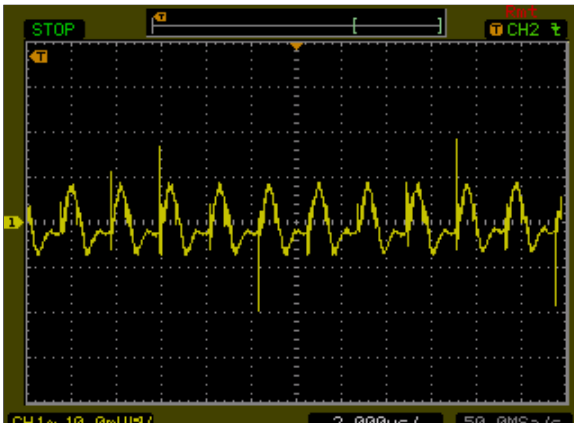

Figure 113 : AXA00C36-L Ripple and Noise Measurement  
 Vin = 48Vdc Load: Io = 0.67A  
 Ch 1: Vo

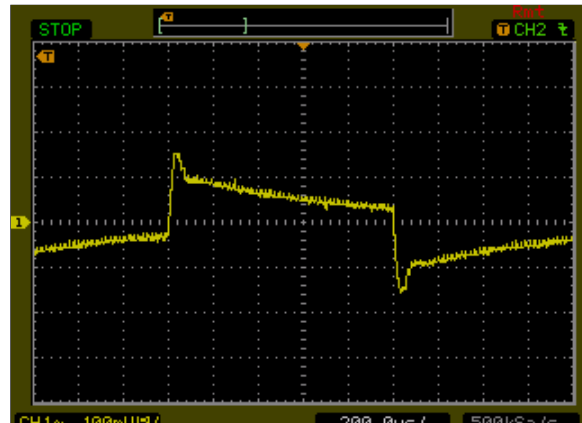

Figure 114: AXA00C36-L Transient Response  
 Vin = 48Vdc Load: Io = 100% to 75% load change  
 Ch 1: Vo

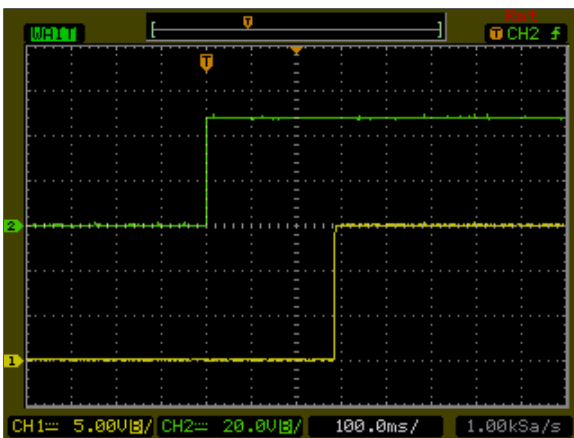

Figure 115: AXA00C36-L Output Voltage Startup Characteristic by ON/OFF  
 Vin = 48Vdc Load: Io = 0.67A  
 Ch1: Vo Ch2: Remote On/Off

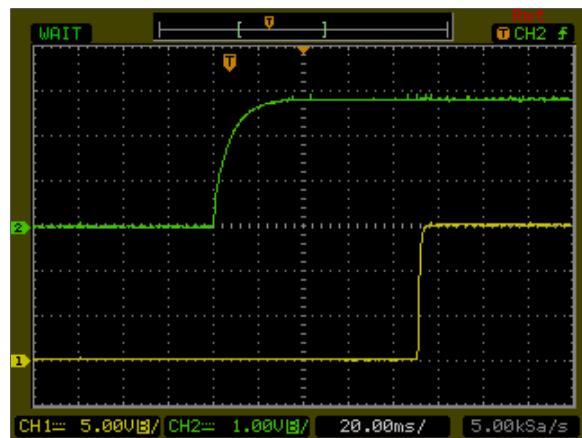

Figure 116: AXA00C36-L Output Voltage Startup Characteristic by Vin  
 Vin = 48Vdc Load: Io = 0.67A  
 Ch1: Vo Ch2: Vin

## AXA00C36-L Performance Curves

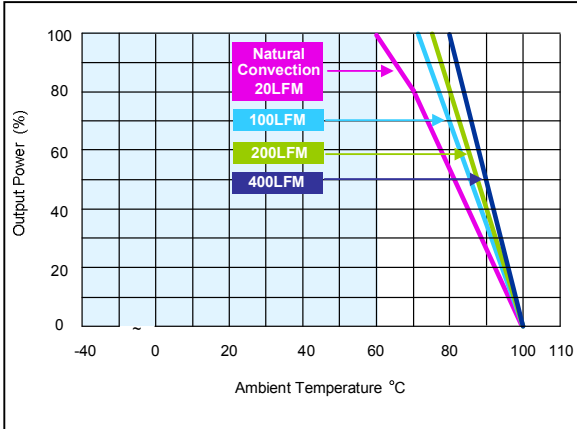

Figure 117: AXA00C36-L Derating Curves (without heatsink)  
 Vin = 48Vdc Load: Io = 0 to 0.67A

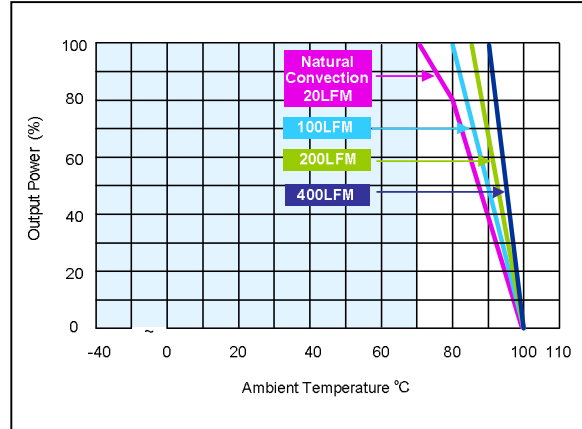

Figure 118: AXA00C36-L Derating Curves (with heatsink)  
 Vin = 48Vdc Load: Io = 0 to 0.67 A

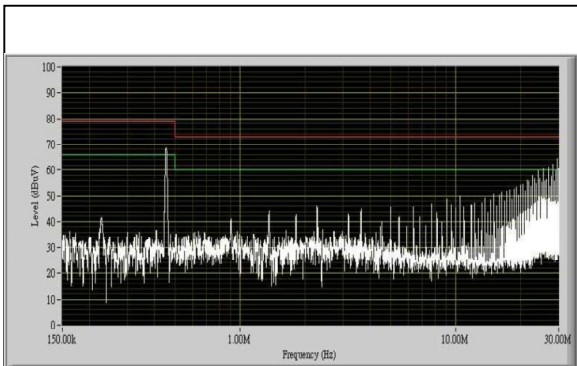

Figure 119: AXA00C36-L Conduction Emission of EN550122 Class A  
 Vin = 48Vdc Load: Io = 0.67 A

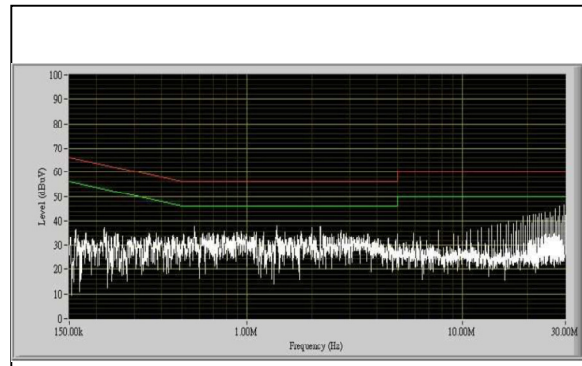

Figure 120: AXA00C36-L Conduction Emission of EN550122 Class B  
 Vin = 48Vdc Load: Io = 0.67 A

Note - All test conditions are at 25 °C

## AXA000H36-L Performance Curves

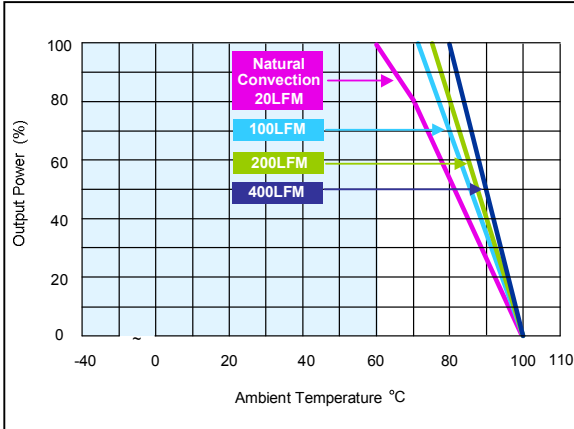

Figure 127: AXA000H36-L Derating Curves (without heatsink)  
 Vin = 48Vdc Load: Io = 0 to 0.41 A

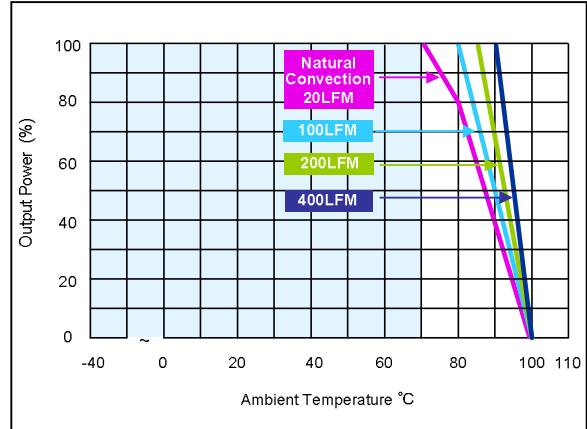

Figure 128: AXA000H36-L Derating Curves (with heatsink)  
 Vin = 48Vdc Load: Io = 0 to 0.41 A

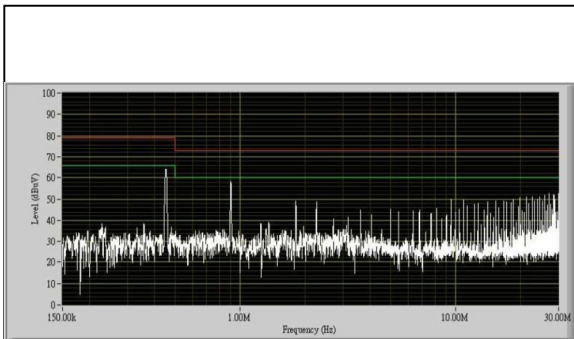

Figure 129: AXA000H36-L Conduction Emission of EN550122 Class A  
 Vin = 48Vdc Load: Io = 0.41 A

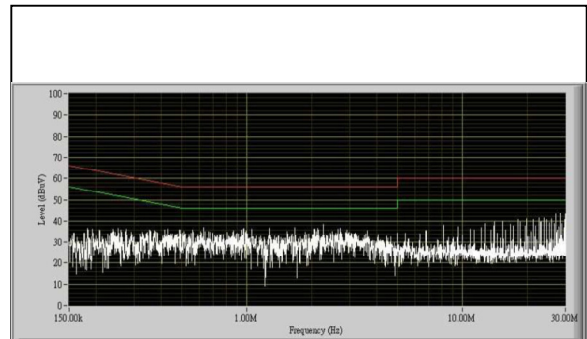

Figure 130: AXA000H36-L Conduction Emission of EN550122 Class B  
 Vin = 48Vdc Load: Io = 0.41 A

Note - All test conditions are at 25 °C

## AXA00AA36-L Performance Curves

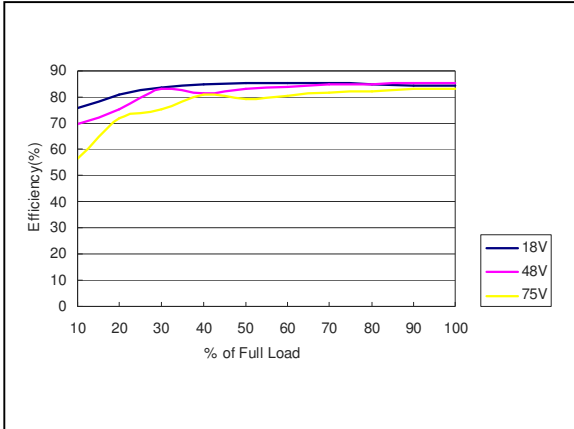

Figure 131: AXA00AA36-L Efficiency Versus Output Current Curve  
 Vin = 18 to 75Vdc Load: Io = 0 to ±1 A

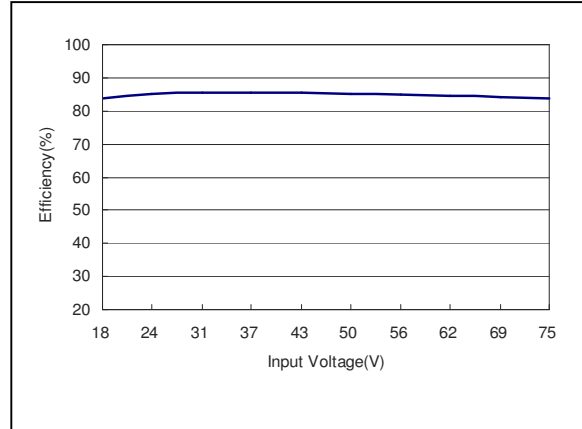

Figure 132: AXA00AA36-L Efficiency Versus Input Voltage Curve  
 Vin = 18 to 75Vdc Load: Io = ±1 A



Figure 133: AXA00AA36-L Ripple and Noise Measurement  
 Vin = 48Vdc Load: Io = ±1 A  
 Ch 1: Vo1 Ch 2: Vo2

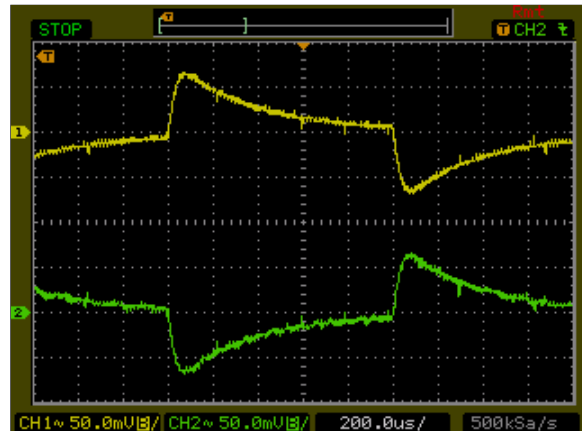

Figure 134: AXA00AA36-L Transient Response  
 Vin = 48Vdc Load: Io = 100% to 75% load change  
 Ch 1: Vo1 Ch 2: Vo2

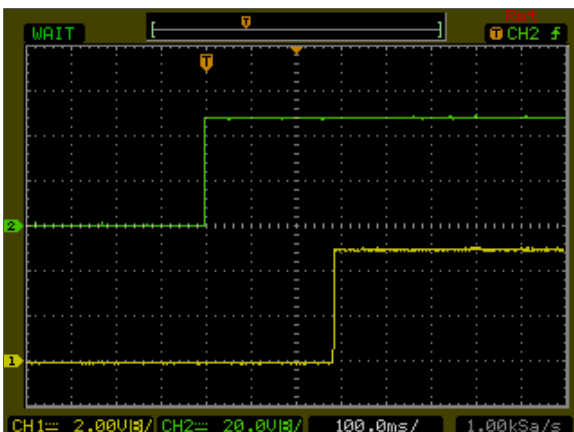

Figure 135: AXA00AA36-L Output Voltage Startup Characteristic by ON/OFF  
 Vin = 48Vdc Load: Io = ±1 A  
 Ch1: Vo Ch2: Remote On/Off

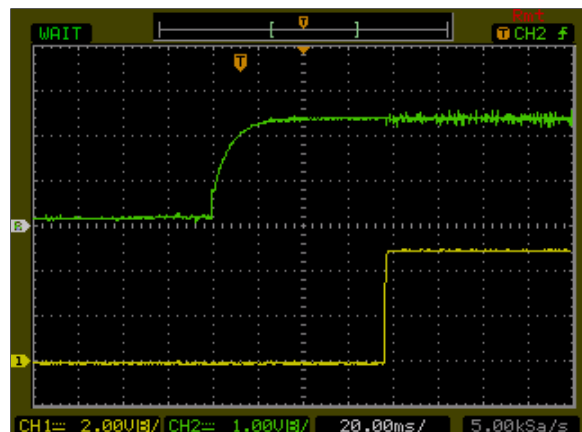

Figure 136: AXA00AA36-L Output Voltage Startup Characteristic by Vin  
 Vin = 48Vdc Load: Io = ±1 A  
 Ch1: Vo Ch2: Vin

## AXA00AA36-L Performance Curves

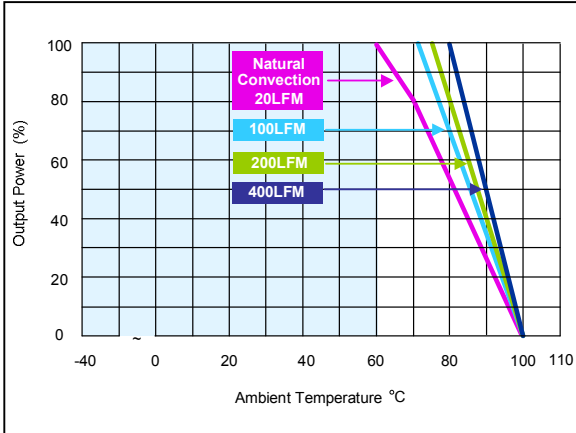

Figure 137: AXA00AA36-L Derating Curves (without heatsink)  
 Vin = 48Vdc Load: Io = 0 to ±1 A

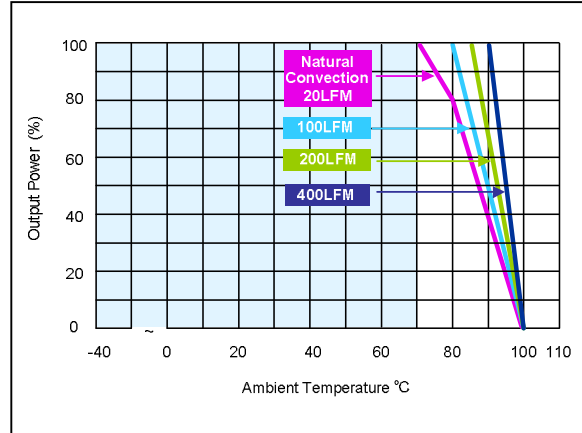

Figure 138: AXA00AA36-L Derating Curves (with heatsink)  
 Vin = 48Vdc Load: Io = 0 to ±1 A

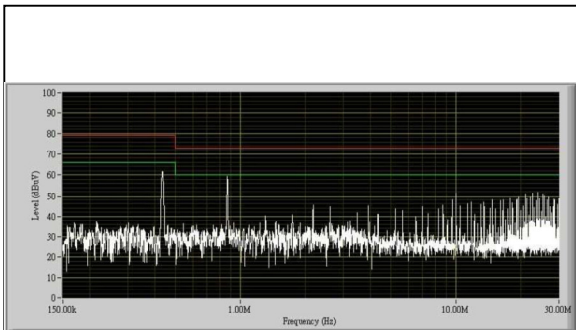

Figure 139: AXA00AA36-L Conduction Emission of EN550122 Class A  
 Vin = 48Vdc Load: Io = ±1 A

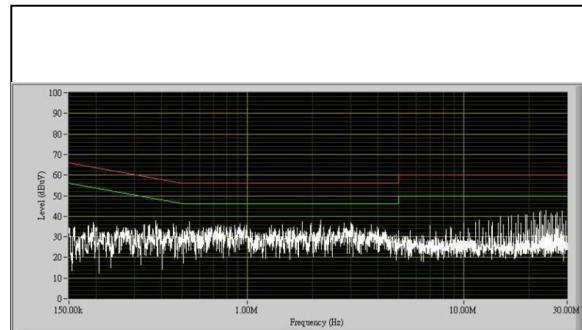

Figure 140: AXA00AA36-L Conduction Emission of EN550122 Class B  
 Vin = 48Vdc Load: Io = ±1 A

Note - All test conditions are at 25 °C

## AXA000BB36-L Performance Curves

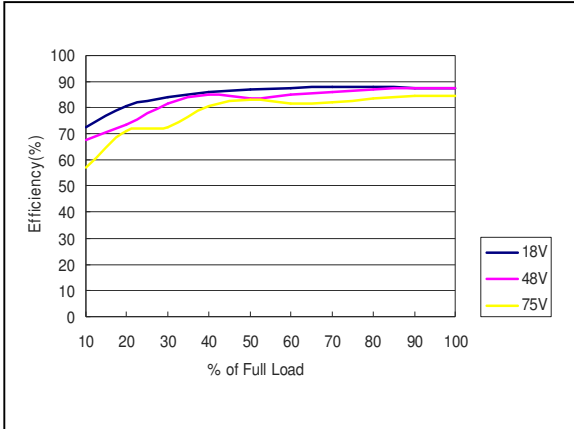

Figure 141: AXA000BB36-L Efficiency Versus Output Current Curve  
 Vin = 18 to 75Vdc Load: Io = 0 to ±0.41 A

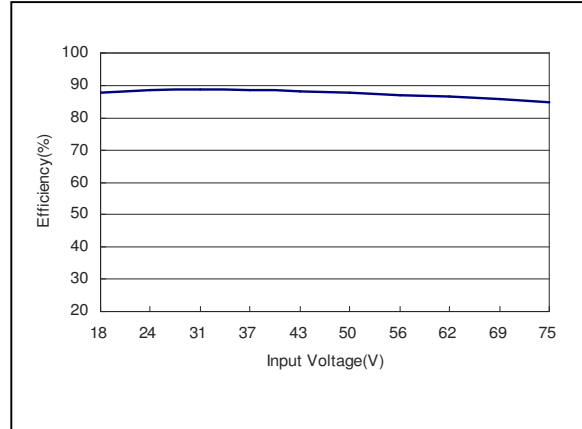

Figure 142: AXA000BB36-L Efficiency Versus Input Voltage Curve  
 Vin = 18 to 75Vdc Load: Io = ±0.41 A

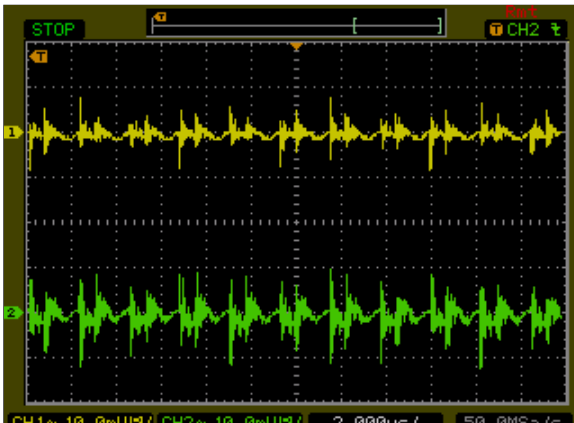

Figure 143: AXA000BB36-L Ripple and Noise Measurement  
 Vin = 48Vdc Load: Io = ±0.41A  
 Ch 1: Vo

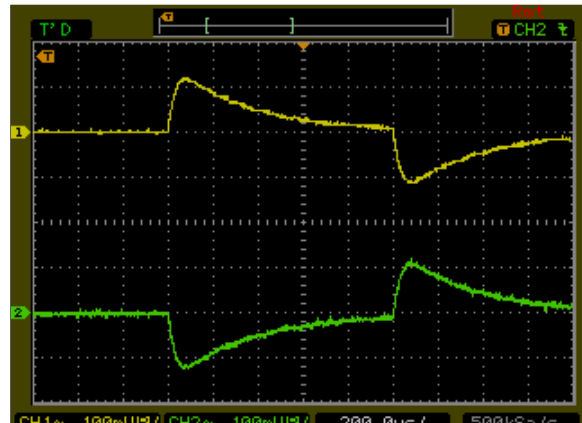

Figure 144: AXA000BB36-L Transient Response  
 Vin = 48Vdc Load: Io = 100% to 75% load change  
 Ch 1: Vo

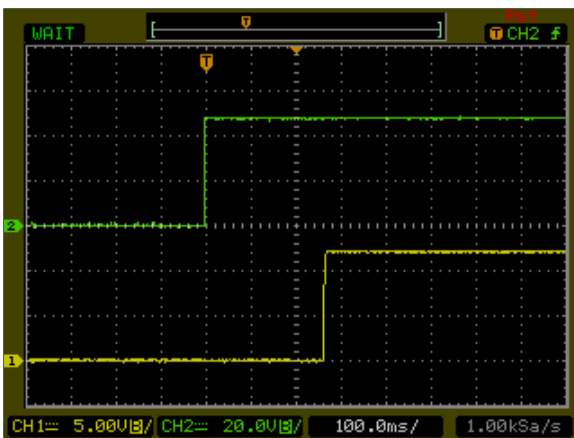

Figure 145: AXA000BB36-L Output Voltage Startup Characteristic by ON/OFF  
 Vin = 48Vdc Load: Io = ±0.41 A  
 Ch1: Vo Ch2: Remote On/Off

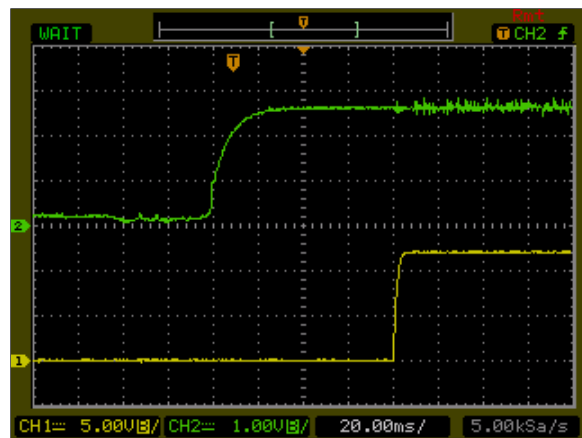

Figure 146: AXA000BB36-L Output Voltage Startup Characteristic by Vin  
 Vin = 48Vdc Load: Io = ±0.41 A  
 Ch1: Vo Ch2: Vin

## AXA000BB36-L Performance Curves

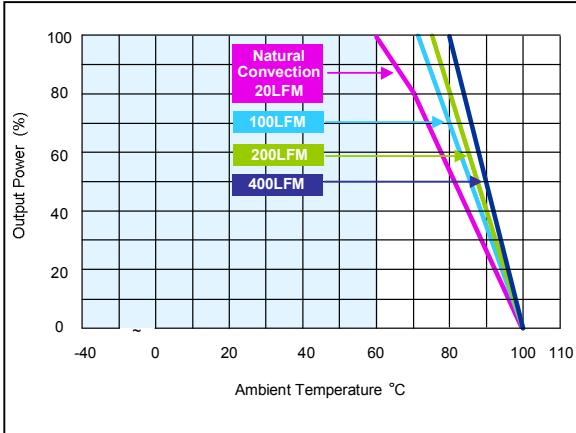

Figure 147: AXA000BB36-L Derating Curves (without heatsink)  
 Vin = 48Vdc Load: Io = 0 to ±0.41 A

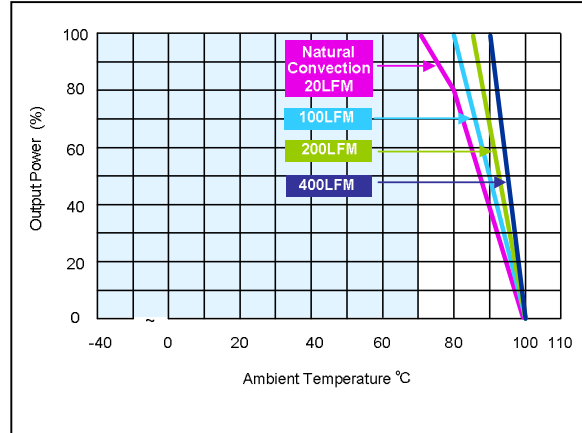

Figure 148: AXA000BB36-L Derating Curves (with heatsink)  
 Vin = 48Vdc Load: Io = 0 to ±0.41 A

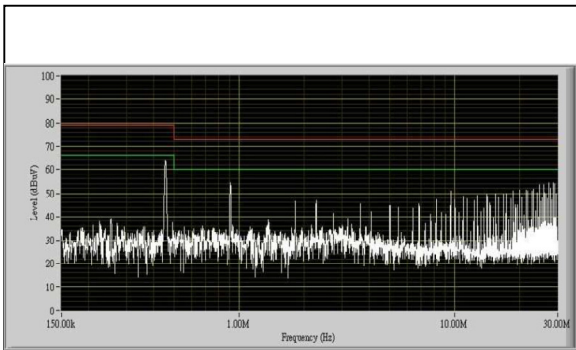

Figure 149: AXA000BB36-L Conduction Emission of EN550122 Class A  
 Vin = 48Vdc Load: Io = ±0.41 A

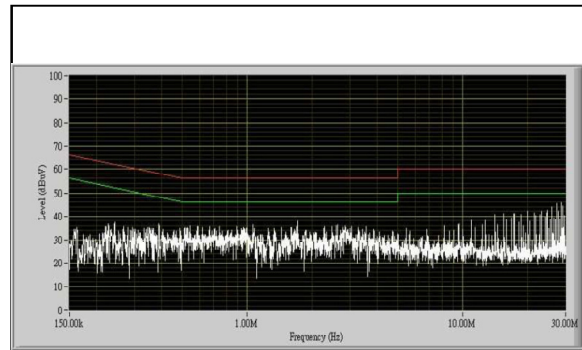

Figure 150: AXA000BB36-L Conduction Emission of EN550122 Class B  
 Vin = 48Vdc Load: Io = ±0.41 A

Note - All test conditions are at 25 °C



## AXA000CC36-L Performance Curves

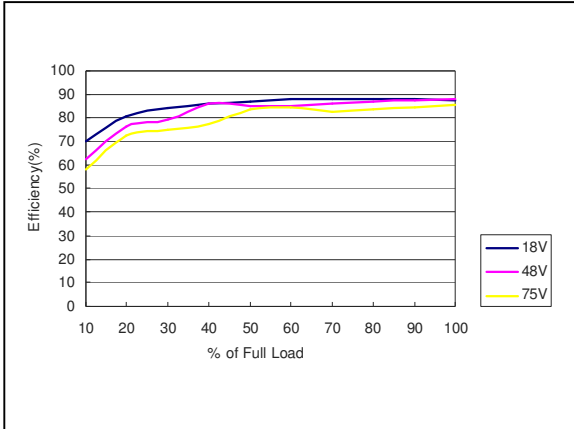

Figure 151: AXA000CC36-L Efficiency Versus Output Current Curve  
 Vin = 18 to 75Vdc Load: Io = 0 to ±0.33 A

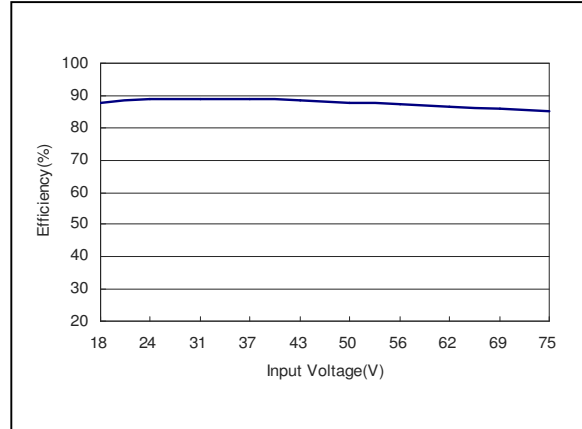

Figure 152: AXA000CC36-L Efficiency Versus Input Voltage Curve  
 Vin = 18 to 75Vdc Load: Io = ±0.33 A

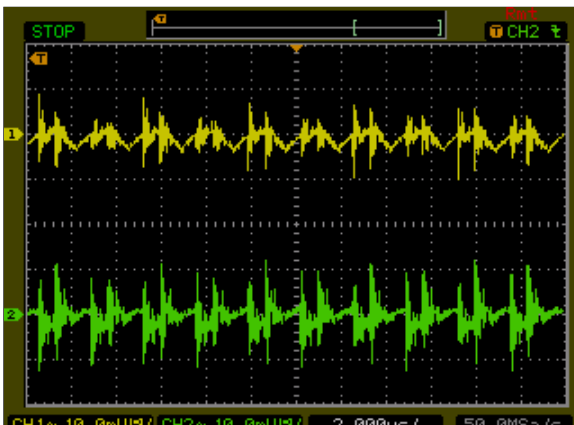

Figure 153: AXA000CC36-L Ripple and Noise Measurement  
 Vin = 48Vdc Load: Io = ±0.33A  
 Ch 1: Vo

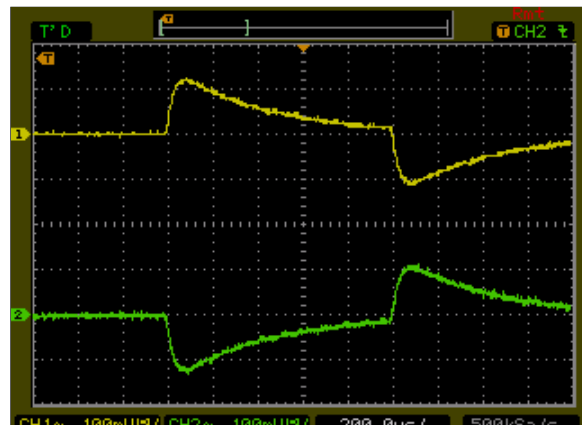

Figure 154: AXA000CC36-L Transient Response  
 Vin = 48Vdc Load: Io = 100% to 75% load change  
 Ch 1: Vo

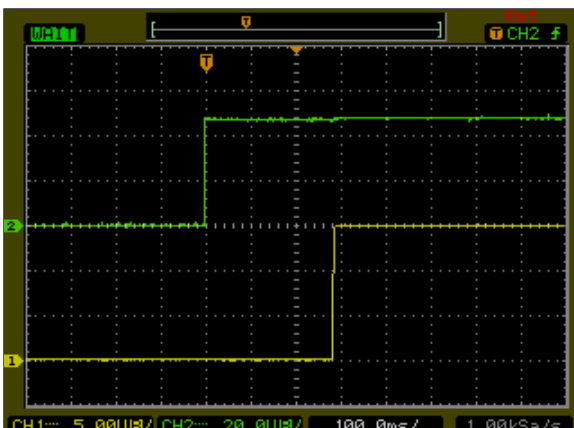

Figure 155: AXA000CC36-L Output Voltage Startup Characteristic by ON/OFF  
 Vin = 48Vdc Load: Io = ±0.33 A  
 Ch1: Vo Ch2: Remote On/Off

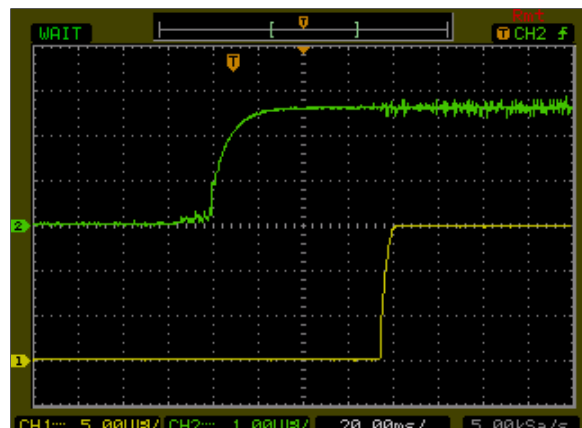

Figure 156: AXA000CC36-L Output Voltage Startup Characteristic by Vin  
 Vin = 48Vdc Load: Io = ±0.33A  
 Ch1: Vo Ch2: Vin

## AXA000CC36-L Performance Curves

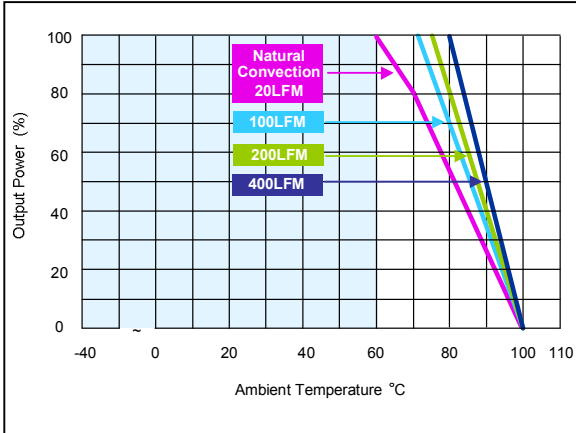

Figure 157: AXA000CC36-L Derating Curves (without heatsink)  
 Vin = 48Vdc Load: Io = 0 to ±0.33 A

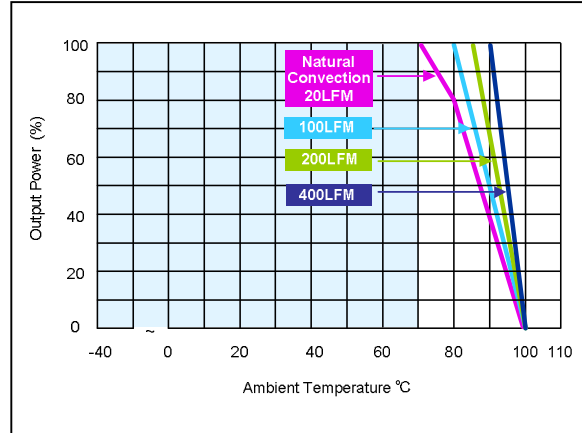

Figure 158: AXA000CC36-L Derating Curves (with heatsink)  
 Vin = 48Vdc Load: Io = 0 to ±0.33 A

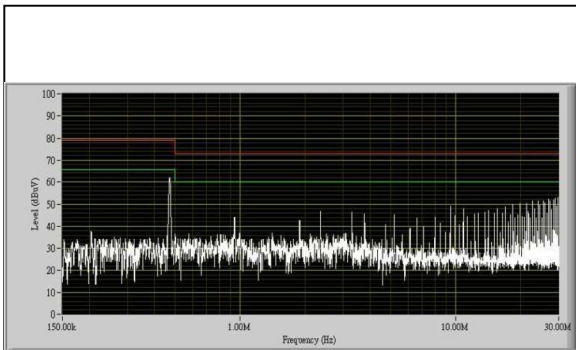

Figure 159: AXA000CC36-L Conduction Emission of EN550122 Class A  
 Vin = 48Vdc Load: Io = ±0.33 A

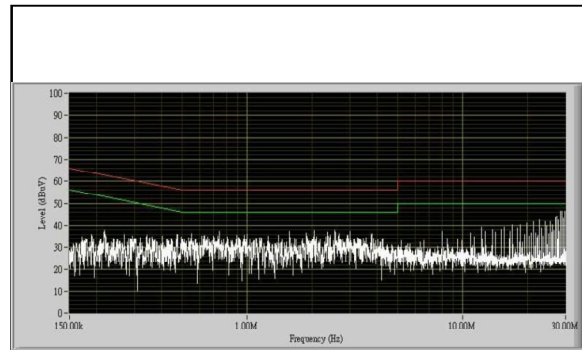
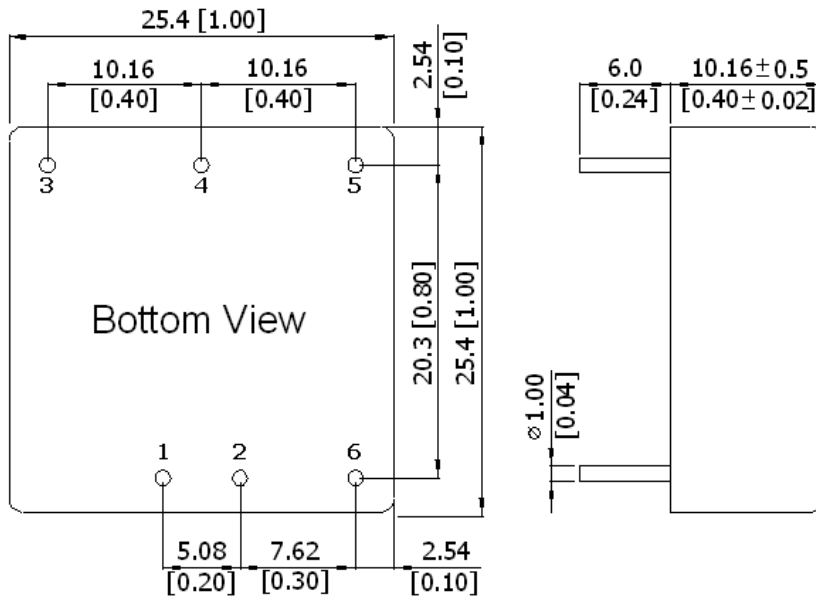

Figure 160: AXA000CC36-L Conduction Emission of EN550122 Class B  
 Vin = 48Vdc Load: Io = ±0.33 A

Note - All test conditions are at 25 °C

## Mechanical Specifications

### Mechanical Outlines



**Note:**

1. All dimensions in mm (inches)
- Tolerance: X.X ± 0.25 (X.XX ± 0.01)  
 X.XX ± 0.13 (X.XXX ± 0.005)
2. Pin pitch tolerance: ±0.25 (±0.01")
3. Pin diameter 1.0 ± 0.05 (0.04 ± 0.002)

### Pin Connections

#### Single output

- Pin 1 – +Vin
- Pin 2 – -Vin
- Pin 3 – +Vout
- Pin 4 – No Pin
- Pin 5 – -Vout
- Pin 6 – Remote On/Off

#### Dual Output

- Pin 1 – +Vin
- Pin 2 – -Vin
- Pin 3 – +Vout
- Pin 4 – Common
- Pin 5 – -Vout
- Pin 6 – Remote On/Off

### Physical Characteristics

Device code suffix	L
Case Size	25.4x25.4x10.16mm (1.0x1.0x0.4 inches)
Case Material	Aluminium Alloy, Black Anodized Coating
Base Material	FR4 PCB (flammability to UL 94V-0 rated)
Pin Material	Copper Alloy with Gold Plate Over Nickel Subplate
Weight	15g

**Heatsink (Option -HS)**

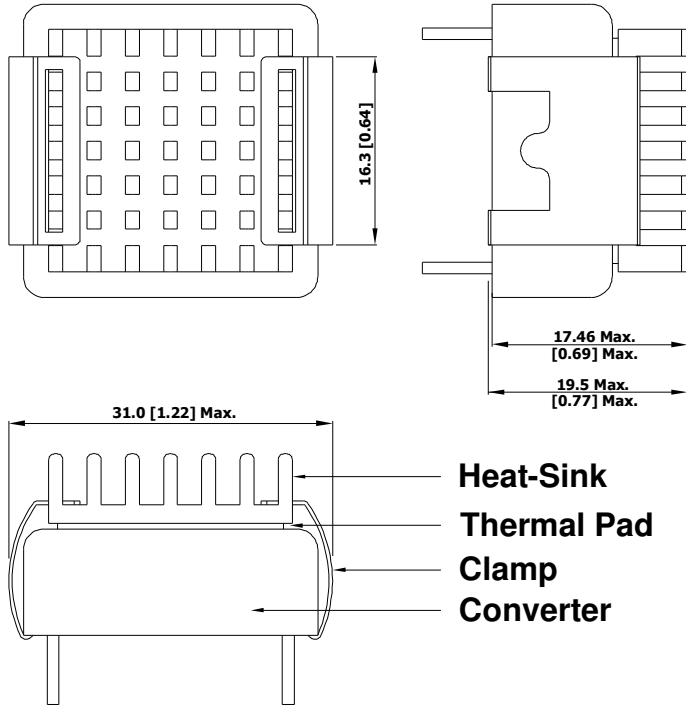

Heatsink Material: Aluminum

Finish: Anodoc treatment (Black)

Weight: 2g

The advantages of adding a heatsink are:

1. To improve heat dissipation and increase the stability and reliability of the DC/DC converters at high operating temperatures.
2. To increase operating temperature of the DC/DC converter, please refer to derating curve.

**Recommended Pad Layout for Single & Dual Output Converter**

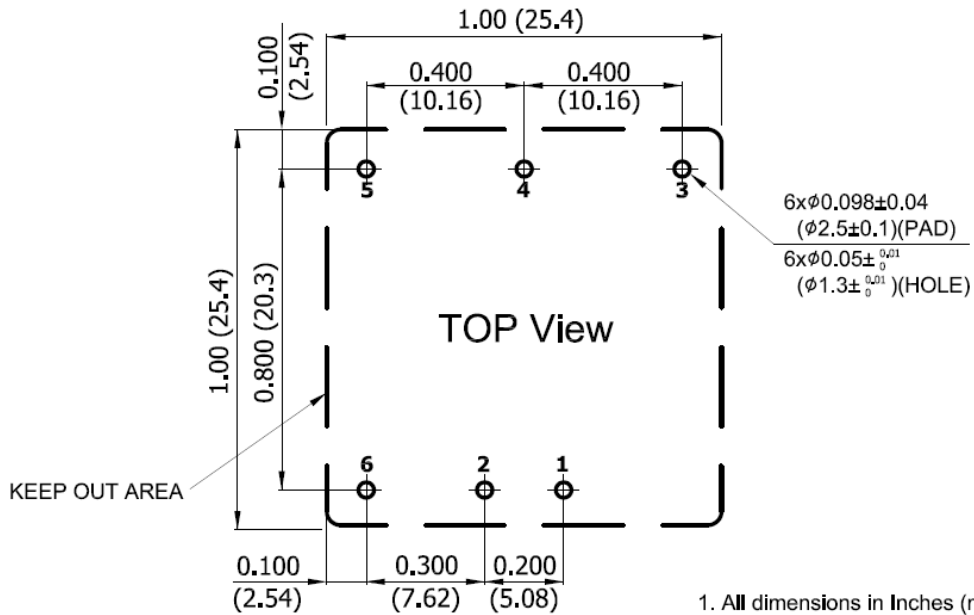

1. All dimensions in Inches (mm)  
 Tolerance: X.XX±0.02" (X.X±0.5)  
 X.XXX±0.01" (X.XX±0.25mm)
2. Pin pitch tolerance:±0.01" (±0.25mm)
3. Pin dimension tolerance:±0.004" (±0.1mm)

## EMC Considerations

EMI-Filter to meet EN 55022, class B, FCC part 15, level

Conducted and radiated emissions EN55022 Class B

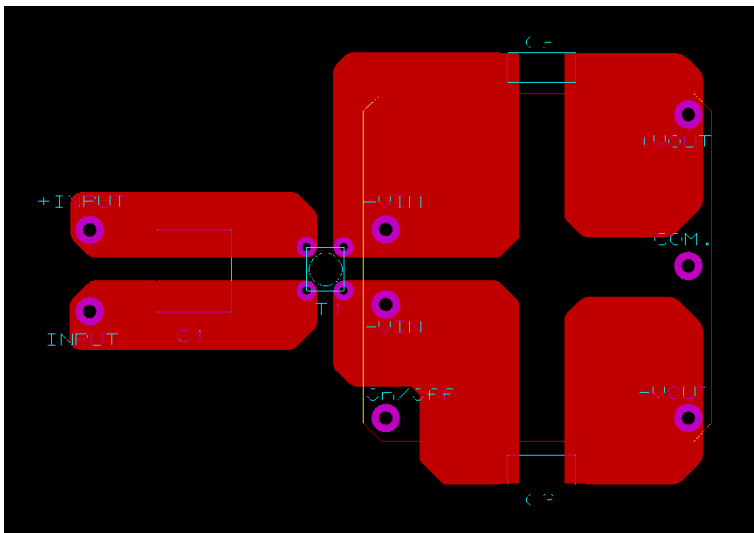
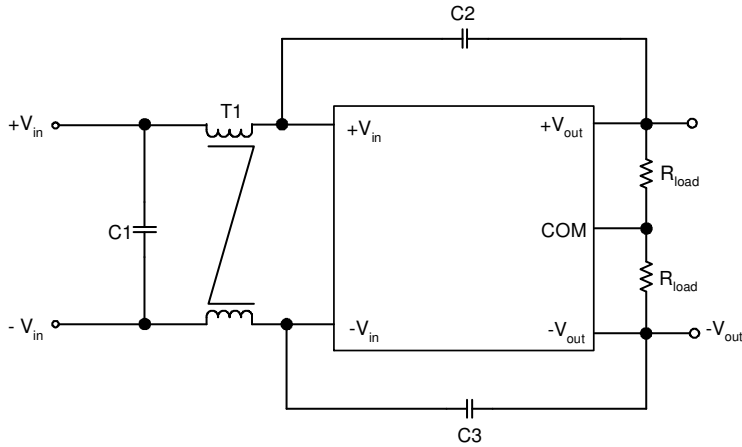

Table 4. Conducted EMI emission specifications

Model	Component	Value
AXAXX18-L	C1	4.7 $\mu$ F/50V 1210 X7R
	C2	470pF/2KV 1808 X7R
	T1	3.3mH ; Wurth Elektronik NO.744822233
AXAXX36-L	C1	2.2 $\mu$ F/100V 1210 X7R
	C2	680pF/2KV 1808 X7R
	T1	3.3mH ; Wurth Elektronik NO.744822233

## **Safety Certifications**

The AXA 10W power supply is intended for inclusion in other equipment and the installer must ensure that it is in compliance with all the requirements of the end application. This product is only for inclusion by professional installers within other equipment and must not be operated as a stand alone product.

Table 5. Safety Certifications for AXA series power supply system

<b>Document</b>	<b>Description</b>
cUL/UL 60950-1 (CSA certificate)	US and Canada Requirements
IEC/EN 60950-1 (CB-scheme)	European Requirements



## MTBF and Reliability

The MTBF of AXA10W series of DC/DC converters has been calculated using MIL-HDBK 217F NOTICE2, Operating Temperature 25 °C, Ground Benign.

Model	MTBF	Unit
AXA02F18-L	848104	Hours
AXA02A18-L	849907	
AXA00B18-L	922254	
AXA00C18-L	926012	
AXA000H18-L	976849	
AXA00AA18-L	803665	
AXA000BB18-L	812942	
AXA000CC18-L	839983	
AXA02F36-L	874508	
AXA02A36-L	847529	
AXA00B36-L	924044	
AXA00C36-L	927816	
AXA000H36-L	985999	
AXA00AA36-L	791139	
AXA000BB36-L	832362	
AXA000CC36-L	832362	

## Application Notes

### Input Reflected-Ripple Current Test Setup

Input reflected-ripple current is measured with an inductor  $L_{in}$  ( $4.7\mu H$ ) and  $C_{in}$  ( $220\mu F$ ,  $ESR < 1.0\Omega$  at  $100\text{ KHz}$ ) to simulate source impedance. Capacitor  $C_{in}$ , offsets possible battery impedance. Current ripple is measured at the input terminals of the module, measurement bandwidth is  $0\text{-}500\text{ KHz}$ .

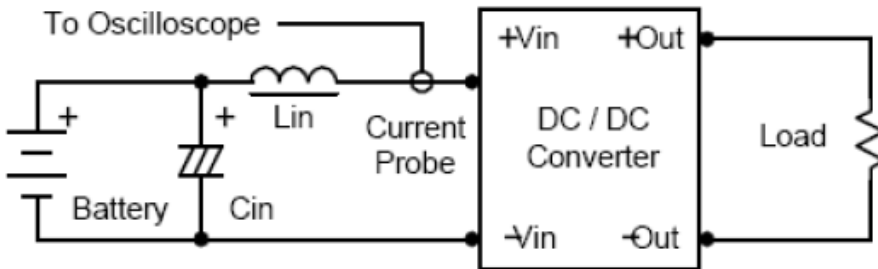

Component	Value	Reference
$L_{in}$	$4.7\mu H$	-
$C_{in}$	$220\mu F$ ( $ESR < 1.0\Omega$ at $100\text{ KHz}$ )	Aluminum Electrolytic Capacitor

## Output Ripple Reduction

A good quality low ESR capacitor placed as close as practicable across the load will give the best ripple and noise performance. To reduce output ripple, it is recommended to use 4.7uF capacitors at the output.

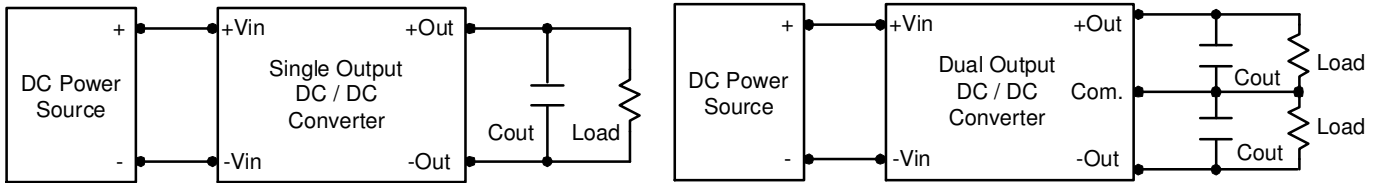

## Peak-to-Peak Output Noise Measurement Test

Use a 1uF ceramic capacitor and a 10uF tantalum capacitor. Scope measurement should be made by using a BNC socket, measurement bandwidth is 0-20MHz. Position the load between 50 mm and 75 mm from the DC/DC Converter

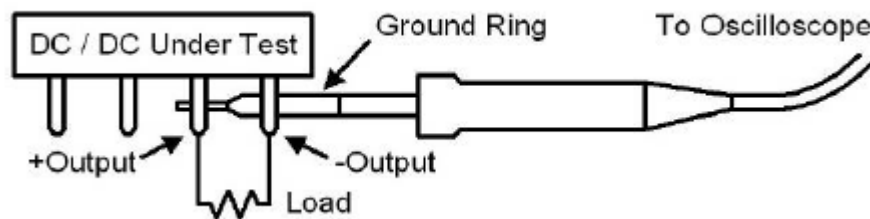
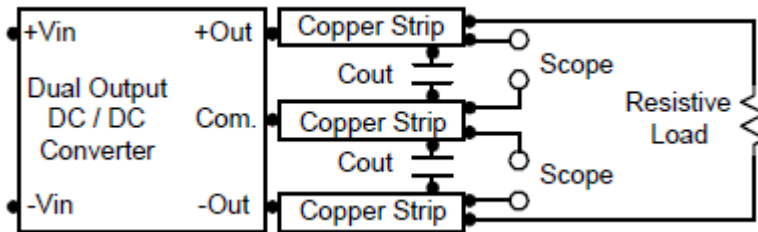
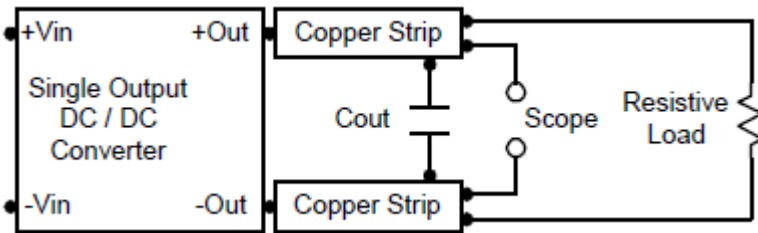

## Remote ON/OFF

Positive logic remote on/off turns the module on during a logic high voltage on the remote on/off pin, and off during a logic low. To turn the power module on and off, the user must supply a switch to control the voltage between the on/off terminal and the -Vin terminal. The switch can be an open collector or equivalent. A logic low is 0V to 1V. A logic high is 2.5V to 50V. The maximum sink current at the on/off terminal (Pin 6) during a logic low is -500 $\mu$ A. The maximum allowable leakage current of a switch connected to the on/off terminal (Pin 6) at logic high (3.5V to 12V) is 10mA.

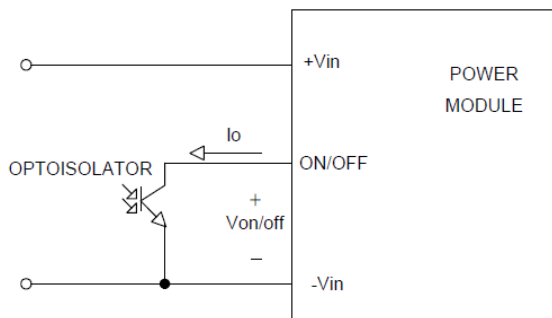

Isolated-Closure Remote ON/OFF

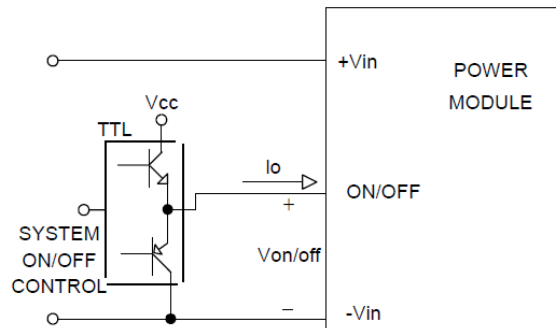

Level Control Using TTL Output

## Overcurrent Protection

The AXA10W series converters contain hiccup mode output over current protection that prevents damage to the product in the event of an overload or a short circuit. Normally, over current is maintained at approximately 150 percent of rated current for AXA10W series. Depending upon the converter design, there are other ways of protecting the converter against over current conditions such as the constant current limiting or current foldback methods. With “hiccup” over current protection, the converter shuts off upon an occurrence of an over current condition. After a brief time interval, it automatically tries to restart the converter. If the restart is successful, normal operation continues. If the over current condition still exists, the converter will shut off again. With a sustained over current condition, such as a short circuit on the output, this automatic retry behavior will result in periodic pulses of current and voltage on the output. The output current waveform with hiccup over current protection is shown in figure below.

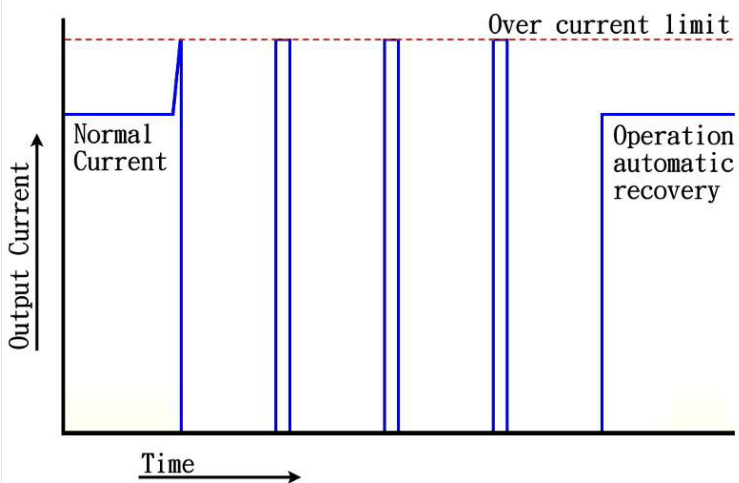

Hiccup operation has none of the drawbacks of the other two protection methods, although its circuit is more complicated because it requires a timing circuit. The excess heat due to overload lasts for only a short duration in the hiccup cycle, hence the junction temperature of the power devices is much lower. The hiccup operation can be done in various ways. For example, one can start hiccup operation any time once an over-current event is detected; or prohibit hiccup during a designated start-up interval (usually a few milliseconds). The reason for the latter operation is that during start-up, the converter needs to provide extra current to charge up the output capacitor. Thus the current demand during start-up is usually larger than during normal operation and it is easier for an over-current event to occur. If the converter starts to hiccup once there is an over-current, it might never start up successfully. Hiccup mode protection will give the best protection for a converter against over current situations, since it will limit the average current to the load at a low level, so reducing power dissipation and case temperature in the power devices..

## Short Circuitry Protection

Continuous, hiccup and auto-recovery mode.

During short circuit, converter still shut down, The average current during this condition will be very low and the device will be safe in this condition.

## Input Source Impedance

The power module should be connected to a low ac-impedance input source. Highly inductive source impedances can affect the stability of the power module.

In applications where power is supplied over long lines and output loading is high, it may be necessary to use a capacitor at the input to ensure startup.

Capacitor mounted close to the power module helps ensure stability of the unit, it is recommended to use a good quality low Equivalent Series Resistance ( $ESR < 1.0\Omega$  at 100 KHz) capacitor of a  $10\mu F$  for the 24V and 48V devices

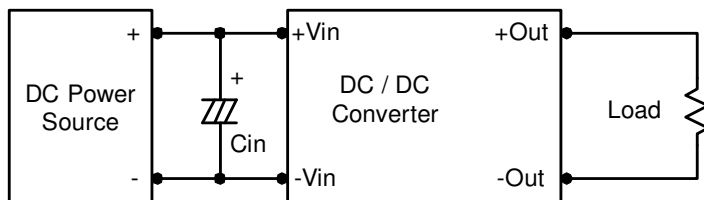

## **Thermal Considerations**

Many conditions affect the thermal performance of the power module, such as orientation, airflow over the module and board spacing. To avoid exceeding the maximum temperature rating of the components inside the power module, the case temperature must be kept below 105°C. The derating curves are determined from measurements obtained in a test setup.

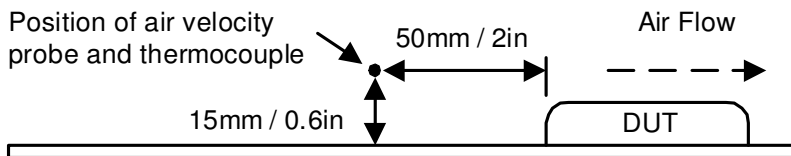

## **Maximum Capacitive Load**

The AXA10W series has limitation of maximum connected capacitance at the output. The power module may be operated in current limiting mode during start-up, affecting the ramp-up and the startup time. The maximum capacitance can be found in the data sheet.



**Packaging Information**

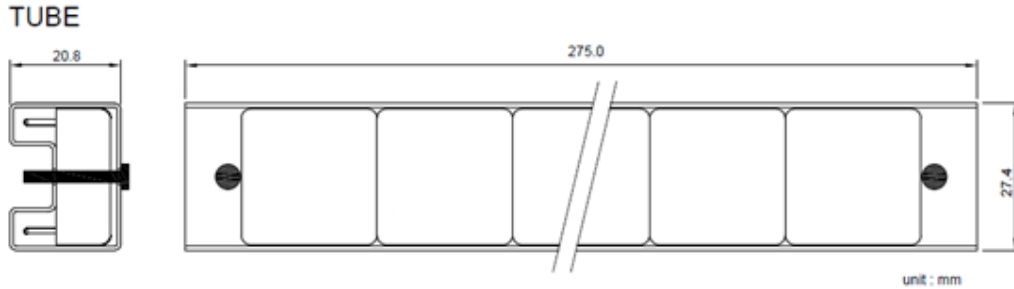

10 PCS per TUBE

**Soldering and Reflow Considerations**

Lead free wave solder profile for AXA10W Series

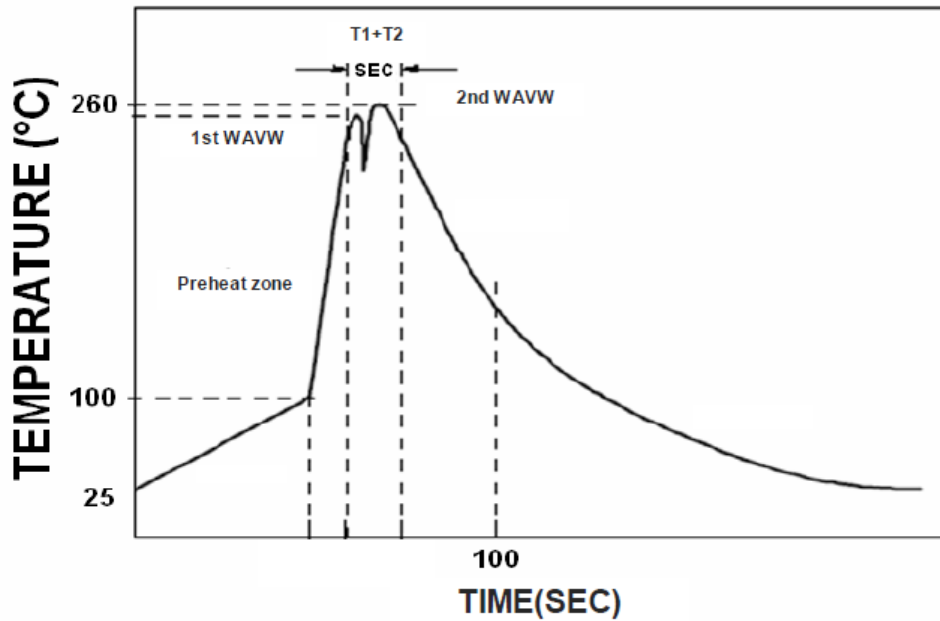

Zone	Reference Parameter
Preheat zone	Rise temp speed : 3°C/sec max.
	Preheat temp : 100~130°C
Actual heating	Peak temp: 250~260°C Peak Time
	Peak time(T1+T2): 4~6 sec

Reference Solder: Sn-Ag-Cu : Sn-Cu : Sn-Ag  
 Hand Welding: Soldering iron : Power 60W  
 Welding Time: 2~4 sec  
 Temp.: 380~400 °C

## Weight

The AXA10W series weight is 15g maximum.

### WORLDWIDE OFFICES

#### Americas

2900 S.Diablo Way  
Tempe, AZ 85282  
USA  
+1 888 412 7832

#### Europe (UK)

Waterfront Business Park  
Merry Hill, Dudley  
West Midlands, DY5 1LX  
United Kingdom  
+44 (0) 1384 842 211

#### Asia (HK)

14/F, Lu Plaza  
2 Wing Yip Street  
Kwun Tong, Kowloon  
Hong Kong  
+852 2176 3333



[www.artesyn.com](http://www.artesyn.com)

While every precaution has been taken to ensure accuracy and completeness in this literature, Artesyn Embedded Technologies assumes no responsibility, and disclaims all liability for damages resulting from use of this information or for any errors or omissions. Artesyn Embedded Technologies, Artesyn and the Artesyn Embedded Technologies logo are trademarks and service marks of Artesyn Technologies, Inc. All other names and logos referred to are trade names, trademarks, or registered trademarks of their respective owners.  
© 2014 All rights reserved.

For more information: [www.artesyn.com/power](http://www.artesyn.com/power)  
For support: [productsupport.ep@artesyn.com](mailto:productsupport.ep@artesyn.com)