

PQ2CF1

TO-220 Package, Step Up Output Chopper Regulator

Features

- Maximum switching current:2.5A
- Built-in soft start function
- Built-in oscillation circuit
(oscillation frequency:TYP.50kHz)
- Built-in overheat protection,overcurrent protection function
- Variable output voltage(4.5 to 35V)
[Possible to choose step up output / flyback method according to external connection circuit]

Applications

- Personal computers / Word processors
- Printers
- Switching power supplies
- Facsimiles

Outline Dimensions

(Unit : mm)

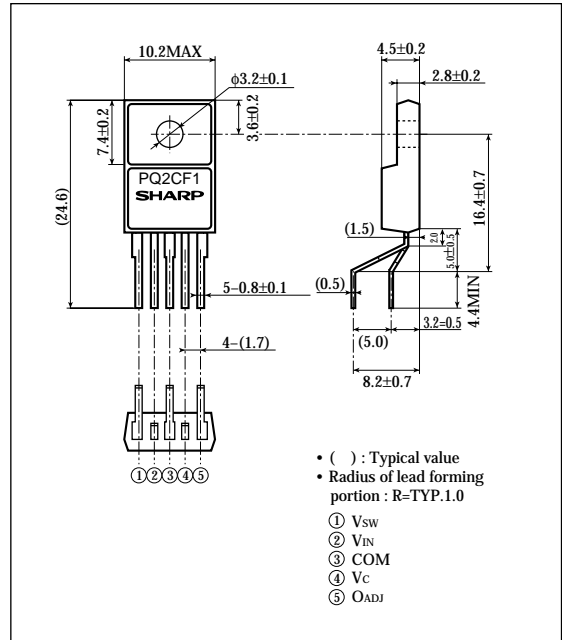

Absolute Maximum Ratings

(T_a=25°C)

Parameter	Symbol	Rating	Unit
*1 Input voltage	V _{IN}	35	V
*2 Switching voltage	V _{SW}	35	V
Error input voltage	V _{ADJ}	7	V
*3 ON/OFF control voltage	V _C	7	V
Switching current	I _{SW}	2.5	A
Power dissipation (No heat sink)	P _{D1}	1.5	W
Power dissipation (With infinite heat sink)	P _{D2}	15	W
*4 Junction temperature	T _J	150	°C
Operating temperature	T _{opr}	-20 to +80	°C
Storage temperature	T _{stg}	-40 to +150	°C
Soldering temperature	T _{sol}	260 (For 10s)	°C

- *1 Voltage between V_{IN} terminal and COM terminal
 *2 Voltage between V_{SW} terminal and COM terminal
 *3 Voltage between V_C terminal and COM terminal
 *4 Overheat protection may operate at 125<=T_J<=150°C.

• Please refer to the chapter " Handling Precautions ".

SHARP

Electrical Characteristics

(Unless otherwise specified, conditions shall be $V_{IN}=5V, I_O=0.2A, V_C=12V, T_a=25^{\circ}C$)

Parameter	Symbol	Conditions	MIN.	TYP.	MAX.	Unit
Output saturation voltage	V_{SAT}	$I_{SW}=2A$	—	0.6	1.2	V
Reference voltage	V_{ref}	—	1.235	1.26	1.285	V
Reference voltage temperature fluctuation	ΔV_{ref}	$T_j=0$ to $125^{\circ}C$	—	± 0.5	—	%
Load regulation	R_{egL}	$I_O=70$ to $570mA$	—	0.1	1.5	%
Line regulation	R_{egI}	$V_{IN}=3.5$ to $10V$	—	0.2	1.5	%
Efficiency	η	$I_O=0.5A$	—	85	—	%
Oscillation frequency	f_o	—	40	50	60	kHz
Oscillation frequency temperature fluctuation	Δf_o	$T_j=0$ to $125^{\circ}C$	—	± 5	—	%
Maximum duty	D_{MAX}	⑤ terminal is open	90	—	—	%
Over current detecting level	I_L	Duty=50%,	2.7	4.4	5.8	A
Charge current 1	I_{CHG1}	④ terminal=0V, ④ terminal	-80	-50	-20	μA
Charge current 2	I_{CHG2}	④ terminal=0.5V, ④ terminal	-150	-100	-50	μA
Input threshold voltage	V_{THL}	Duty=0%, ④ terminal	0.55	0.75	0.95	V
Vc terminal low level voltage	V_{CH}	① terminal is open, ⑤ terminal=1.1V	1.65	1.85	2.05	V
Vc terminal high level voltage	V_{CL}	① terminal is open, ⑤ terminal=1.4V	0.3	0.45	0.6	V
On threshold voltage	V_{THON}	① terminal is open, ④ terminal	0.1	0.2	0.3	V
Stand-by current	I_{SD}	$V_{IN}=35V$, ④ terminal=0V, No L, Co, D, R1, R2	—	270	400	μA
Output OFF-state consumption current	I_{QS}	$V_{IN}=35V$, ④ terminal=0.5V, No L, Co, D, R1, R2	—	4.0	12	mA

Block Diagram

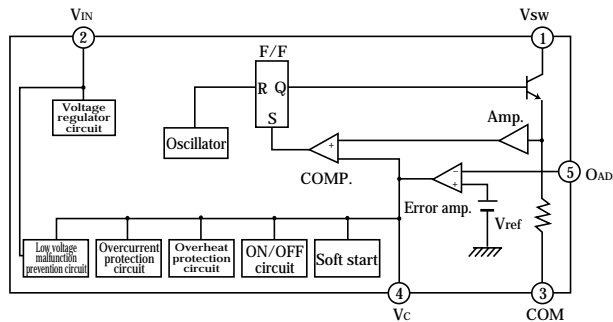
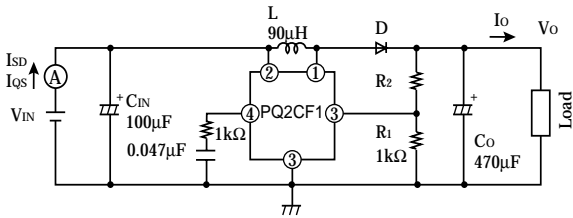
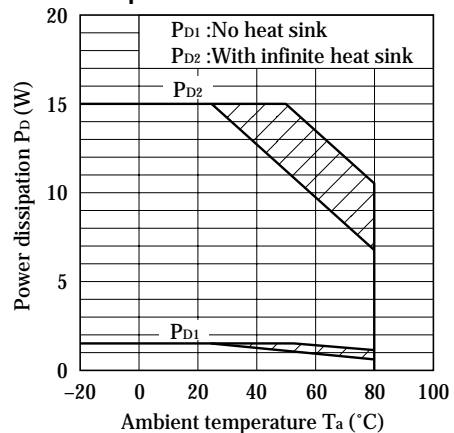

Fig. 1 Test Circuit



L : HK-12S100-9000 (made by Toho Co.)
 D : ERC80-004 (made by Fuji electronics Co.)

Fig. 2 Power Dissipation vs. Ambient Temperature



Note) Oblique line portion : Overheat protection may operate in this area.

Fig. 3 Overcurrent Protection Characteristics

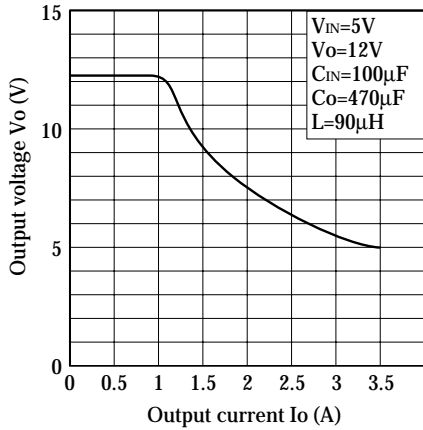

Fig. 4 Efficiency vs. Input Voltage

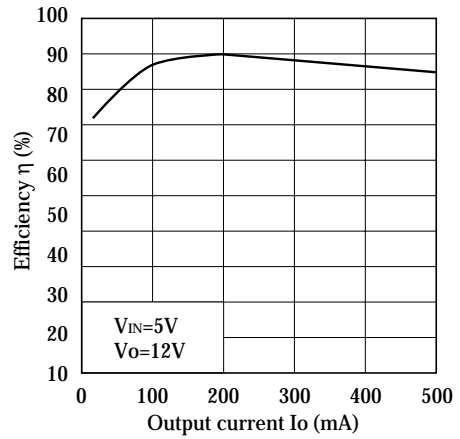

Fig. 5 Reference Voltage Fluctuation vs. Junction Temperature

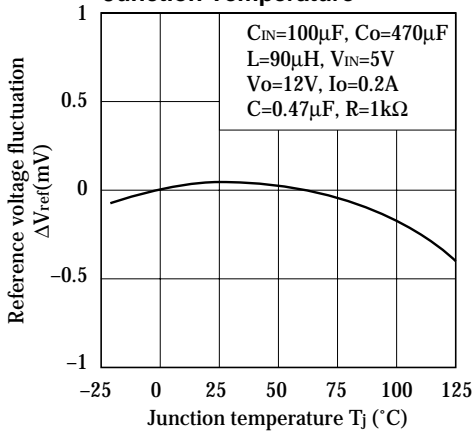

Fig. 6 Load Regulation vs. Output current

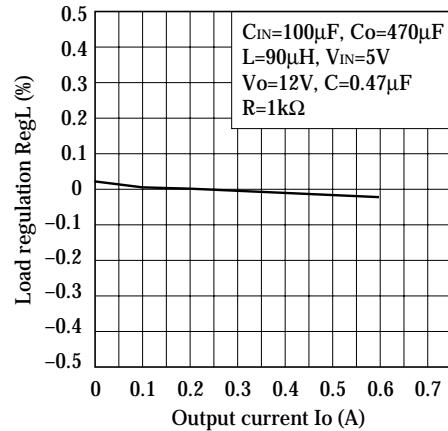

Fig. 7 Line Regulation vs. Input Voltage

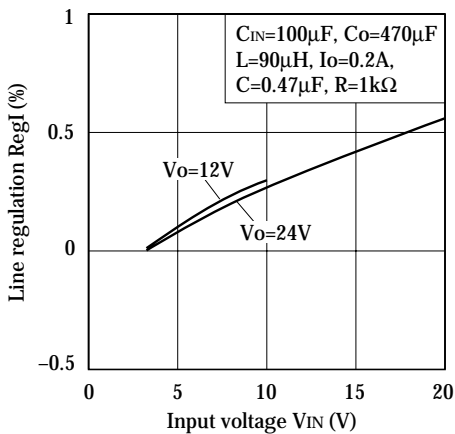

Fig. 8 Oscillation Frequency Fluctuation vs. Junction Temperature

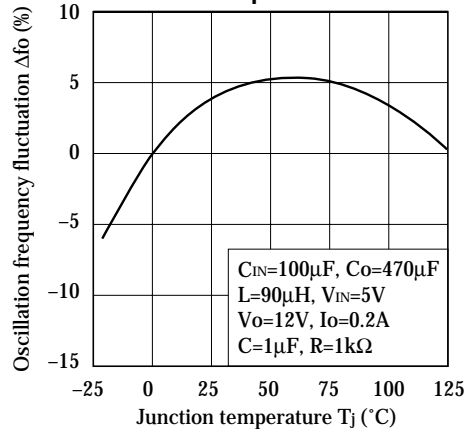
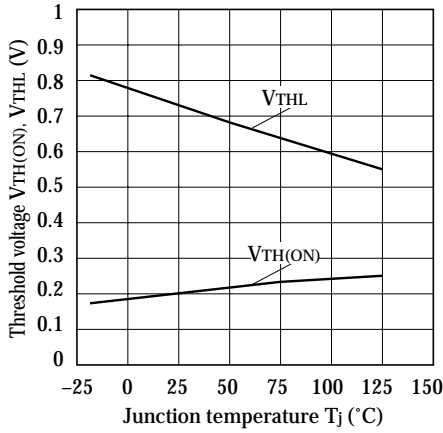
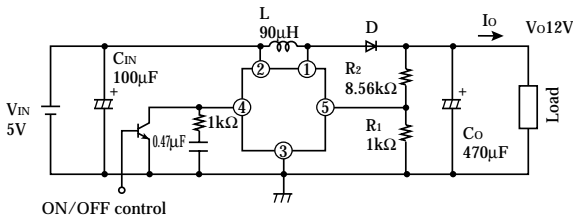

Fig. 9 Threshold Voltage vs. Junction Temperature



■ Step - Up Type Circuit Diagram (12V Output)



■ Flyback Method Circuit Diagram

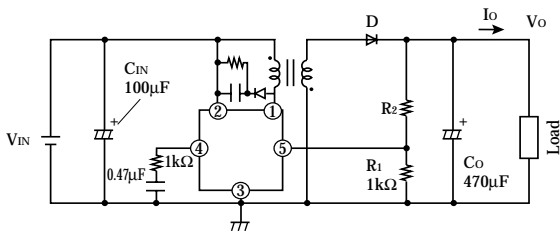

NOTICE

- The circuit application examples in this publication are provided to explain representative applications of SHARP devices and are not intended to guarantee any circuit design or license any intellectual property rights. SHARP takes no responsibility for any problems related to any intellectual property right of a third party resulting from the use of SHARP's devices.
- Contact SHARP in order to obtain the latest device specification sheets before using any SHARP device. SHARP reserves the right to make changes in the specifications, characteristics, data, materials, structure, and other contents described herein at any time without notice in order to improve design or reliability. Manufacturing locations are also subject to change without notice.
- Observe the following points when using any devices in this publication. SHARP takes no responsibility for damage caused by improper use of the devices which does not meet the conditions and absolute maximum ratings to be used specified in the relevant specification sheet nor meet the following conditions:
 - (i) The devices in this publication are designed for use in general electronic equipment designs such as:
 - Personal computers
 - Office automation equipment
 - Telecommunication equipment [terminal]
 - Test and measurement equipment
 - Industrial control
 - Audio visual equipment
 - Consumer electronics
 - (ii) Measures such as fail-safe function and redundant design should be taken to ensure reliability and safety when SHARP devices are used for or in connection with equipment that requires higher reliability such as:
 - Transportation control and safety equipment (i.e., aircraft, trains, automobiles, etc.)
 - Traffic signals
 - Gas leakage sensor breakers
 - Alarm equipment
 - Various safety devices, etc.
 - (iii) SHARP devices shall not be used for or in connection with equipment that requires an extremely high level of reliability and safety such as:
 - Space applications
 - Telecommunication equipment [trunk lines]
 - Nuclear power control equipment
 - Medical and other life support equipment (e.g., scuba).
- Contact a SHARP representative in advance when intending to use SHARP devices for any "specific" applications other than those recommended by SHARP or when it is unclear which category mentioned above controls the intended use.
- If the SHARP devices listed in this publication fall within the scope of strategic products described in the Foreign Exchange and Foreign Trade Control Law of Japan, it is necessary to obtain approval to export such SHARP devices.
- This publication is the proprietary product of SHARP and is copyrighted, with all rights reserved. Under the copyright laws, no part of this publication may be reproduced or transmitted in any form or by any means, electronic or mechanical, for any purpose, in whole or in part, without the express written permission of SHARP. Express written permission is also required before any use of this publication may be made by a third party.
- Contact and consult with a SHARP representative if there are any questions about the contents of this publication.