



## ESSENTIAL INFORMATION

BUILD INSTRUCTIONS  
CHECKING YOUR PCB & FAULT-FINDING  
MECHANICAL DETAILS  
HOW THE KIT WORKS

MEASURE INDOOR AND OUTDOOR TEMPERATURES WITH THIS

# THERMOMETER PROJECT KIT

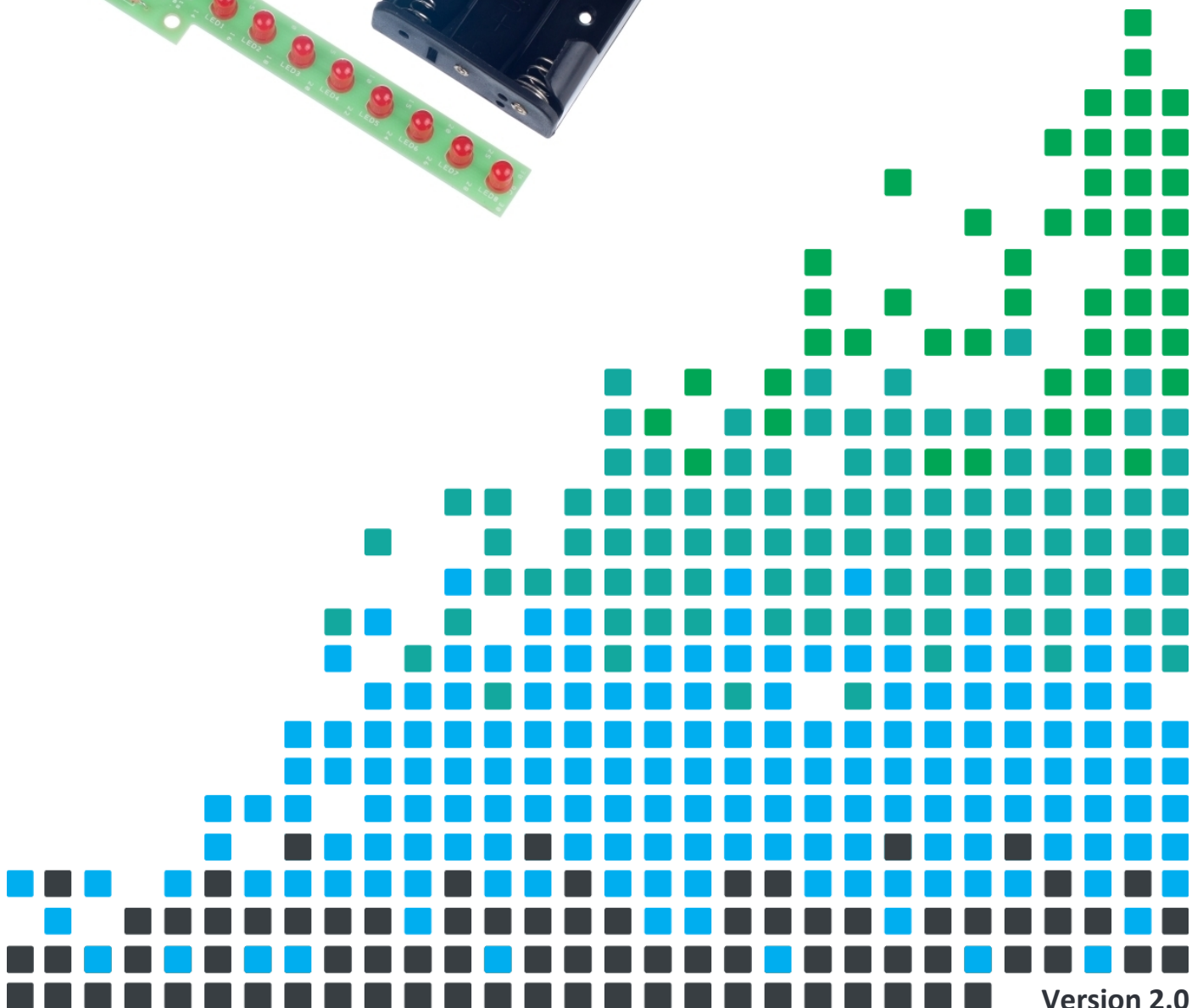
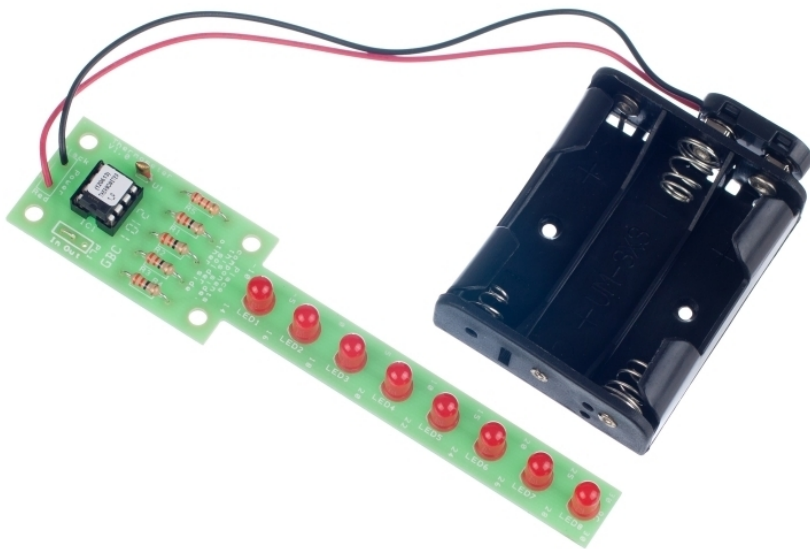

Version 2.0

## Build Instructions

Before you start, take a look at the Printed Circuit Board (PCB). The components go in the side with the writing on and the solder goes on the side with the tracks and silver pads.

### 1 PLACE RESISTORS

Start with the five resistors:  
The text on the PCB shows where R1, R2 etc go.  
Ensure that you put the resistors in the right place.

PCB Ref	Value	Colour Bands
R1, R2, R3 & R4	33Ω	Orange, orange, black
R5	2.2KΩ	Red, red, red



### 2 SOLDER THE THERMISTOR

Solder the thermistor into U1. It does not matter which way around it is inserted.



### 3 SOLDER THE IC HOLDER

Solder the Integrated Circuit (IC) holder into IC1. When putting this into the board, be sure to get it the right way around. The notch on the IC holder should line up with the notch on the lines marked on the PCB.



### 4 SOLDER THE LEDs

Solder the eight Light Emitting Diodes (LEDs) into LED1 – LED8. The LEDs won't work if they don't go in the right way around. If you look carefully one side of the LED has a flat edge, which must line up with the flat edge on the lines on the PCB.



### 5 CONNECT THE WIRES

The thermometer has two temperature scales. One is designed for outdoor use, measuring from -10°C to 30°C. The other is designed for indoor use, measuring from 14°C to 30°C. To select the desired range a wire link (a discarded resistor lead etc.) should be soldered across either the pins labelled 'In' for indoor, or 'Out' for outdoor.

### 6 ATTACH THE BATTERY CLIP

The battery connector should be soldered into the 'Power' terminal. The red wire must go to the '+' terminal and the black wire must go to the '-' terminal.



### 7 INSERT THE IC INTO THE HOLDER

The IC can be put into the holder, ensuring that the notch on the chip lines up with the notch on the holder.



## Checking Your Thermometer PCB

Check the following before you insert the batteries:

### Check the bottom of the board to ensure that:

- All holes (except the 4 large 3mm holes) are filled with the lead of a component.
- All these leads are soldered.
- Pins next to each other are not soldered together.

### Check the top of the board to ensure that:

- The notch on the IC holder / IC is next to the indoor / outdoor selector.
- The flat edge of each of the LEDs matches the outline on the board.
- The colour bands on R5 are red, red, red.
- The power lead is connected the right way around (red to '+', black to '-').

## Testing the PCB

The software on the microcontroller has been specially designed to allow easy testing of the PCB.

On power up, the LEDs flash in turn LED1, LED2, through to LED8 for one second each. It then displays the temperature and continues to do this every ten seconds thereafter. Thirty seconds after power up, a bit of the non-volatile memory is used to log the successful running of the test routine and on subsequent power ups this is not run.

**If your board does not function correctly when tested disconnect the power within 30 seconds of power up, otherwise you will not have the benefit of the test functionality on subsequent power ups.**

If the LEDs do not light in turn, or the temperature is incorrectly displayed, use the fault finding flow charts to work out why.



## Adding an On / Off Switch

You can add either a normally closed or a normally open push button switch, which works as follows:

**Normally closed:** When the button is pressed, it goes open circuit and removes power from the thermometer. When released it causes the software to start again and displays the temperature. In the meantime the temperature is displayed every ten seconds in any case.

**Normally open:** When this button is pressed the thermometer is powered and it displays the temperature. As the temperature is only shown when the button is pressed, the batteries will last considerably longer with this setup.

**Toggle switch:** The thermometer will show the temperature every ten seconds when switched on. Nothing is shown when switched off. *The toggle switch option is shown below.*

If you wish to add a power switch, don't solder both ends of the battery clip directly into the board, instead:

1

Solder one end of the battery clip to the PCB, either black to '-' or red to '+'.

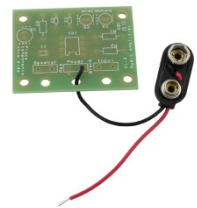

2

Solder the other end of the battery clip to the on / off switch.



3

Using a piece of wire, solder the remaining terminal on the on / off switch to the remaining power connection on the PCB.



## Fault finding flow chart - page 1

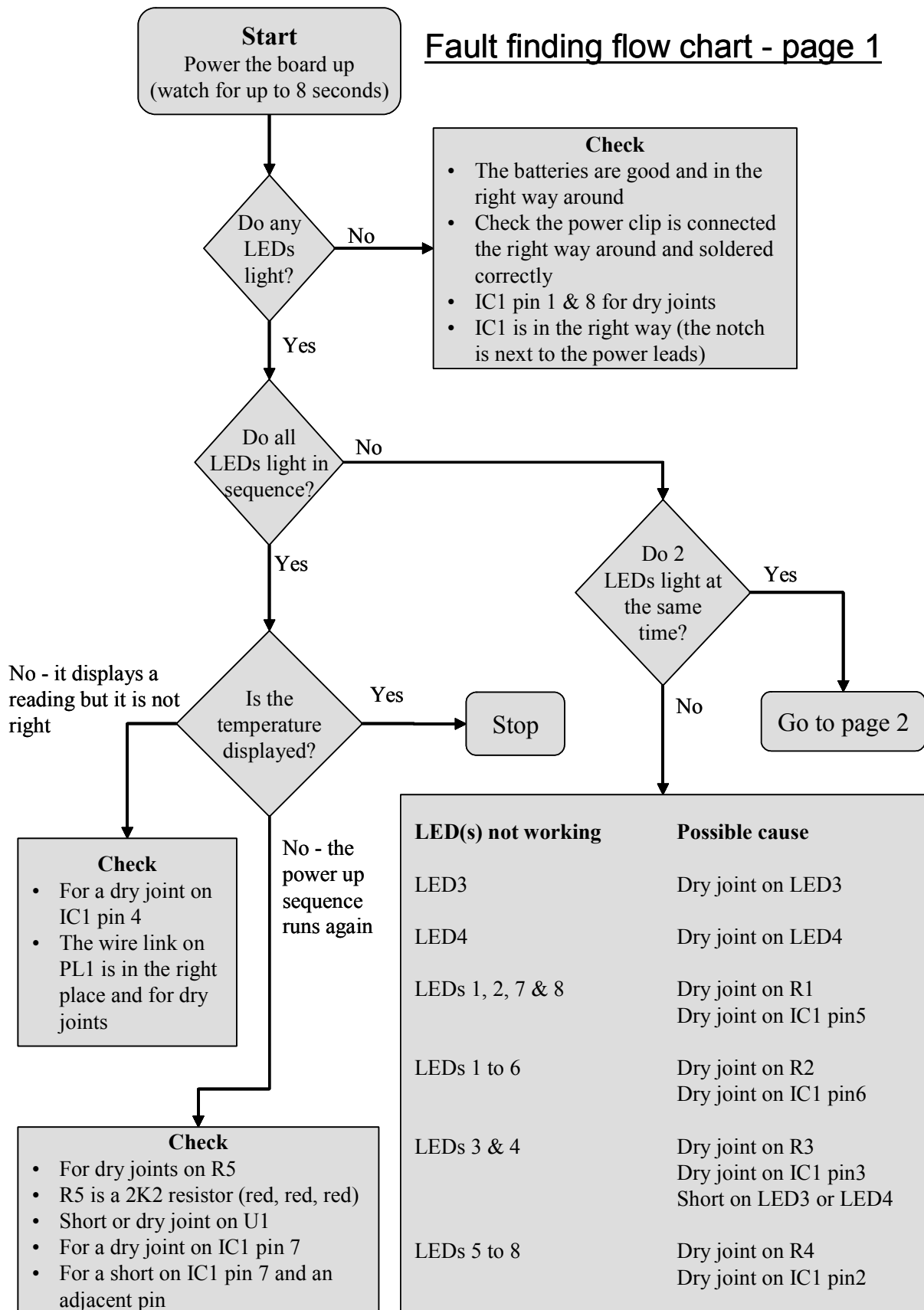

## Fault finding flow chart - Page 2

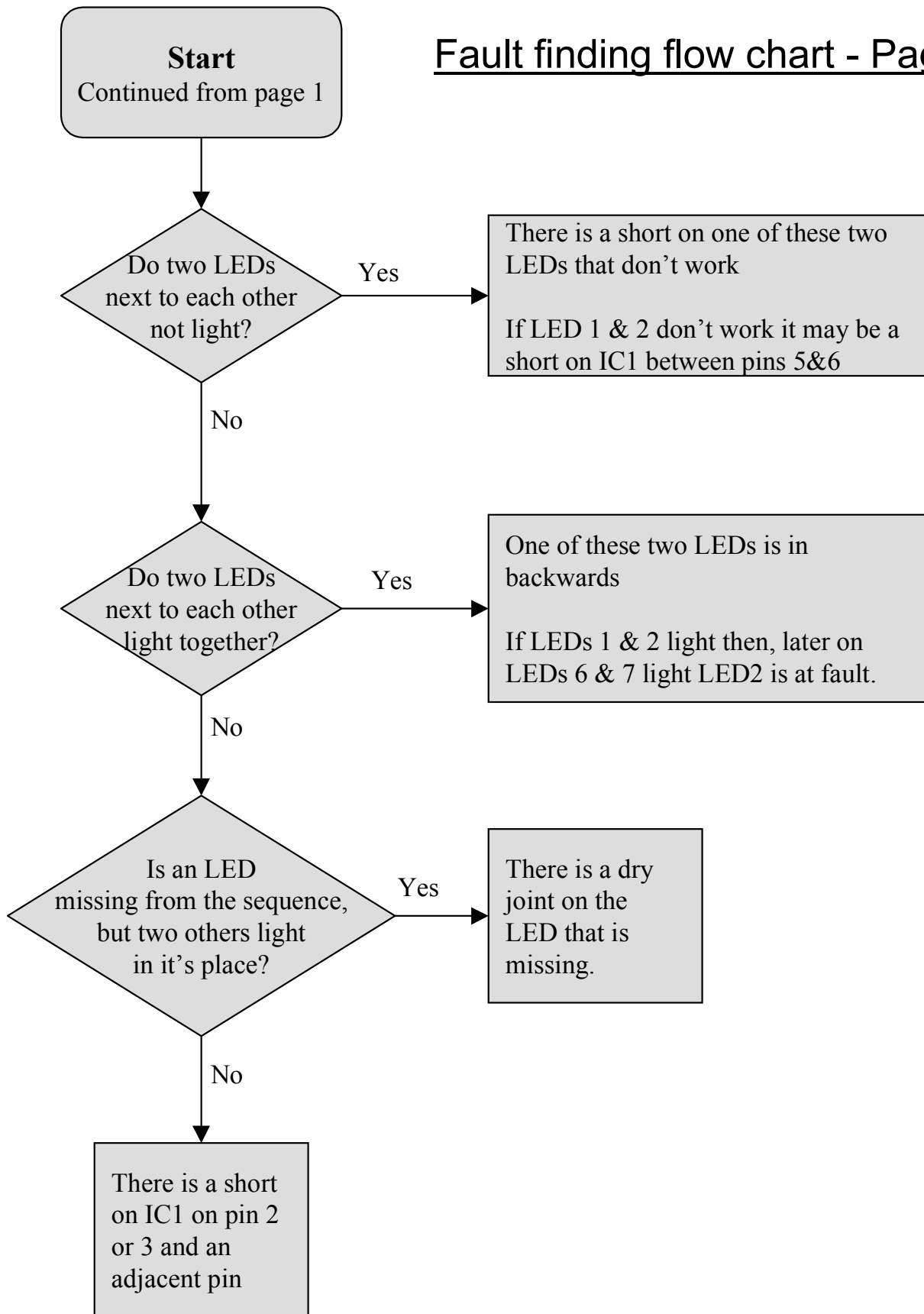

## Designing the Enclosure

When you design the enclosure, you will need to consider:

- The size of the PCB (see below).
- Where the LEDs are mounted and how big they are (see below).
- The size of the battery holder (shown right).

These technical drawings of the thermometer PCB and battery cage should help you to plan this.

All dimensions are in mm.

The LEDs are 5mm in diameter and 9mm tall.

The mounting holes are 3.3mm in diameter.

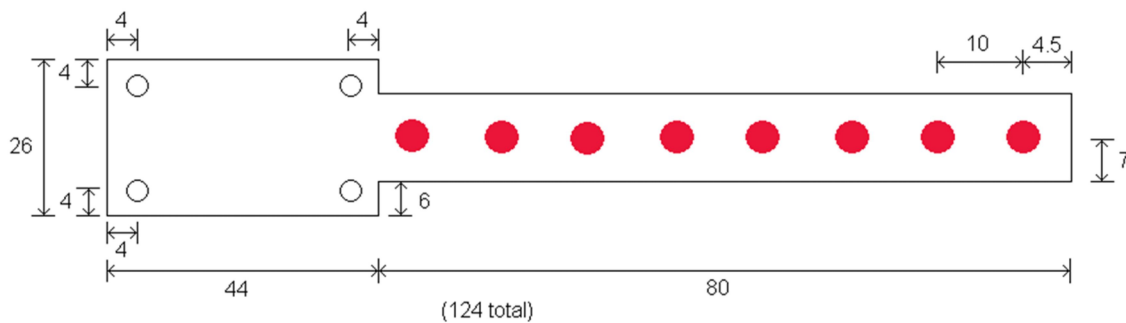
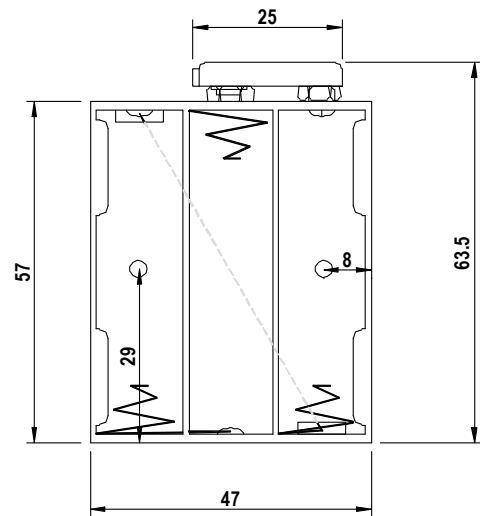

	<p><b>Mounting the PCB to the enclosure</b></p> <p>The drawing to the left shows how a hex spacer can be used with two bolts to fix the PCB to the enclosure.</p> <p><i>Your PCB has four mounting holes designed to take M3 bolts.</i></p>
--	---



## How the Thermometer Project Works

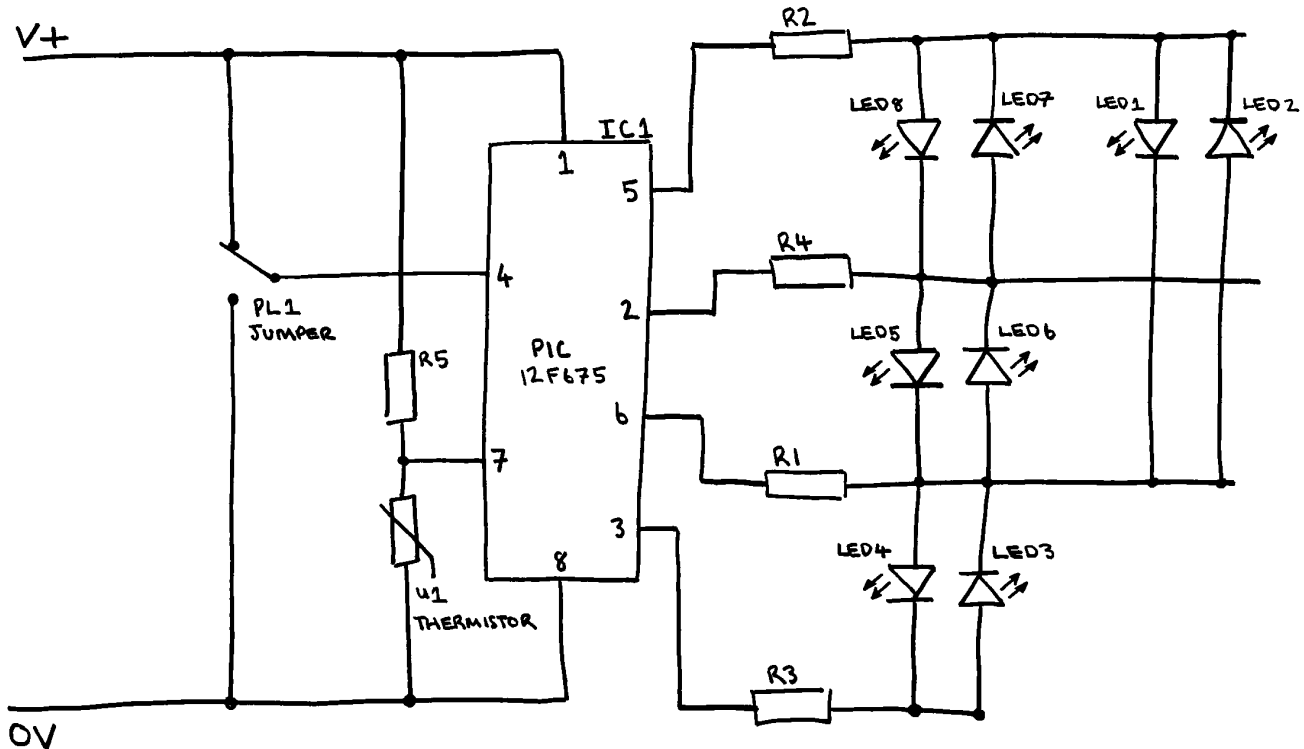

### Calculating the temperature

At the heart of the electronic circuit is a microcontroller. A microcontroller is, in effect, a small computer. One of the inputs to the PIC used is capable of measuring different voltage levels that are fed into it. This is called an analogue input. It is this functionality and the variation in resistance of the thermistor with temperature that are used to calculate the temperature.

The thermistor (U1) has been connected in series with a 2.2kΩ resistor R5 to form what is called a potential divider. Either end of the potential divider is connected between V+ (the positive battery voltage) and 0V. A feed is then taken from the connecting point of R5 to U1 and fed into the PIC's analogue input (pin 7). The voltage fed to pin 7 is determined by the ratio of the resistance of the thermistor (U1) and R5. As the temperature changes and, therefore the resistance of thermistor changes, the voltage on pin 7 changes. It is this voltage level that is used by the PIC to calculate the temperature.

### Displaying the temperature

Once the PIC has calculated the temperature that must be displayed, it has to light up the corresponding LEDs. The circuit uses a clever design to allow eight LEDs to be connected to only four outputs. This is known as multiplexing LEDs. Normally the output pins of the PIC are set so that no LEDs can be on (the PIC pins are set as inputs). When an LED needs to be turned on, the two pins to which it is connected are set to outputs and are driven so that there is a voltage across the LED in the correct direction. For example to turn LED1 on, pin 5 on the PIC needs to be set high and pin 6 set low. LED2 will not be on when this happens as the voltage across it is in the wrong direction for current to flow. The value of resistors R1-R4 is 33Ω. These resistors limit the current that can flow through the LEDs. This protects the LEDs and controls their brightness.





## Online Information

Two sets of information can be downloaded from the product page where the kit can also be reordered from. The 'Essential Information' contains all of the information that you need to get started with the kit and the 'Teaching Resources' contains more information on soldering, components used in the kit, educational schemes of work and so on and also includes the essentials. Download from:

[www.kitronik.co.uk/2110](http://www.kitronik.co.uk/2110)



This kit is designed and manufactured in the UK by Kitronik

---

**Telephone:** +44 (0) 845 8380781

**Sales email:** [sales@kitronik.co.uk](mailto:sales@kitronik.co.uk)

**Tech support email:** [support@kitronik.co.uk](mailto:support@kitronik.co.uk)

**Web:** [www.kitronik.co.uk](http://www.kitronik.co.uk)



[www.kitronik.co.uk/twitter](http://www.kitronik.co.uk/twitter)



[www.kitronik.co.uk/facebook](http://www.kitronik.co.uk/facebook)



[www.kitronik.co.uk/youtube](http://www.kitronik.co.uk/youtube)



[www.kitronik.co.uk/google](http://www.kitronik.co.uk/google)

---

Every effort has been made to ensure that these notes are correct, however Kitronik accept no responsibility for issues arising from errors / omissions in the notes.

© Kitronik Ltd - Any unauthorised copying / duplication of this booklet or part thereof for purposes except for use with Kitronik project kits is not allowed without Kitronik's prior consent.

---

