

REV.	DESCRIPTION	DATE
A	NEW DRAWING	1/3/2006
B	updated PCB layout	2/6/2008
C	added TR package option	11/29/2012

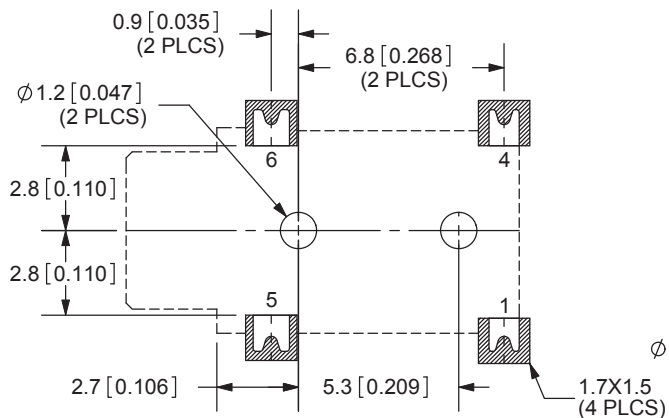

PCB LAYOUT
TOP VIEW

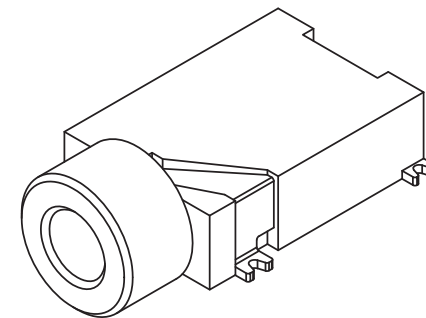
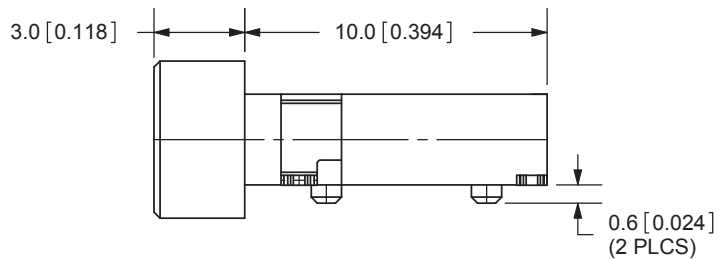
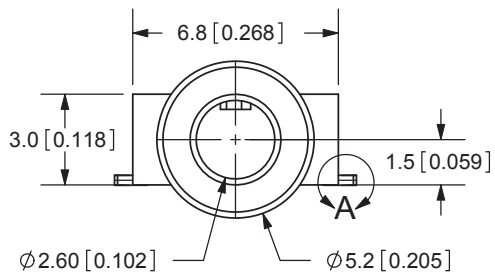
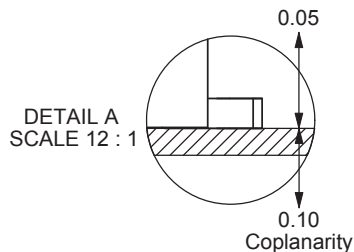
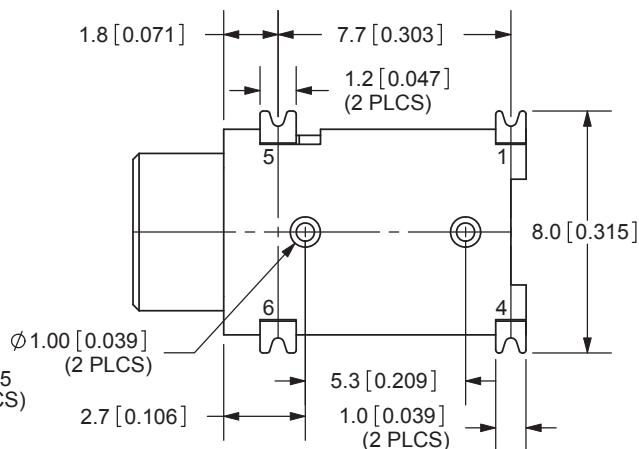

Note:
Add suffix "-TR" to the model number for
tape & reel packaging

TOLERANCE:
X.X ±0.3mm
X.XX ±0.2mm

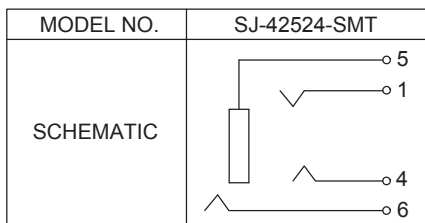

SPECIFICATIONS:
 RATING: 16V DC @ 300mA
 CONTACT RESISTANCE: 100m OHMS MAX
 INSULATION RESISTANCE: 100M OHMS MIN: 500V DC
 VOLTAGE WITHSTAND: 500V AC R.M.S. FOR 1 MINUTE
 LIFE: 5,000 CYCLES
 OPERATING TEMP: -40 ~ +85C

	MATERIAL	PLATING
TERMINAL 1	Titanium Copper	Silver
TERMINAL 4	Titanium Copper	Silver
TERMINAL 5	Phosphor Bronze	Silver
TERMINAL 6	Brass	Gold
HOUSING	PBT	



20050 SW 112th Ave.
 Tualatin, OR 97062
 Phone: 503-612-2300
 800-275-4899
 Fax: 503-612-2383
 Website: www.cui.com

TITLE:	SMT AUDIO JACK W/4 CONDUCTORS 2.5mm	REV:	C
PART NO.	SJ-42524-SMT	UNITS:	MM [INCHES]
DRAWN BY:	ZRJ	APPROVED BY:	
		SCALE:	4:1

PC FILE NAME:
SJ-42524-SMT

COPYRIGHT 2012 BY CUI INC.

REV.	DESCRIP
A	NEW DRAWING
B	updated PCB
C	added TR package

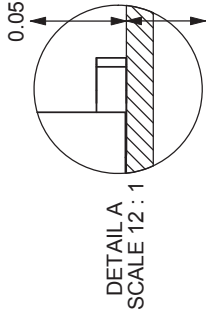

Coplanarity

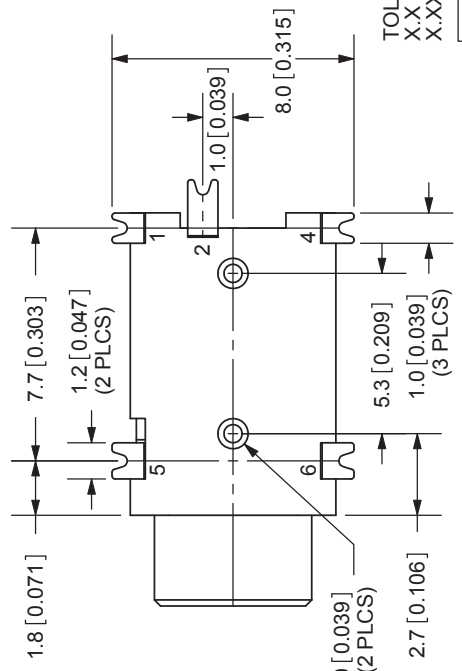
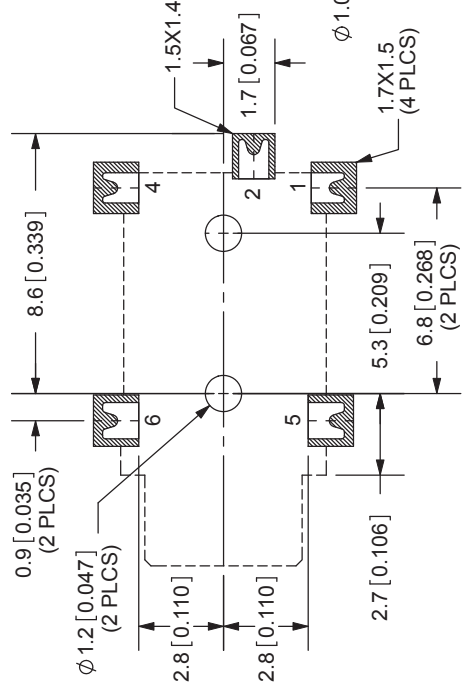
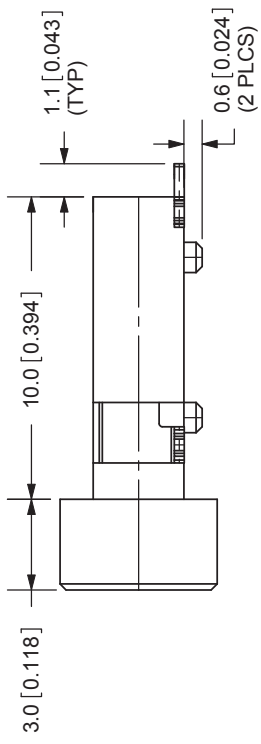
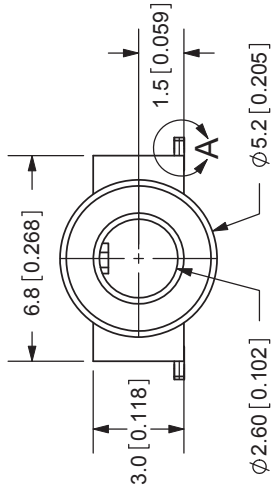

TOLERANCE
X.X ±0.3mm
X.XX ±0.2mm

Note:
Add suffix
tap & r

For more information, please visit the [product page](#).

PCB LAYOUT
TOP VIEW

SPECIFICATIONS:
RATING: 16V DC @ 300mA
CONTACT RESISTANCE: 100m OHMS MAX
INSULATION RESISTANCE: 100M OHMS MIN: 500V DC
VOLTAGE WITHSTAND: 500V AC R.M.S. FOR 1 MINUTE
LIFE: 5,000 CYCLES
OPERATING TEMP: -40 ~ +85C

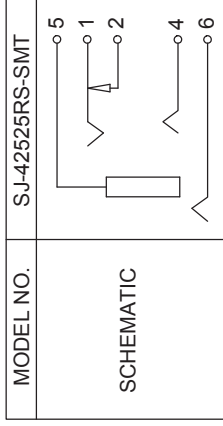

TERMINAL	MATERIAL	PLATING
TERMINAL 1	Titanium Copper	Silver
TERMINAL 2	Brass	Silver
TERMINAL 4	Titanium Copper	Silver
TERMINAL 5	Phosphor Bronze	Silver
TERMINAL 6	Brass	Gold
HOUSING	PBT	

PC FILE NAME:
SJ-42525RS-SMT

COPYRIGHT 2012 BY CUJ, INC.

TITLE: SMT AUDIO JACK
PART NO: SJ-42525R
DRAWN BY: ZRJ

REV.	DESCRIP
A	NEW DRAWING
B	updated PCB
C	housing material
D	added TR package

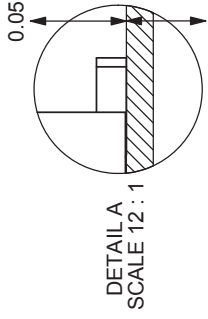

Coplanarity

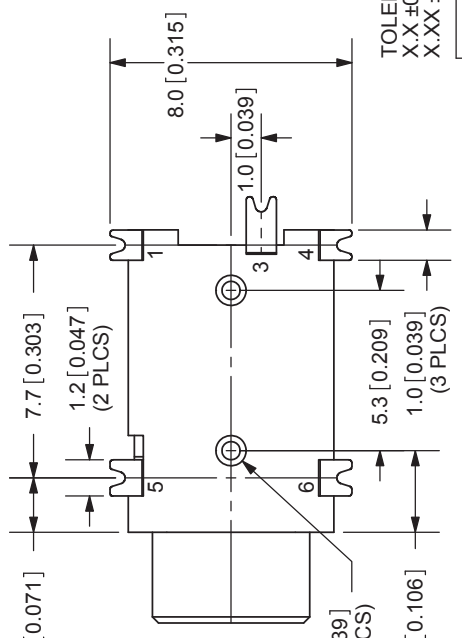
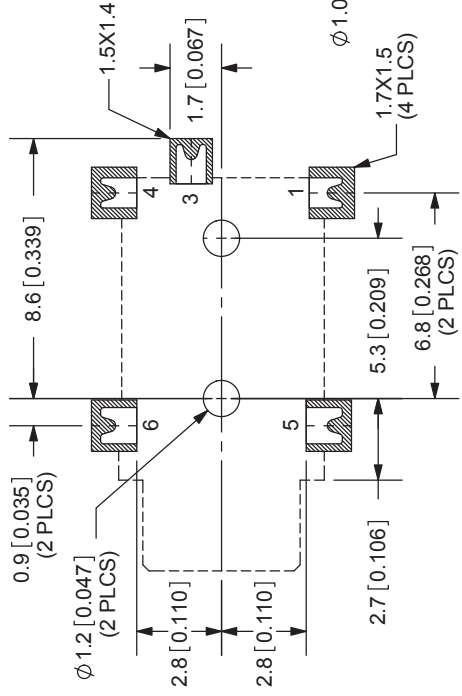
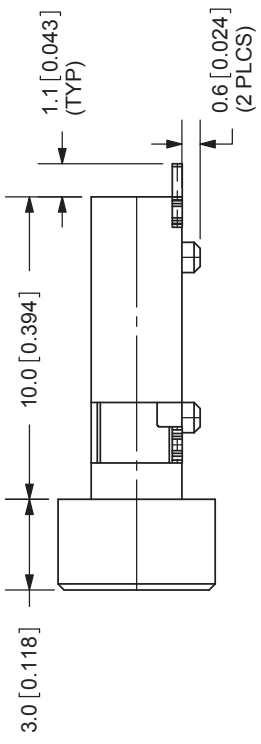
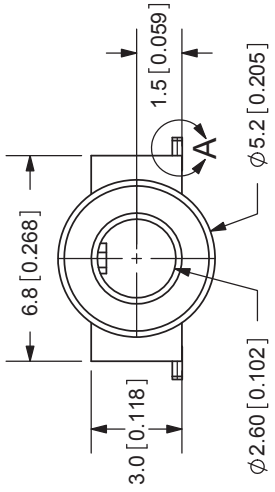

TOLERANCE
X.X ±0.3mm
X.XX ±0.2mm

Note: SMT
Add SMT
taped rework

For more information, please visit the [product page](#).

PCB LAYOUT
TOP VIEW

SPECIFICATIONS:
RATING: 16V DC @ 300mA
CONTACT RESISTANCE: 100m OHMS MAX
INSULATION RESISTANCE: 100M OHMS MIN: 500V DC
VOLTAGE WITHSTAND: 500V AC R.M.S. FOR 1 MINUTE
LIFE: 5,000 CYCLES

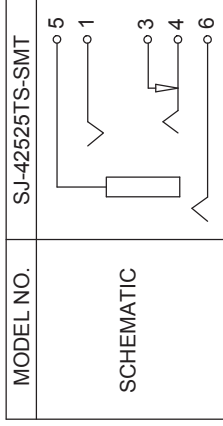

TERMINAL	MATERIAL	PLATING
TERMINAL 1	Titanium Copper	Silver
TERMINAL 3	Brass	Silver
TERMINAL 4	Titanium Copper	Silver
TERMINAL 5	Phosphor Bronze	Silver
TERMINAL 6	Brass	Gold
HOUSING	LCP	

PC FILE NAME:

SJ-42525TS-SMT

COPYRIGHT 2012 BY CUJ INC.

TITLE: SMT AUDIO J

PART NO: SJ-42525T

DRAWN BY: ZRJ

REV.	DESCRIP
A	NEW DRAWING
B	updated PCB
C	housing material
D	added TR package

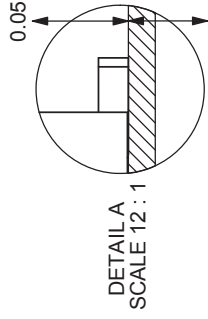

Coplanarity

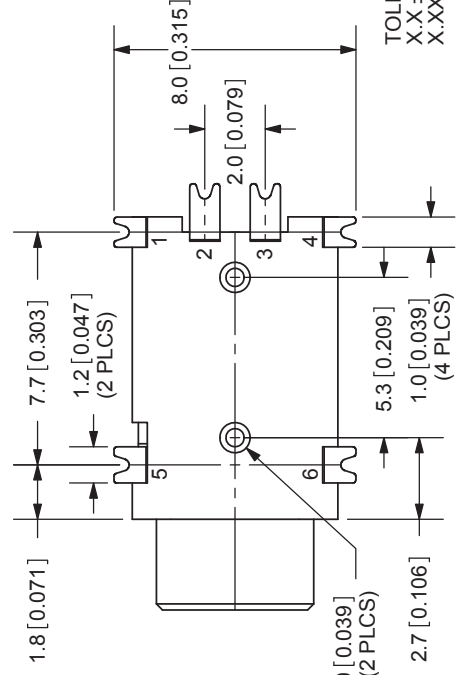
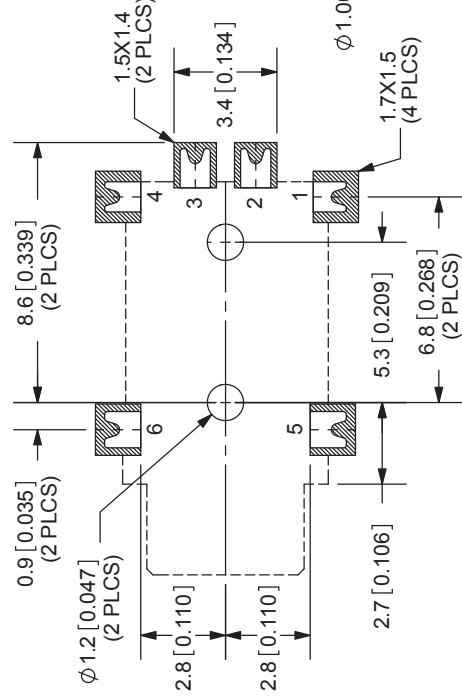
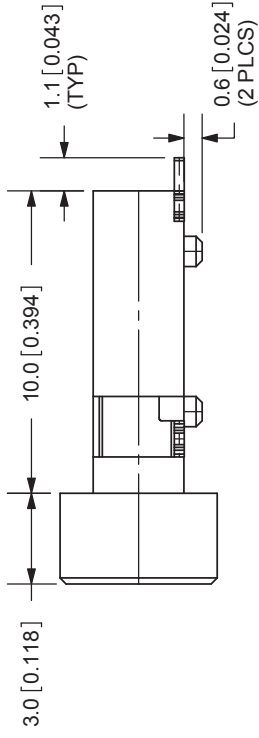
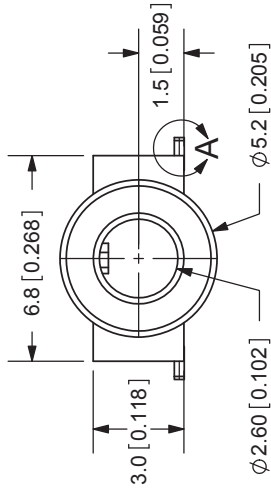

TOLERANCE
X.X ±0.3mm
X.XX ±0.2mm

SPECIFICATIONS:
RATING: 16V DC @ 300mA
CONTACT RESISTANCE: 100m OHMS MAX
INSULATION RESISTANCE: 100M OHMS MIN: 500V DC
VOLTAGE WITHSTAND: 500V AC R.M.S. FOR 1 MINUTE
LIFE: 5,000 CYCLES

PCB LAYOUT
TOP VIEW

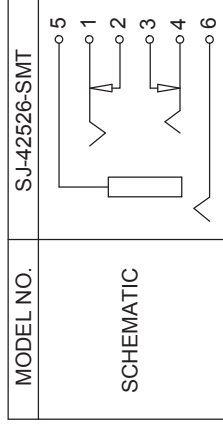

MODEL NO. SJ-42526-SMT

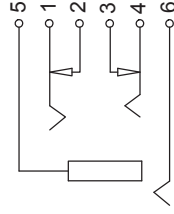

SCHEMATIC

PC FILE NAME:

SJ-42526-SMT

COPYRIGHT 2012 BY CUJ INC.

TERMINAL	MATERIAL	PLATING
TERMINAL 1	Titanium Copper	Silver
TERMINAL 2	Brass	Silver
TERMINAL 3	Brass	Silver
TERMINAL 4	Titanium Copper	Silver
TERMINAL 5	Phosphor Bronze	Silver
TERMINAL 6	Brass	Gold
HOUSING	LCP	

Not for Addressing tape & r
For more information, please visit the [product page.](#)

TITLE: SMT AUDIO J...
PART NO: SJ-42526-S...
DRAWN BY: ZRJ