

Getting Started with MicroView by JP Liew

In order to get your MicroView up and running, there are four easy steps to follow:

1. Prepare MicroView for programming
2. Choose Arduino software
3. Select the right board
4. Run your first sketch

STEP 1 - Prepare MicroView for Programming

Once you have finished the FTDI Drivers installation, you will need to prepare your MicroView to be inserted into the computer's USB port.

If you have purchased the [factory USB Programmer](#), just insert the MicroView into the USB Programmer following the photo below. Please take note that at the back of MicroView, there is a round dot marking showing the Pin 1 of the MicroView where you need to match the Pin 1 of the USB Programmer.

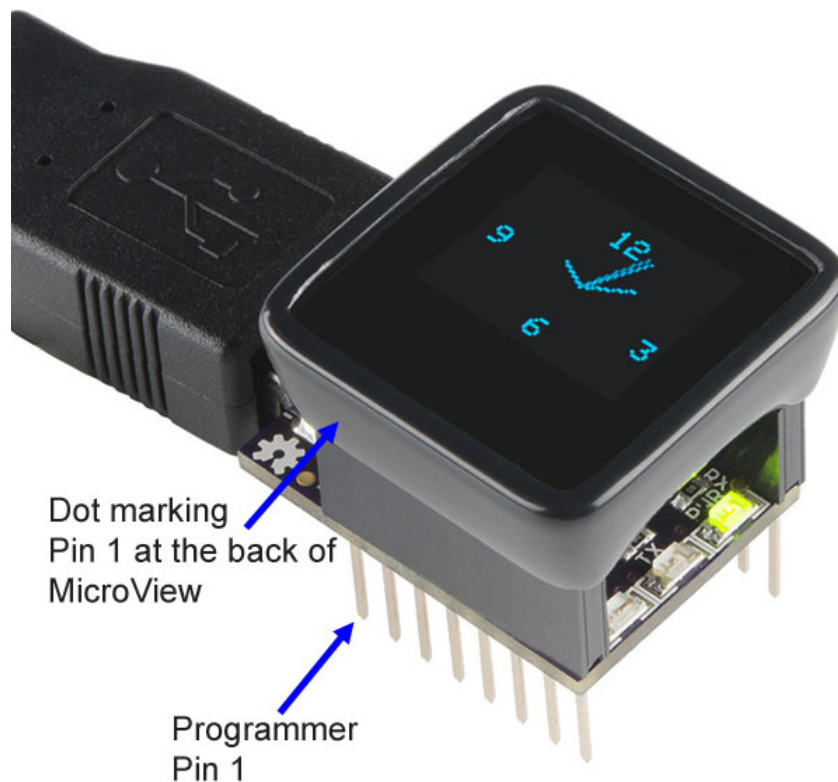

Once you have inserted the MicroView into the USB Programmer, you can now insert the USB Programmer into the USB port of the computer as below. If your computer does not have a right-sided USB port, please use a [USB Cable Extension](#) to extend the USB port to the front so that you can easily work with the MicroView.



If you have not purchase the factory USB Programmer and have a [FTDI Basic Breakout -5V](#) or [FTDI Cable 5V](#) lying around, they can also be used as a MicroView programmer. Connect the FTDI Basic Breakout board as below, and you are ready to go.

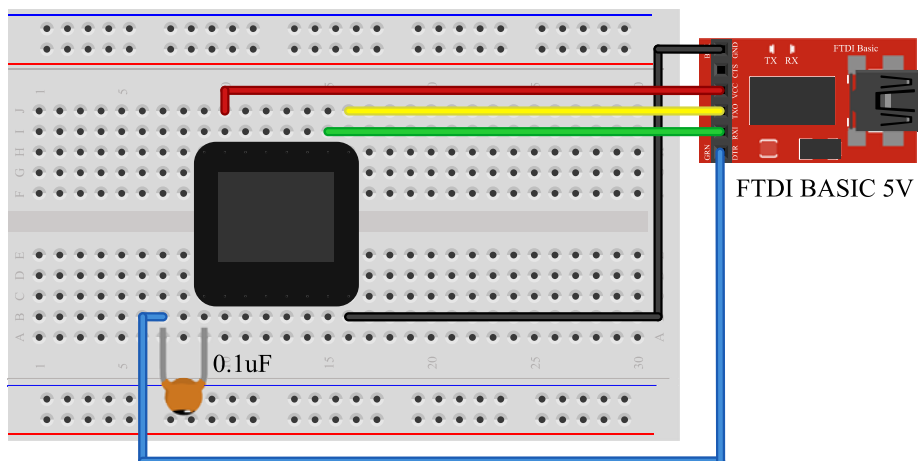

You have now successfully prepared the MicroView for programming.

STEP 2 - Choose the Right Arduino Software (IDE)

There are currently two options when selecting the Arduino Software (IDE). The first option is to use the cloud based [Codebender](#) and the second option is to use [Arduino IDE](#).

As our Learning Kit's tutorials are based on Codebender, and Codebender has already included MicroView's library in their cloud solution, we highly recommend users to use Codebender for our tutorials. Plus Codebender has made the drivers installation really straight forward and easy.

Using Codebender

Installing Codebender is really simple, the prerequisite is just a Chrome or Firefox web-browser. Using Chrome or Firefox, browse to [Codebender's Getting Started page](#) and then follow the steps below (shown using Firefox).

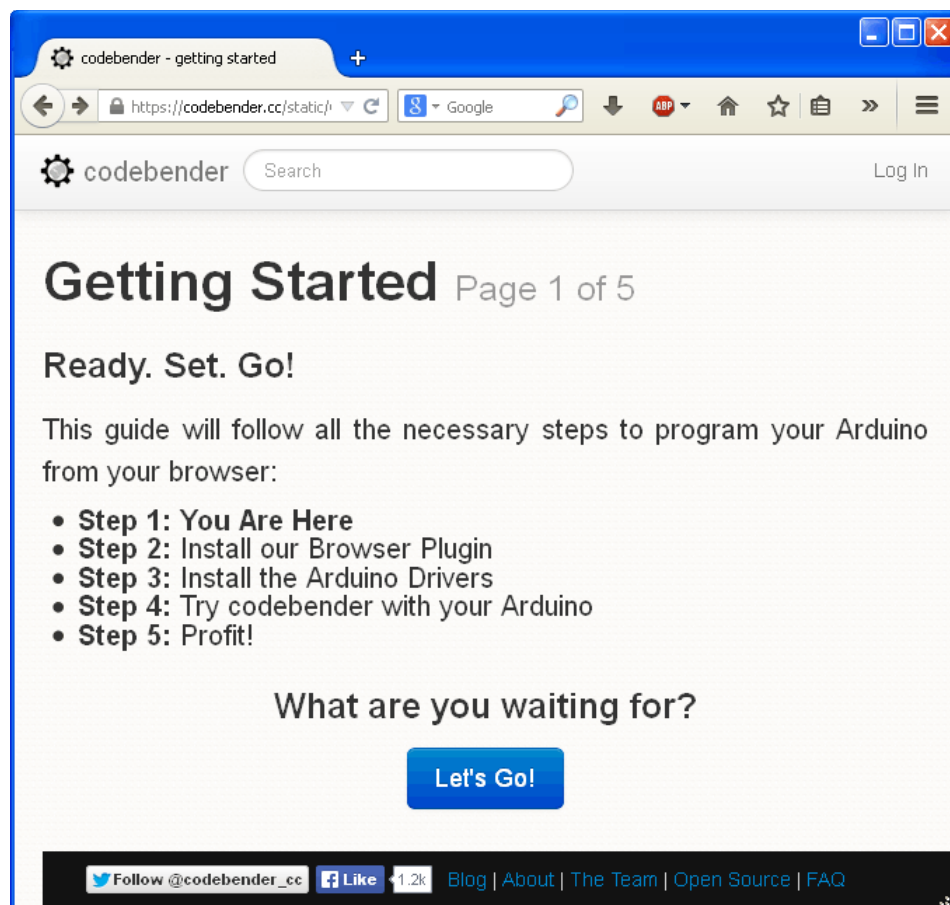

Click

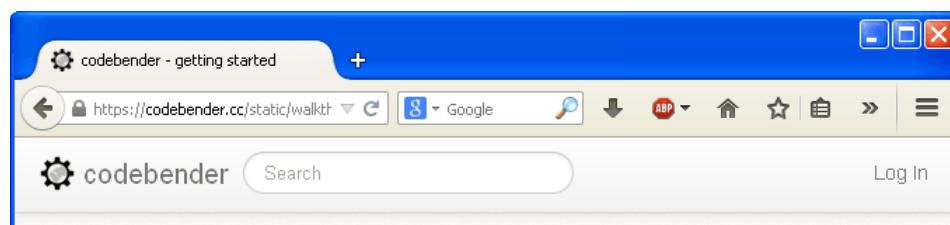

Getting Started Page 2 of 5

To program your Arduino, install the Codebender Plugin. [Add to Firefox.](#)

After installing the plugin, please restart Firefox to continue.

Follow @codebender_cc Like 1.2k Blog | About | The Team | Open Source | FAQ

Click

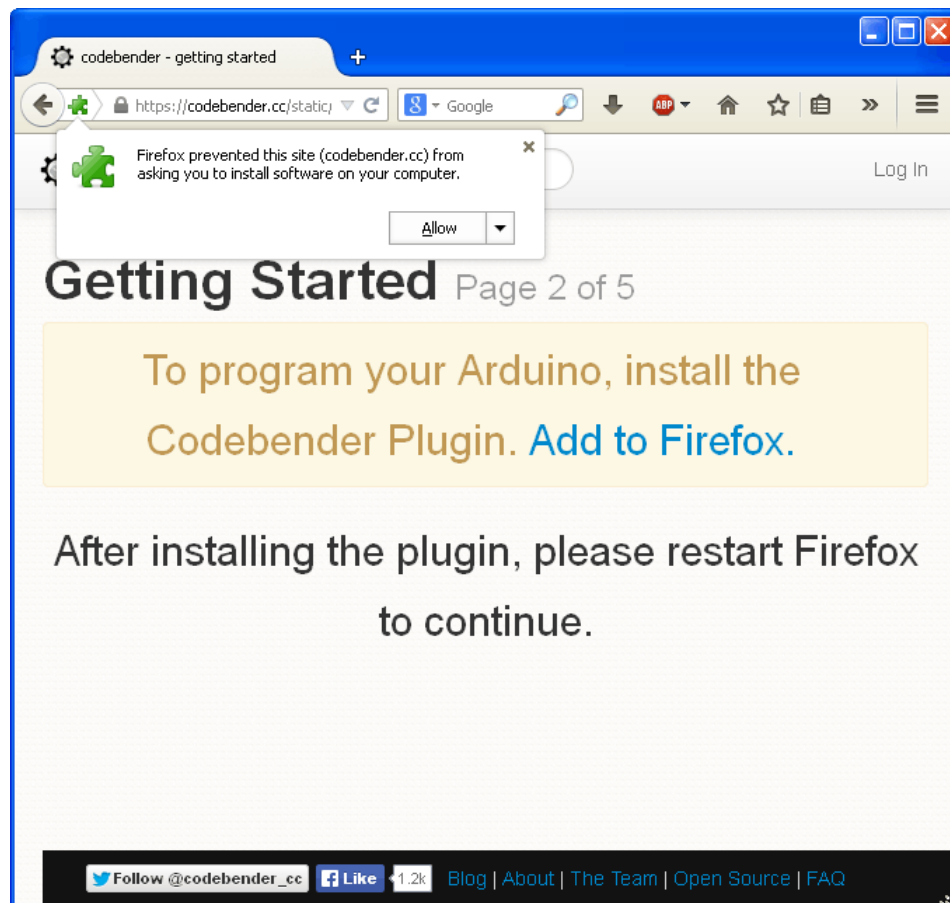

Click **Allow** when you see the message “Firefox prevented this site (codebender.cc) from asking you to install software on your computer.”

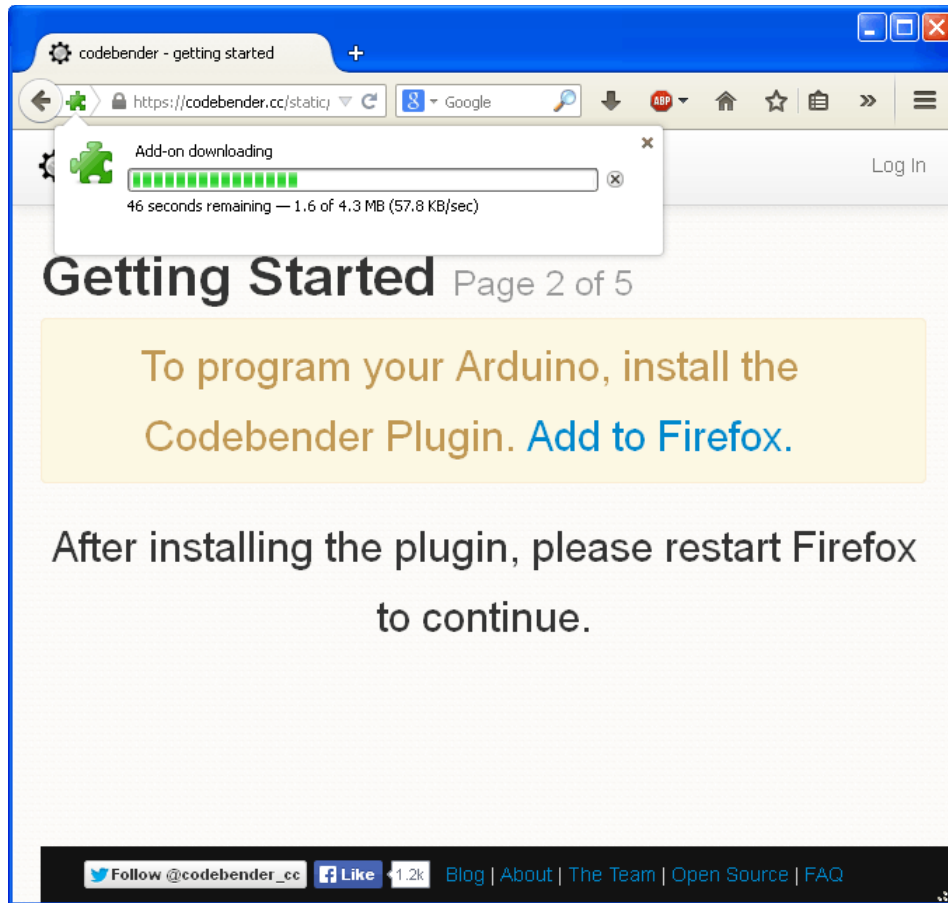

Wait for the **Add-on downloading** to finish.

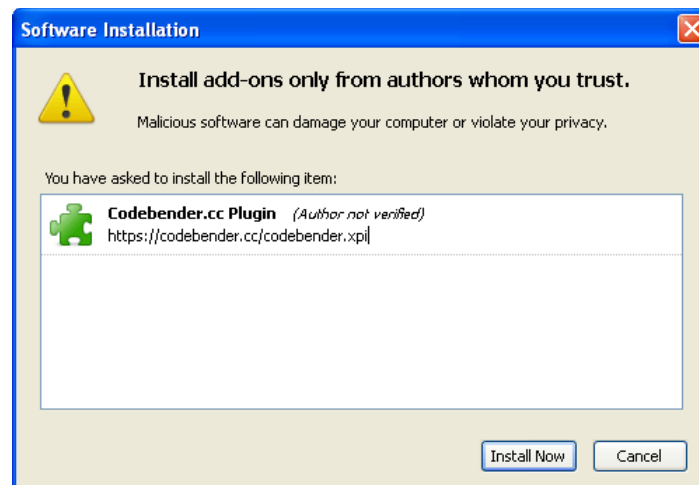

Click **Install Now**

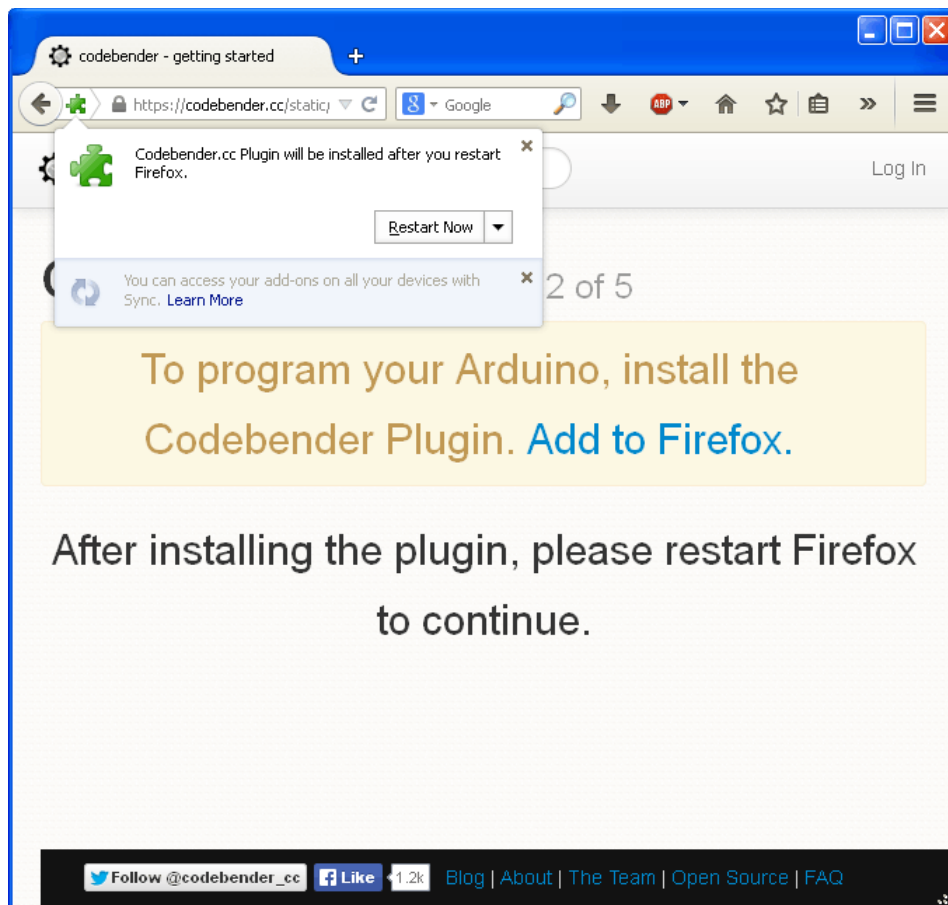

Click `Restart Now` when you see the message "Codebender.cc Plugin will be installed after you restart Firefox."

After restarting, the browser will load up a Driver Installation page.

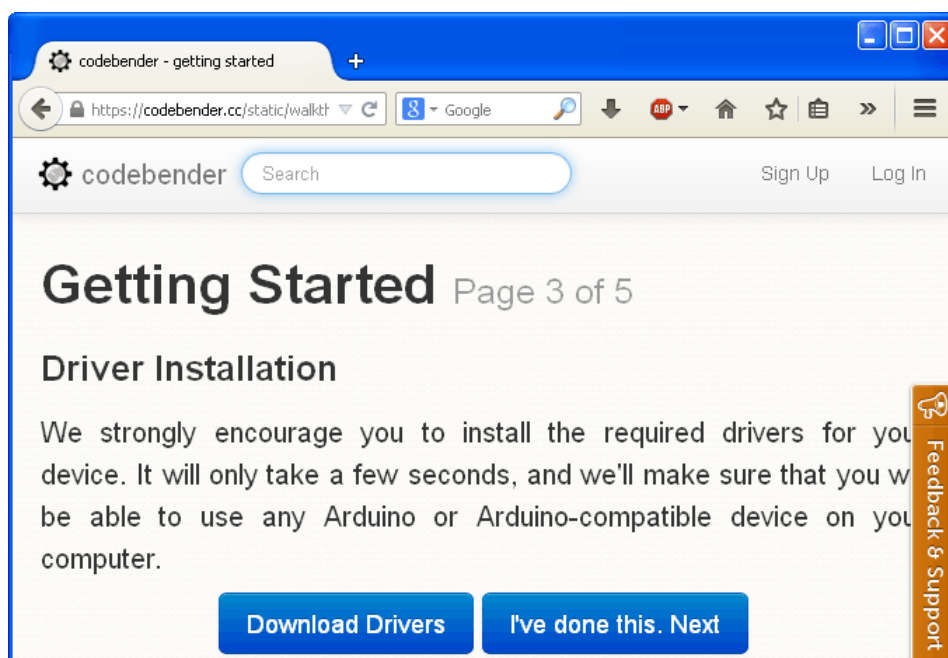



Click [Download Drivers](#) and save the driver zip file in your preferred folder. When the download is finished, click to open the zip file and then execute the driver installation file.

After the drivers have been successfully installed, a success page will be displayed.

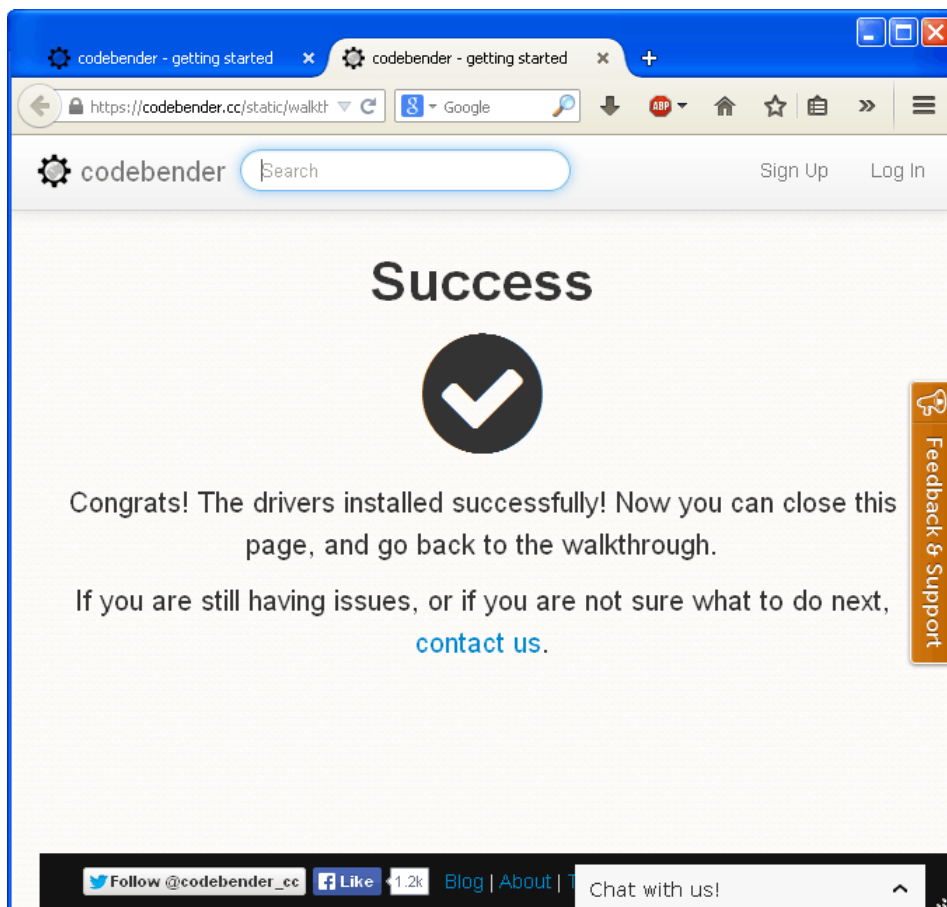

You have now successfully installed the Codebender plugin on your browser. Please proceed to STEP 4 – Run Your First Sketch

Install Arduino IDE

Before installing Arduino IDE, it is recommended to install the USB programmer's driver first.

Install Drivers

MicroView, like the Arduino, relies on a programmer to upload sketches (Arduino code) and also communicate with the computer. This programmer often has a USB to TTL converter chip that creates a Virtual Serial Port on the computer when properly installed. MicroView's [factory USB Programmer](#) uses the [FTDI's FT231X](#) to send the sketches to MicroView and also act as a communication medium between MicroView and the computer.

Depending on the OS (Operating System) of your computer, the drivers are installed using different methods. Below are the installation instructions prepared by SparkFun Electronics:

- [How to Install FTDI Drivers for Windows](#)
- [How to Install FTDI Drivers for Linux](#)
- [How to Install FTDI Drivers for Mac](#)

Install IDE

Installing the Arduino IDE is normally straight forward, however it is still a bit challenging if one has never try before. Luckily our partner SparkFun have already published step by step guides on:

- [Installing Arduino IDE for Windows](#)
- [Installing Arduino IDE for Mac](#)
- [Installing Arduino IDE for Linux](#)

After installation of the Arduino IDE has completed, unlike Codebender, you will still need to install MicroView's library.

Install MicroView Library

Download MicroView's library from our Github repo below:

[MicroView Library Github Repo](#)

Save the ZIP file to your download folder then unzip the ZIP file. Rename the folder name from

`MicroView-Arduino-Library-master` to `MicroView`.

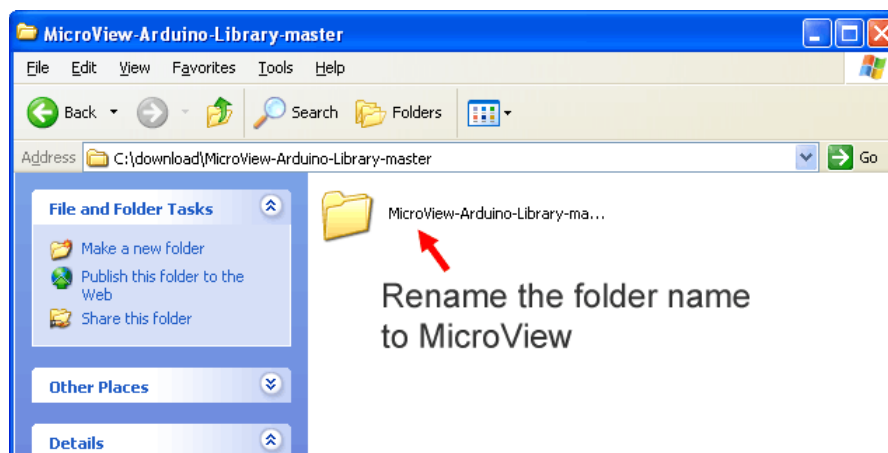



Open the Arduino IDE, click Sketch, Import Library and then Add Library.

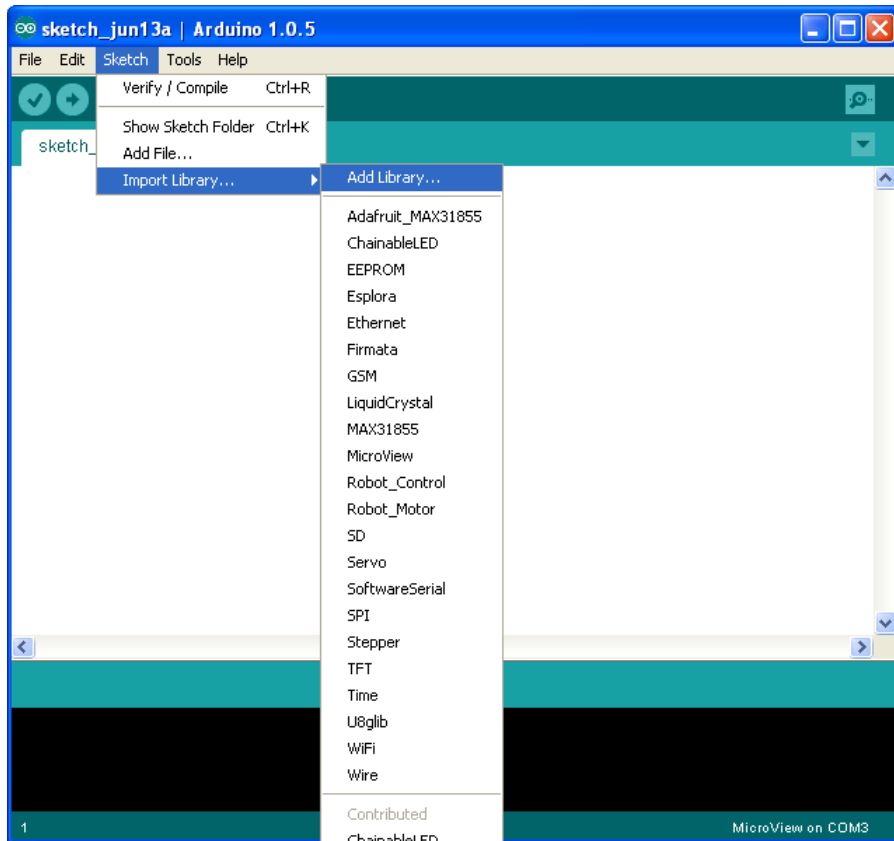

Browse to the `MicroView` folder that was renamed and select that folder. The MicroView library will be automatically installed.

Click File, Example, and find MicroView Example to confirm the installation.

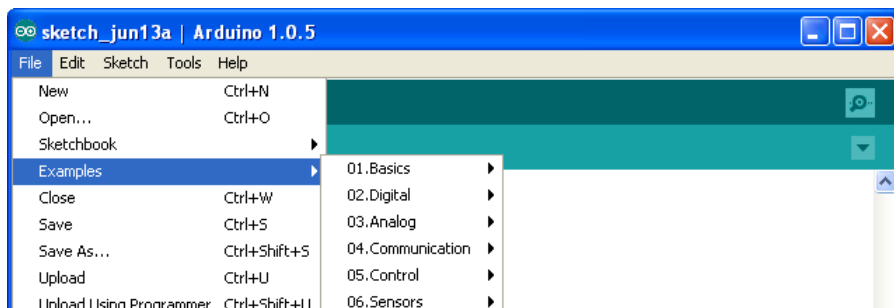

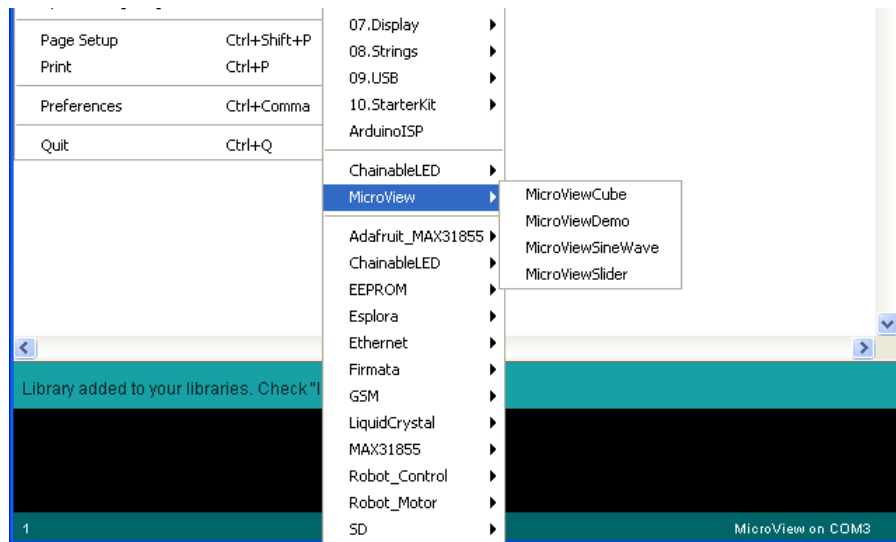

If you wish to compile and upload the MicroViewDemo from our example, there is a 3rd party Time library that is required to be installed. [Download the Time library](#) and use the same library installation method discussed above to install it into the Arduino IDE.

The Arduino IDE requires users to manually manage and install 3rd party libraries, for a ready to go development environment, we recommend Codebender.

STEP 3 - Select the Right Board

If you are using Codebender, the MicroView is fully supported and will be automatically selected in all our examples. Proceed to STEP 4 and click `Run on Arduino` to run your first sketch.

In the Arduino IDE, click Tools, board and select Arduino Uno. Due to the nature of Arduino IDE being not able to detect a board, the COM port (Serial Port) of the MicroView USB Programmer needs to be manually selected by clicking Tools, Serial Port and select the right port that was created in the previous driver installation. Click Upload to upload your first sketch to MicroView.

MicroView is using the same bootloader as Uno. It behaves like an Uno when uploading sketches.

For advance user that like to see MicroView as a board by itself in the IDE, add the following board definition to the `boards.txt` file. Depending on your setup, the `boards.txt` file usually located at `arduino-version\hardware\arduino` folder. Replace `arduino-version` with the right folder name for your Arduino version installed in your computer.

```
uview.upload.tool=avrdude
uview.bootloader.tool=avrdude
```

```

uview.name=MicroView
uview.upload.protocol=arduino
uview.upload.maximum_size=32256
uview.upload.speed=115200
uview.bootloader.low_fuses=0xff
uview.bootloader.high_fuses=0xde
uview.bootloader.extended_fuses=0x05
uview.bootloader.path=optiboot
uview.bootloader.file=optiboot_atmega328.hex
uview.bootloader.unlock_bits=0x3F
uview.bootloader.lock_bits=0x0F
uview.build.mcu=atmega328p
uview.build.f_cpu=1600000L
uview.build.core=arduino
uview.build.variant=standard

```

STEP 4 - Run Your First Sketch

If you have installed Codebender, select the right COM port and then click **Run on Arduino** to upload your first sketch to MicroView. Watch the TX (red) and RX (yellow) LED blinks while the sketch is being uploaded to the MicroView.

Hello World (https://codebender.cc/sketch:38829) by MicroView (https://codebender.cc/sketch:38829) Download
 (? (https://codebender.cc/sketch:38829) referrer=MicroView)

```

1 #include <MicroView.h>
2
3 void setup() {
4   uView.begin();           // start MicroView
5   uView.clear(PAGE);      // clear page
6   uView.print("HelloWorld"); // display HelloWorld
7   uView.display();
8 }
9
10 void loop () {}

```

Searching for plugin ...
 Loading Boards... [v] [v] → Run on Arduino

Arduino IDE users just need to cut and paste the above sketch starting from #include to ... void loop () {} into the Arduino IDE and click upload.

Well done! You are now ready to try our other tutorials.

Published 04 May 2014

microView
arduino ide

setup
microview library

getting started
codebender
