

ELECTRICAL SPECIFICATIONS:

- 1.0 TURNS RATIO: (P4-P5-P6) : (J3-J6) : 1CT : 1CT ± 3%  
(P3-P2-P1) : (J1-J2) : 1CT : 1CT ± 3%
- 2.0 INDUCTANCE: (P6-P4) : 350uH MIN. @ 0.1V, 100KHz, 8mA DC Bias  
(P3-P1) : 350uH MIN. @ 0.1V, 100KHz, 8mA DC Bias
- 3.0 LEAKAGE INDUCTANCE: P6-P5-P4 (WITH J6 AND J3 SHORT) : 0.3 MAX. @ 1MHZ  
P3-P2-P1 (WITH J2 AND J1 SHORT) : 0.3 MAX. @ 1MHZ
- 4.0 INTERWINDING CAPACITANCE: (P6,P5,P4) TO (J6,J3) : 30pf MAX @ 1MHZ  
(P3,P2,P1) TO (J2,J1) : 30pf MAX. @ 1MHZ
- 5.0 DC RESISTANCE: (J6-J3)=(J2-J1) : 1.2 ohms Max.

NOTES

1.0 PINS WITHOUT ELECTRICAL CONNECTION ARE OMITTED.

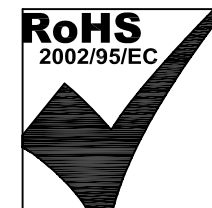

Bel Stewart Connector  
11118 Susquehanna Trail, South  
Glen Rock, Pa 17327-9199  
717.234.7512

**MagJack®**

<http://www.stewartconnector.com>

THIS DRAWING AND THE SUBJECT MATTER SHOWN THEREON ARE CONFIDENTIAL AND PROPERTY OF BEL STEWART CONNECTOR AND SHALL NOT BE REPRODUCED, COPIED, OR USED IN ANY MANNER WITHOUT PRIOR WRITTEN CONTENT OF BEL STEWART CONNECTOR. THE SUBJECT MATTER MAY BE PATENTED OR A PATENT MAY BE PENDING.

SHEET 1 OF 4

DRAWING NO. SI-70019-F REV. 06

RECEIVE

- 6.0 RETURN LOSS: (P6-P4)=100 OHMS AND (P1-P3)=100 OHM REF.  
1MHz TO 30MHz : 18dB MIN.  
30MHz TO 80MHz : 12dB MIN.
- NOTE: 100 OHMS CONNECTED TO (J2-J1) OR (J6-J3).
- 7.0 DIELECTRIC WITHSTAND: (J1, J2) TO (P1, P3) : 1500 VAC  
(J3, J6) TO (P4,P6) : 1500 VAC
- 8.0 INSERTION LOSS: RS=RL=100 ohms  
100kHz TO 100MHz : 1.1 dB TYP
- 9.0 RISE TIME: RS=100 OHMS AND RL = 100 OHMS  
OUTPUT VOLTAGE = 1 V peak : 3.0 nS MAX  
PULSE WIDTH= 112nS : 3.0 nS MAX
- 10.0 CROSS TALK: 1-100 MHz : 40 dB TYP
- 11.0 COMMON TO COMMON MODE ATTENUATION: 1MHz TO 100MHz : 35dB TYP

Bel Stewart Connector  
11118 Susquehanna Trail, South  
Glen Rock, Pa 17327-9199  
717.234.7512

**MagJack®**

<http://www.stewartconnector.com>

THIS DRAWING AND THE SUBJECT MATTER SHOWN THEREON ARE CONFIDENTIAL AND PROPERTY OF BEL STEWART CONNECTOR AND SHALL NOT BE REPRODUCED, COPIED, OR USED IN ANY MANNER WITHOUT PRIOR WRITTEN CONTENT OF BEL STEWART CONNECTOR. THE SUBJECT MATTER MAY BE PATENTED OR A PATENT MAY BE PENDING.

SHEET 2 OF 4

DRAWING NO. SI-70019-F

REV. 06

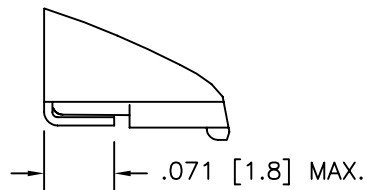
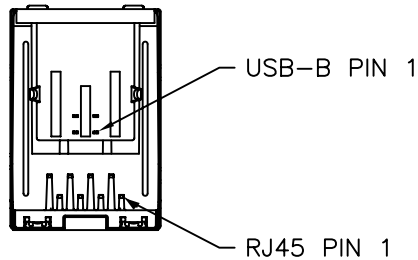
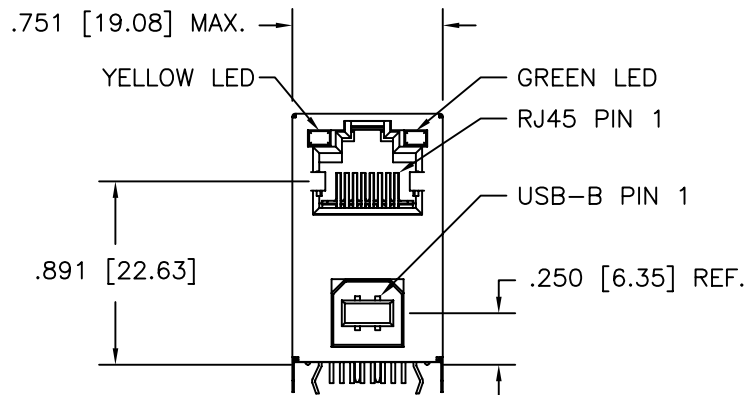

DETAIL A  
SCALE 5=1

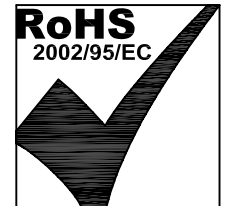
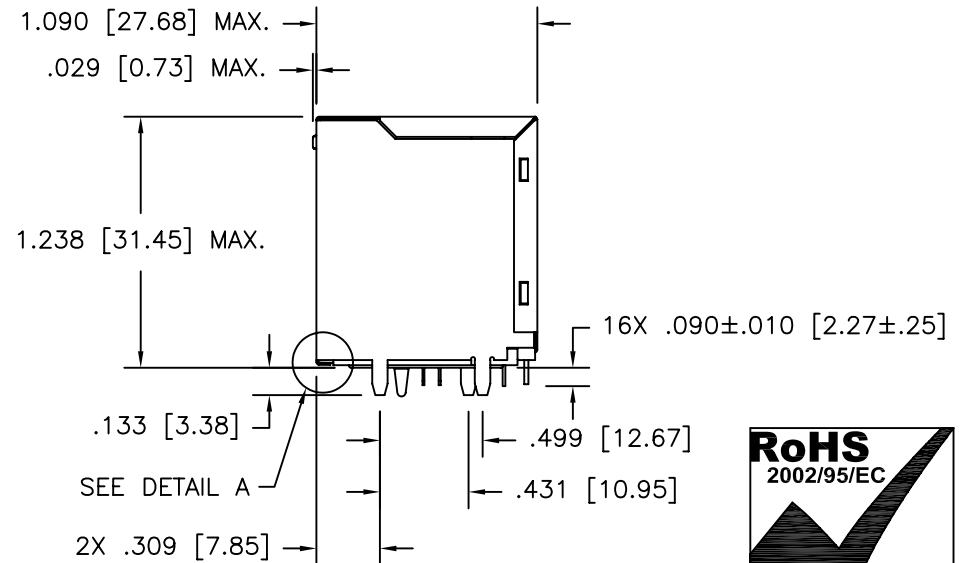
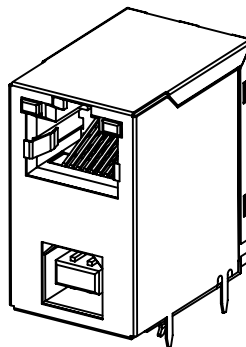

NOTES:

1. CONNECTOR MATERIALS:  
HOUSING: THERMOPLASTIC UL94 V-0  
CONTACT/SHIELD: COPPER ALLOY  
SHIELD PLATING: NICKEL OR TIN  
CONTACT PLATING: SELECTIVE GOLD,  
50 MICRO-INCHES MIN. IN CONTACT AREA.
2. PIN NOT ELECTRICALLY CONNECTED MAYBE OMITTED.  
SEE ELECTRICAL DRAWING FOR OMITTED PINS.
3. TOLERANCES COMPLY WITH F.C.C. DIMENSION REQUIREMENTS.
4. ALL TOLERANCES NOT OTHERWISE SPECIFIED TO BE ±.005 [0.13]
5. WAVE SOLDER COMPATIBLE - PREHEAT 125°C/90SECS.

Bel Stewart Connector  
11118 Susquehanna Trail, South  
Glen Rock, Pa 17327-9199  
717.234.7512



<http://www.stewartconnector.com>

THIS DRAWING AND THE SUBJECT MATTER SHOWN THEREON ARE CONFIDENTIAL AND PROPERTY OF BEL STEWART CONNECTOR AND SHALL NOT BE REPRODUCED, COPIED, OR USED IN ANY MANNER WITHOUT PRIOR WRITTEN CONTENT OF BEL STEWART CONNECTOR. THE SUBJECT MATTER MAY BE PATENTED OR A PATENT MAY BE PENDING.

SHEET  
3 OF 4

DRAWING NO. SI-70019-F REV. 04

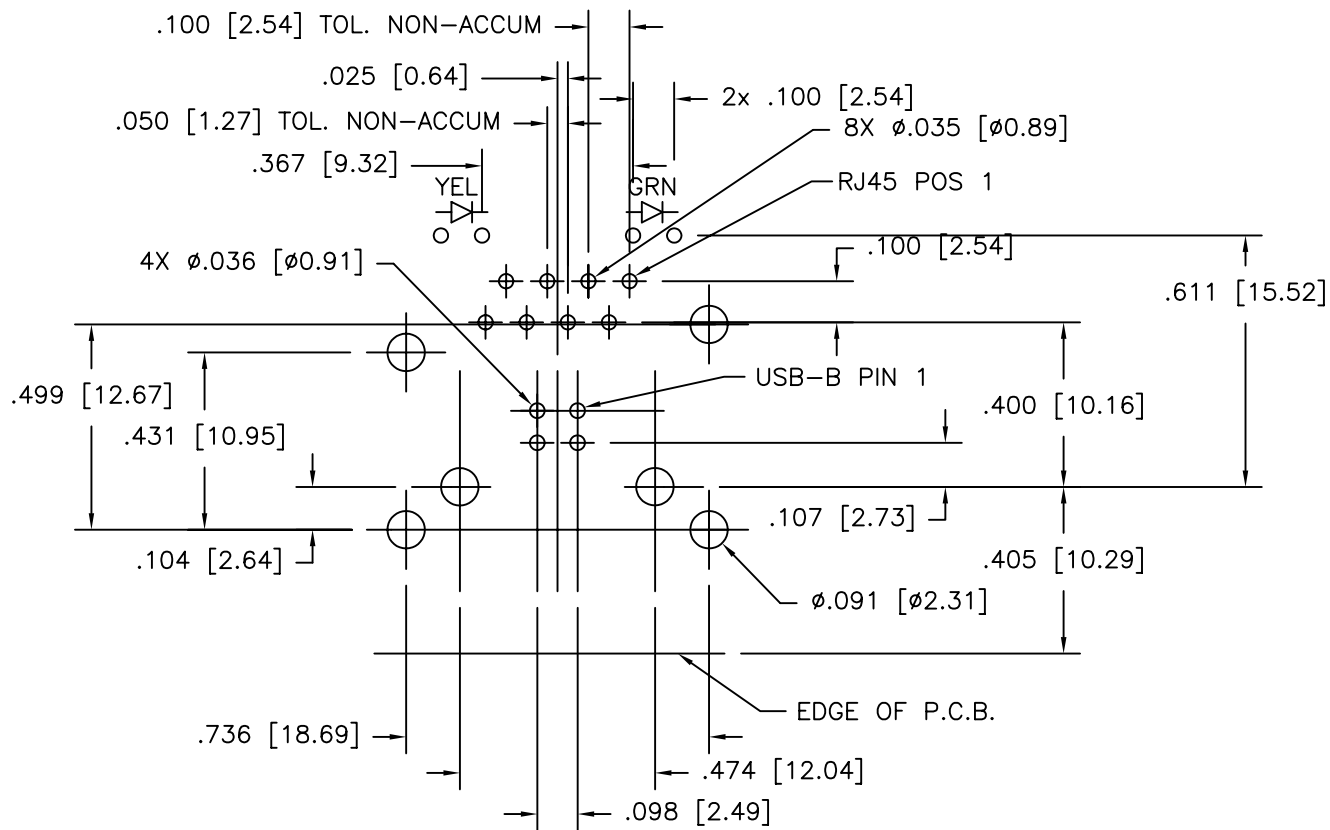

PC BOARD LAYOUT COMPONENT SIDE SHOWN  
 TOLERANCE:  $\pm$ .003 [.08] UNLESS OTHERWISE SPECIFIED

Bel Stewart Connector  
 11118 Susquehanna Trail, South  
 Glen Rock, Pa 17327-9199  
 717.234.7512

**MagJack®**

<http://www.stewartconnector.com>

THIS DRAWING AND THE SUBJECT MATTER SHOWN THEREON ARE CONFIDENTIAL AND PROPERTY OF BEL STEWART CONNECTOR AND SHALL NOT BE REPRODUCED, COPIED, OR USED IN ANY MANNER WITHOUT PRIOR WRITTEN CONTENT OF BEL STEWART CONNECTOR. THE SUBJECT MATTER MAY BE PATENTED OR A PATENT MAY BE PENDING.

SHEET 4 OF 4

DRAWING NO. SI-70019-F

REV. 04