



**User Manual**

# SOM-6763 B1

**ADVANTECH**

*Enabling an Intelligent Planet*

---

## Copyright

The documentation and the software included with this product are copyrighted 2010 by Advantech Co., Ltd. All rights are reserved. Advantech Co., Ltd. reserves the right to make improvements in the products described in this manual at any time without notice.

No part of this manual may be reproduced, copied, translated or transmitted in any form or by any means without the prior written permission of Advantech Co., Ltd. Information provided in this manual is intended to be accurate and reliable. However, Advantech Co., Ltd. assumes no responsibility for its use, nor for any infringements of the rights of third parties, which may result from its use.

## Acknowledgements

AMI is a trademark of American Megatrends Inc.

VIA is a trademark of VIA Technologies, Inc.

IBM, PC/AT, PS/2 and VGA are trademarks of International Business Machines Corporation.

Intel and Pentium are trademarks of Intel Corporation.

Microsoft Windows® is a registered trademark of Microsoft Corp.

RTL is a trademark of Realtek Semi-Conductor Co., Ltd.

ESS is a trademark of ESS Technology, Inc.

UMC is a trademark of United Microelectronics Corporation.

SMI is a trademark of Silicon Motion, Inc.

Creative is a trademark of Creative Technology LTD.

CHRONTEL is a trademark of Chrontel Inc.

All other product names or trademarks are properties of their respective owners.

## Product Warranty (2 years)

Advantech warrants to you, the original purchaser, that each of its products will be free from defects in materials and workmanship for two years from the date of purchase.

This warranty does not apply to any products which have been repaired or altered by persons other than repair personnel authorized by Advantech, or which have been subject to misuse, abuse, accident or improper installation. Advantech assumes no liability under the terms of this warranty as a consequence of such events.

Because of Advantech's high quality-control standards and rigorous testing, most of our customers never need to use our repair service. If an Advantech product is defective, it will be repaired or replaced at no charge during the warranty period. For out-of-warranty repairs, you will be billed according to the cost of replacement materials, service time and freight. Please consult your dealer for more details.

If you think you have a defective product, follow these steps:

1. Collect all the information about the problem encountered. (For example, CPU speed, Advantech products used, other hardware and software used, etc.) Note anything abnormal and list any onscreen messages you get when the problem occurs.
2. Call your dealer and describe the problem. Please have your manual, product, and any helpful information readily available.
3. If your product is diagnosed as defective, obtain an RMA (return merchandise authorization) number from your dealer. This allows us to process your return more quickly.
4. Carefully pack the defective product, a fully-completed Repair and Replacement Order Card and a photocopy proof of purchase date (such as your sales receipt) in a shippable container. A product returned without proof of the purchase date is not eligible for warranty service.
5. Write the RMA number visibly on the outside of the package and ship it prepaid to your dealer.

## Declaration of Conformity

### CE

This product has passed the CE test for environmental specifications. Test conditions for passing included the equipment being operated within an industrial enclosure. In order to protect the product from being damaged by ESD (Electrostatic Discharge) and EMI leakage, we strongly recommend the use of CE-compliant industrial enclosure products.

### FCC Class A

Note: This equipment has been tested and found to comply with the limits for a Class A digital device, pursuant to part 15 of the FCC Rules. These limits are designed to provide reasonable protection against harmful interference when the equipment is operated in a commercial environment. This equipment generates, uses, and can radiate radio frequency energy and, if not installed and used in accordance with the instruction manual, may cause harmful interference to radio communications. Operation of this equipment in a residential area is likely to cause harmful interference in which case the user will be required to correct the interference at his own expense.

# COM Design Support

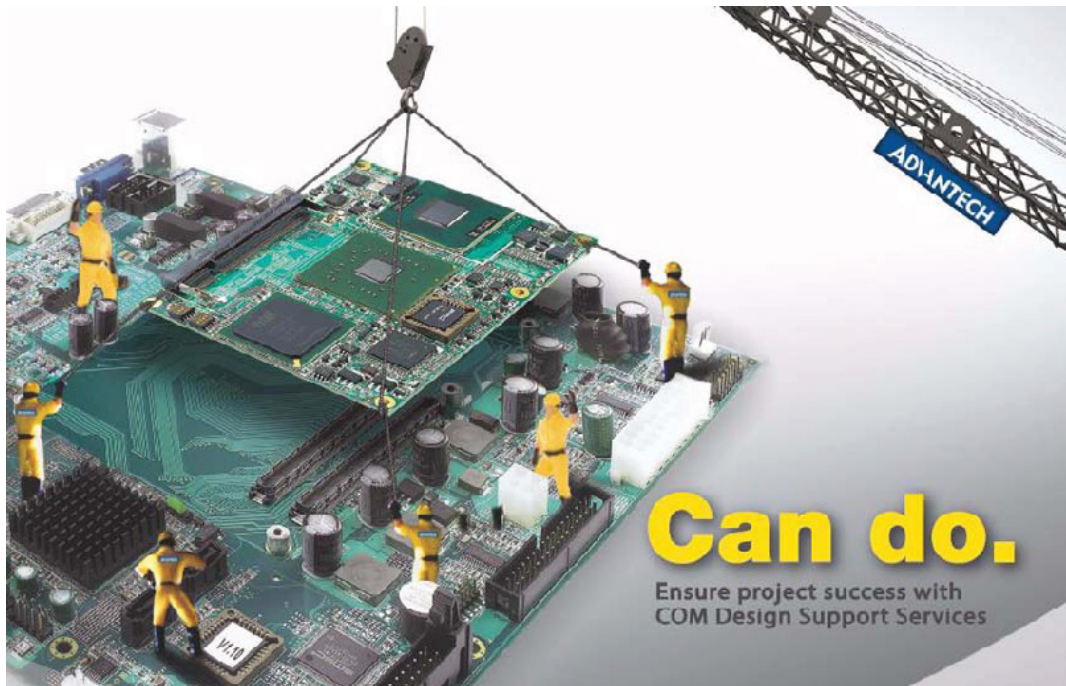

## A Series of Value-Added Services for Carrier Board Development

Advantech COM Design Support Services help customers to reduce the time and work involved with designing new carrier boards. We handle the complexities of technical research and greatly minimize the development risk associated with carrier boards.

### COM Product & Support Services

- Full Range of COM Product Offerings
- Comprehensive Document Support

### Design Assistance Services

- Schematic Review
- Placement and Layout Review
- Debugging Assistance Services
- General/Special Reference Design Database

### Thermal Solution Services

- Standard Thermal Solutions
- Customized Thermal Solutions

### Embedded Software Services

- Embedded OS
- BIOS Customization
- Application Library: SUSI (Secure and Unified Smart Interface)

## A Series of Value-Added Services for Carrier Board Development

Advantech COM Design Support Services help customers to reduce the time and work involved with designing new carrier boards. We handle the complexities of technical research and greatly minimize the development risk associated with carrier boards.

## **COM Product & Support Services**

Advantech provides a full range of Computer on Modules including COM-Express, ETX, XTX and COM-Micro to fulfill diverse customer applications. Advantech also serves comprehensive document support to clients for project development.

### **Design Assistance Services**

The Design Assistance Service is created to offer essential help to complete crucial development tasks: schematic review, placement review, debugging and a general/special database of technologies for reference purposes. All services reduce design risks associated with completing customer carrier boards.

### **Thermal Solution Services**

In order to provide quicker and more flexible solutions for customer's thermal designs. Advantech provides thermal solution services including modularized thermal solutions and customized thermal solutions.

### **Embedded Software Services**

Advantech provides embedded software services to customers who integrate Advantech hardware products. Advantech embedded software services include Embedded BIOS services, OS services and API Library iManager. Embedded software services help decrease design effort and project complexity, and accelerate product development.

### **COM Design Support Zone: <http://com.advantech.com/>**

Advantech reserves the right to determine, on a case by case basis, whether or not COM Design Support Services are appropriate.

## **Technical Support and Assistance**

1. Visit the Advantech web site at [www.advantech.com/support](http://www.advantech.com/support) where you can find the latest information about the product.
2. Contact your distributor, sales representative, or Advantech's customer service center for technical support if you need additional assistance. Please have the following information ready before you call:
  - Product name and serial number
  - Description of your peripheral attachments
  - Description of your software (operating system, version, application software, etc.)
  - A complete description of the problem
  - The exact wording of any error messages

---

## Safety Instructions

1. Read these safety instructions carefully.
2. Keep this User Manual for later reference.
3. Disconnect this equipment from any AC outlet before cleaning. Use a damp cloth. Do not use liquid or spray detergents for cleaning.
4. For plug-in equipment, the power outlet socket must be located near the equipment and must be easily accessible.
5. Keep this equipment away from humidity.
6. Put this equipment on a reliable surface during installation. Dropping it or letting it fall may cause damage.
7. The openings on the enclosure are for air convection. Protect the equipment from overheating. **DO NOT COVER THE OPENINGS.**
8. Make sure the voltage of the power source is correct before connecting the equipment to the power outlet.
9. Position the power cord so that people cannot step on it. Do not place anything over the power cord.
10. All cautions and warnings on the equipment should be noted.
11. If the equipment is not used for a long time, disconnect it from the power source to avoid damage by transient overvoltage.
12. Never pour any liquid into an opening. This may cause fire or electrical shock.
13. Never open the equipment. For safety reasons, the equipment should be opened only by qualified service personnel.
14. If one of the following situations arises, get the equipment checked by service personnel:
  - The power cord or plug is damaged.
  - Liquid has penetrated into the equipment.
  - The equipment has been exposed to moisture.
  - The equipment does not work well, or you cannot get it to work according to the user's manual.
  - The equipment has been dropped and damaged.
  - The equipment has obvious signs of breakage.

## Safety Precaution - Static Electricity

Follow these simple precautions to protect yourself from harm and the products from damage.

- To avoid electrical shock, always disconnect the power from your PC chassis before you work on it. Don't touch any components on the CPU card or other cards while the PC is on.
- Disconnect power before making any configuration changes. Electrostatic discharge as you connect a jumper or install a card may damage sensitive electronic components.

## Packing List

Before you begin installing your card, please make sure that the following materials have been shipped:

- 1 SOM-6763 B1 module
- 1 Utility CD (including manual and driver)
- 1 heatspreader 95 x 95 x 11mm

# Contents

<b>Chapter 1</b>	<b>General Information .....</b>	<b>1</b>
1.1	Introduction .....	2
1.2	Specifications .....	2
1.2.1	Standard System On Module functions .....	2
1.2.2	VGA/Flat Panel Interface .....	3
1.2.3	Audio Function .....	3
1.2.4	Ethernet .....	3
1.2.5	Mechanical and Environmental .....	3
<b>Chapter 2</b>	<b>Mechanical Information .....</b>	<b>5</b>
2.1	Connectors .....	6
2.1.1	Board Connector .....	6
2.1.2	Connector List .....	6
	Table 2.1: FAN1 FAN .....	6
2.2	Mechanical .....	7
2.2.1	Jumper and Connector Location .....	7
	Figure 2.1 Board Layout (component side) .....	7
	Figure 2.2 Board Layout (Solder side) .....	7
2.2.2	Board Dimension .....	8
	Figure 2.3 Board Dimension (Component side) .....	8
	Figure 2.4 Board Dimension (Solder side) .....	8
<b>Chapter 3</b>	<b>AMI BIOS .....</b>	<b>9</b>
3.1	Introduction .....	10
	Figure 3.1 Setup program initial screen .....	10
3.2	Entering Setup .....	11
3.2.1	Main Setup .....	11
	Figure 3.2 Main setup screen .....	11
3.2.2	Advanced BIOS Features Setup .....	12
	Figure 3.3 Advanced BIOS features setup screen .....	12
	Figure 3.4 CPU Configuration Setting .....	13
	Figure 3.5 IDE Configuration .....	14
	Figure 3.6 Floppy Configuration .....	15
	Figure 3.7 Super I/O Configuration .....	16
	Figure 3.8 ACPI Settings .....	17
	Figure 3.9 General ACPI Configuration .....	17
	Figure 3.10 Advanced ACPI Configuration .....	18
	Figure 3.11 Chipset ACPI Configuration .....	19
	Figure 3.12 Advanced ACPI Configuration .....	20
	Figure 3.13 Event Log Configuration .....	21
	Figure 3.14 MPS Configuration .....	22
	Figure 3.15 SMBIOS Configuration .....	22
	Figure 3.16 South Bridge ACPI Configuration .....	23
	Figure 3.17 USB Mass storage Device Configuration .....	24
	Figure 3.18 Hardware Health Configuration .....	25
3.2.3	Advanced PCI/PnP Settings .....	26
	Figure 3.19 PCI/PNP Setup .....	26
3.2.4	Boot Settings .....	27
	Figure 3.20 Boot Setup Utility .....	27
	Figure 3.21 Boot Setting Configuration .....	28
3.2.5	Security Setup .....	29



	Figure 3.22 Password Configuration .....	29
3.2.6	Advanced Chipset Settings.....	30
	Figure 3.23 Advanced Chipset Settings .....	30
	Figure 3.24 North Bridge Configuration .....	30
	Figure 3.25 Video Function Configuration .....	31
	Figure 3.26 South Bridge Configuration .....	32
3.2.7	Exit Option .....	33
	Figure 3.27 Exit Option .....	33
<b>Chapter 4</b>	<b>S/W Introduction &amp; Installation.....</b>	<b>35</b>
4.1	S/W Introduction .....	36
4.2	Driver Installation .....	36
4.2.1	Windows XP professional .....	36
4.2.2	Other OS.....	36
<b>Appendix A</b>	<b>Watchdog Timer.....</b>	<b>37</b>
A.1	Programming the Watchdog Timer .....	38
<b>Appendix B</b>	<b>Programming GPIO.....</b>	<b>39</b>
B.1	GPIO Register.....	40
<b>Appendix C</b>	<b>System Assignments.....</b>	<b>41</b>
C.1	System I/O Ports .....	42
	Table C.1: System I/O ports.....	42
C.2	DMA Channel Assignments .....	43
	Table C.2: DMA Channel Assignments .....	43
C.3	Interrupt Assignments .....	44
	Table C.3: Interrupt assignments.....	44
C.4	System Memory Map .....	45
	Table C.4: System Memory Map .....	45



# Chapter 1

## General Information

This chapter gives background information on the SOM-6763 B1 CPU System on Module.

Sections include:

- Introduction
- Specification

## 1.1 Introduction

SOM-6763 B1 is an embedded COM-Express Compact COM.0 R2.0 Type 2 CPU module that fully complies with the PCI Industrial Computer Manufacturers PICMG COM Express standard. The new CPU module supports Intel N455 and D525 processors with ICH8M chipset which supports Intel Embedded Gen3.5 + GFX Core, MPEG2 Decode in HW, PCI Express and SATA interfaces. In a basic form factor of 95mm x 95mm, the SOM-6763 B1 provides a scalable high performance and easy to integrate solution for customers' applications by utilizing a plug-in CPU module on an application-specific customer solution board. The SOM-6763 B1 with advanced I/O capacity incorporates serial differential signaling technologies such as PCI Express, Serial ATA, USB 2.0, LVDS, and HD Audio interfaces. SOM-6763 B1 offers design partners more choices for their own applications needing higher computing speeds while maintaining a compact form factor.

SOM-6763 B1 complies with the "Green Function" standard and supports Doze, Standby and Suspend modes. The small size (95 mm x 95 mm) and use of one high capacity connector based on the proven COM-Express Compact form factor, allow the COM-Micro modules to be easily and securely mounted onto a customized solution board or our standard SOM-DB5700 development board.

The SOM-6763 B1 is a highly integrated multimedia COM module that combines audio, video, and network functions. The Intel N455 and D525 processors provide excellent performance, and there's a single channel LVDS interface for middle size TFT LCD displays, DDR3 memory up to 2 GB (N455) or 4 GB (D525), and high definition audio interface (AC97/HD Audio).

## 1.2 Specifications

### 1.2.1 Standard System On Module functions

- **CPU:**
  - Onboard Intel® Atom N455 processor
  - Onboard Intel® Atom D525 processor  
(For detailed CPU support information, please contact your sales representative)
- **BIOS:** AMI 16 MB Flash BIOS
- **Chipset:** Intel® ICH8-M Chipset
- **Cache memory:**
  - Intel® Atom N455 processor integrated 512 KB L2 cache
  - Intel® Atom D525 processor integrated 1 MB L2 cache
- **System memory:**
  - 204-pin SODIMM supports 667MHz (N455)/ 800MHz (D525) DDR3 memory only
  - Up to 2GB memory at Intel® Atom N455 processor
  - Up to 4GB memory at Intel® Atom D525 processor
- **Power management:** Supports power saving modes including Normal / Standby / Suspend modes. ACPI 2.0 compliant
- **SATA interface:** 3 SATAII Channels
- **Watchdog timer:** Multi-stage watchdog timer programmable by Advantech iManager (For more information, refer to iManager & Software API User Manual)

- **USB interface:** Support 8 USB 2.0 ports
- **Expansion Interface:** Supports LPC, 5 PCIe x1 (1 PCIe x4 or 1 PCIe x2 option), 4 PCI masters

### 1.2.2 VGA/Flat Panel Interface

- **Chipset:** Intel ICH8-M, Gen 3.5 DX9, MPEG2 decode controller
- **Display type:**
  - Dual display support for VGA and LVDS
  - Supports 24-bit single channel LVDS interface
- **Display mode:**
  - CRT Mode: Supports up to 1400 x 1050 (N455); 2048 x 1536 (D525)
  - LCD Mode: Supports up to 1366 x 768

### 1.2.3 Audio Function

- **Audio interface:** Intel high definition audio interface

### 1.2.4 Ethernet

- **Chipset:** 1000Mbps: Intel 82567V Gigabit Ethernet. Base on IEEE 10BASE-T, 100BASE-TX and 1000BASE-T standard.

### 1.2.5 Mechanical and Environmental

- **Dimensions:** COM-Micro form-factor, 95 mm x 95 mm (3.74" x 3.74")
- **Power supply voltage:** +12 V power only (+5 VSB is needed for ACPI and ATX power)
- **Power requirement:**
  - SOM-6763N (1 GB DDRII 667): +12 V @ 0.93 A
  - SOM-6763D (1 GB DDRII 800): +12 V @ 1.47 A
- **Operating temperature:** 0 ~ 60° C (32 ~ 140° F)
- **Operating humidity:** 0% ~ 90% relative humidity, non-condensing
- **Weight:** 0.103 Kg (weight of total package)



# Chapter 2

## Mechanical Information

This chapter gives mechanical and connector information on the SOM-6763 B1 CPU System on Module.

Sections include:

- Connector Information
- Mechanical

## 2.1 Connectors

### 2.1.1 Board Connector

There are two connectors at the rear side of SOM-6763 B1 for connecting to carrier board.

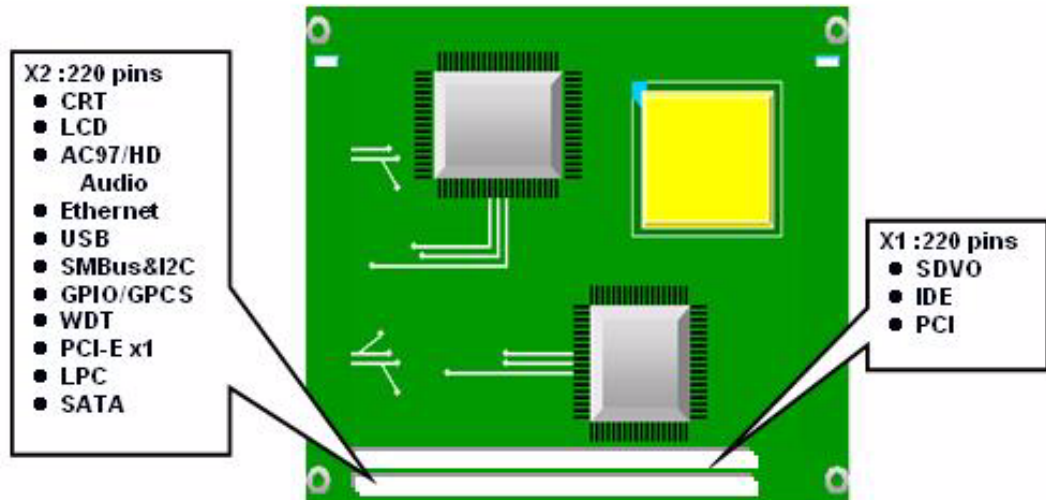

Pin Assignments for X1/X2 connector

Please refer to *Advantech\_COM\_Express\_Design Guide*, Chapter 2.

You can download Advantech\_COM\_Express\_Design Guide from <http://com.advantech.com/>.

### 2.1.2 Connector List

**Table 2.1: FAN1 FAN**

<b>FAN1</b>	Fan
<b>Description</b>	Wafer 2.0 mm 3P 90D(M)DIP 2001-WR-03-LF W/Lock
<b>Pin</b>	<b>Pin Name</b>
1	Fan Tacho-Input
2	Fan Out
3	GND

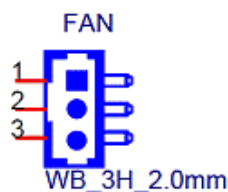

## 2.2 Mechanical

### 2.2.1 Jumper and Connector Location

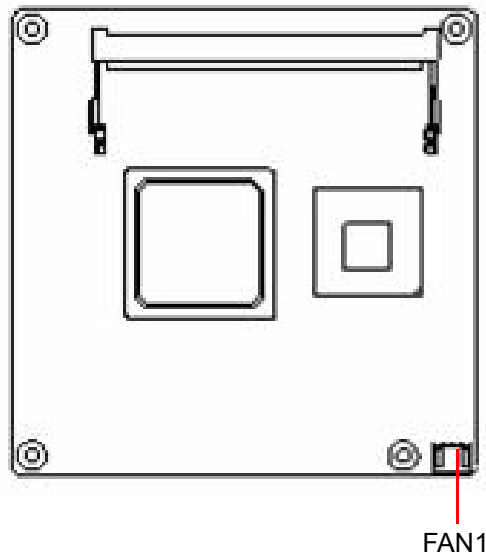

Figure 2.1 Board Layout (component side)

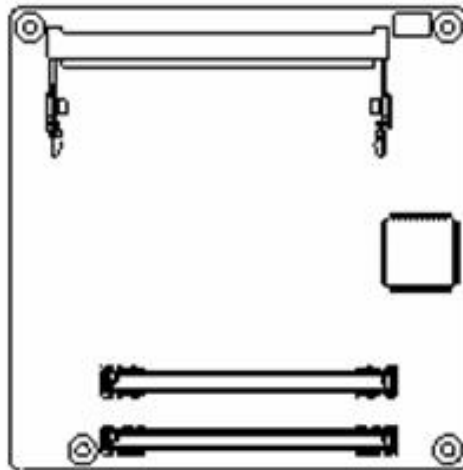
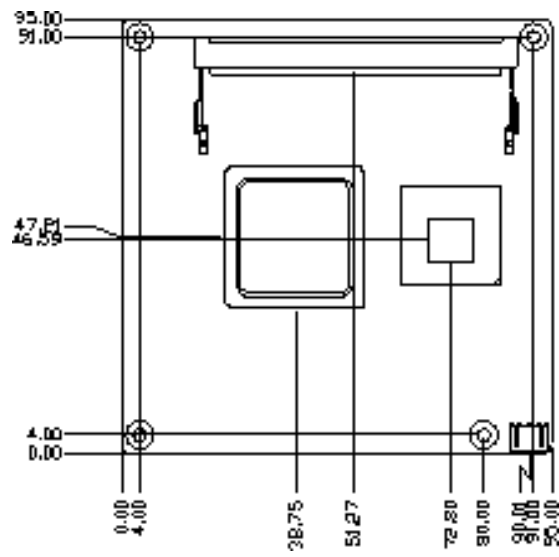

Figure 2.2 Board Layout (Solder side)



## 2.2.2 Board Dimension



(unit: mm)

Figure 2.3 Board Dimension (Component side)

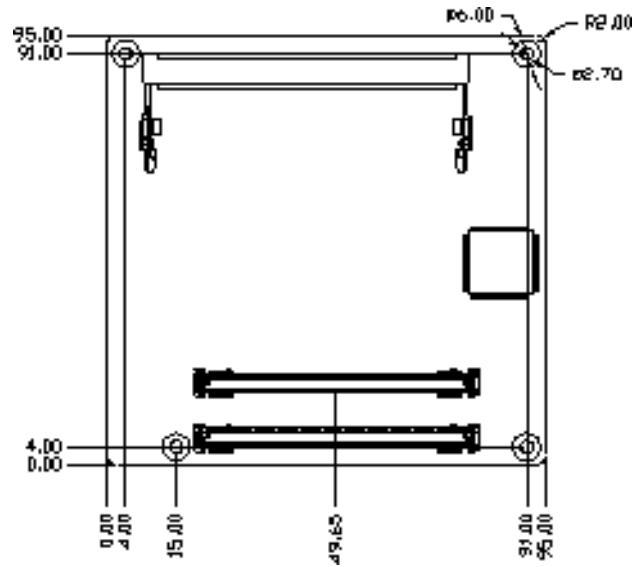

(unit: mm)

Figure 2.4 Board Dimension (Solder side)

# Chapter 3

## AMI BIOS

Sections include:

- Introduction
- Entering Setup

## 3.1 Introduction

AMIBIOS has been integrated into many motherboards for over a decade. With the AMIBIOS Setup program, users can modify BIOS settings and control various system features. This chapter describes the basic navigation of the SOM-6763 BIOS setup screens.

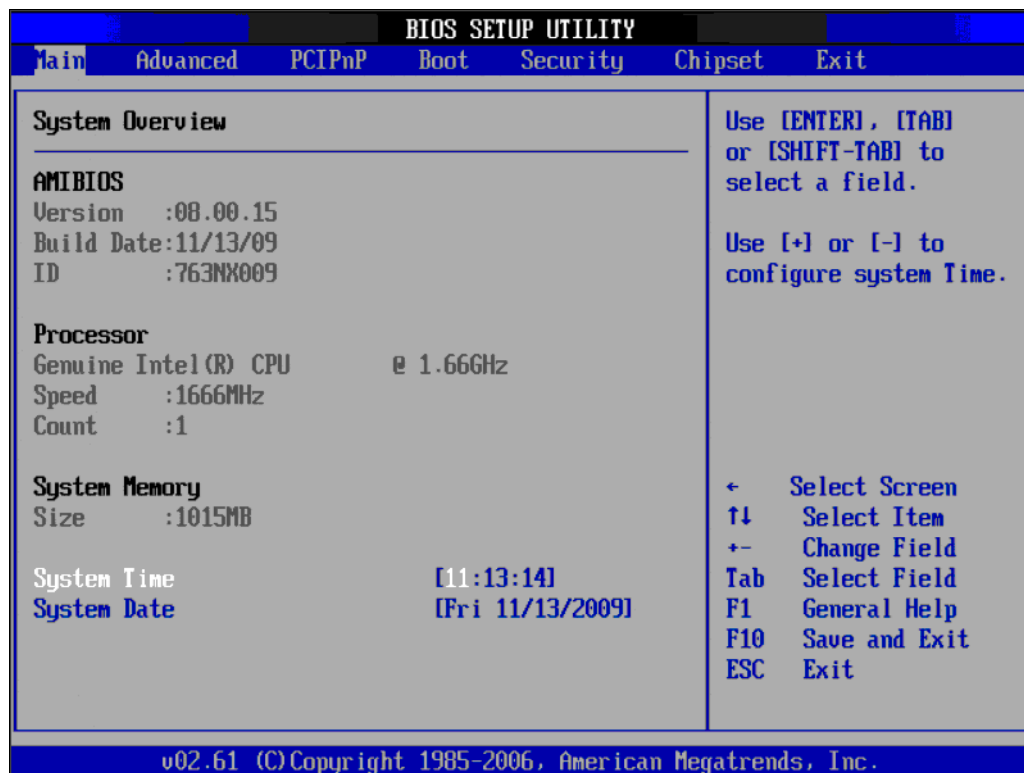

Figure 3.1 Setup program initial screen

AMI's BIOS ROM has a built-in Setup program that allows users to modify the basic system configuration. This information is stored in battery-backed CMOS so it retains the Setup information when the power is turned off.

## 3.2 Entering Setup

The BIOS is immediately activated when you first power on the computer. The BIOS reads the system information contained in the CMOS and begins the process of checking the system and configuring it. When it finishes, the BIOS will seek an operating system on one of the disks and then launch and turn control over to the operating system. While the BIOS is in control, the Setup program can be activated in one of two ways:

1. By pressing <Del> immediately after switching the system on, or:
2. By pressing the <Del> key when the following message appears briefly at the bottom of the screen during the POST (Power On Self-Test):  
Press DEL to enter SETUP.

If the message disappears before you respond and you still want to enter Setup, restart the system to try again by turning it OFF then ON or pressing the Reset button on the system case. You may also restart by simultaneously pressing Ctrl, Alt, and Delete keys. If you do not press the keys at the correct time and the system does not boot, the following error message will be displayed:

PRESS F1 TO CONTINUE, DEL TO ENTER SETUP

### 3.2.1 Main Setup

When users first enter the BIOS Setup Utility, users will enter the Main setup screen. Users can always return to the Main setup screen by selecting the Main tab. There are two Main Setup options. They are described in this section. The Main BIOS Setup screen is shown below.



Figure 3.2 Main setup screen

The Main BIOS setup screen has two main frames. The left frame displays all the options that can be configured. Grayed-out options cannot be configured; options in blue can. The right frame displays the key legend.

Above the key legend is an area reserved for a text message. When an option is selected in the left frame, it is highlighted in white. Often a text message will accompany it.

### 3.2.1.1 System time / System date

Use this option to change the system time and date. Highlight System Time or System Date using the <Arrow> keys. Enter new values through the keyboard. Press the <Tab> key or the <Arrow> keys to move between fields. The date must be entered in MM/DD/YY format. The time must be entered in HH:MM:SS format.

### 3.2.2 Advanced BIOS Features Setup

Select the Advanced tab from the SOM-6763 setup screen to enter the Advanced BIOS Setup screen. Users can select any item in the left frame of the screen, such as CPU Configuration, to go to the sub menu for that item. Users can display an Advanced BIOS Setup option by highlighting it using the <Arrow> keys. All Advanced BIOS Setup options are described in this section. The Advanced BIOS Setup screens are shown below. The sub menus are described on the following pages.

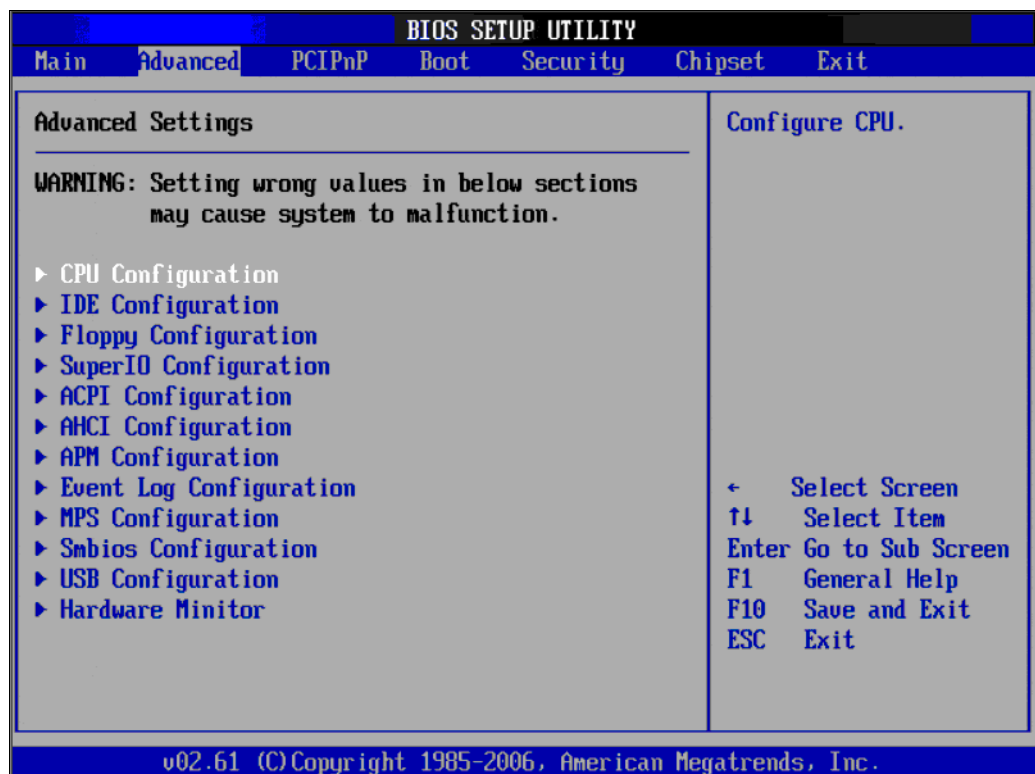

Figure 3.3 Advanced BIOS features setup screen

### 3.2.2.1 CPU Configuration

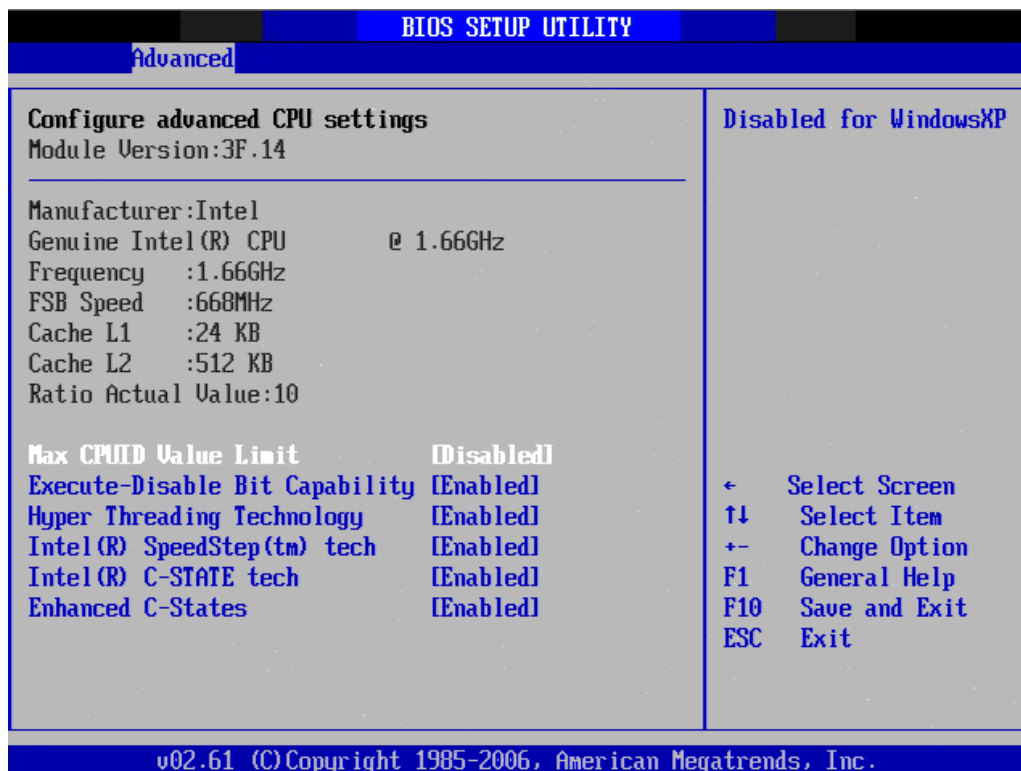

Figure 3.4 CPU Configuration Setting

- **Max CPUID Value Limit**  
This item allows users to limit the maximum value of CPUID.
- **Execute-Disable Bit Capability**  
This item allows users to enable or disable the No-Execution page protection technology.
- **Hyper Threading Technology**  
This item allows users to enable or disable Intel® Hyper Threading technology.
- **Intel SpeedStep**  
CPU runs at its default speed if disabled; CPU speed is controlled by the operating system if enabled.
- **Intel C-STATE**  
This item allows the CPU to save more power in idle mode.
- **Enhanced C-States**  
Enable / Disable Intel® C-STATE technology.

### 3.2.2.2 IDE Configuration

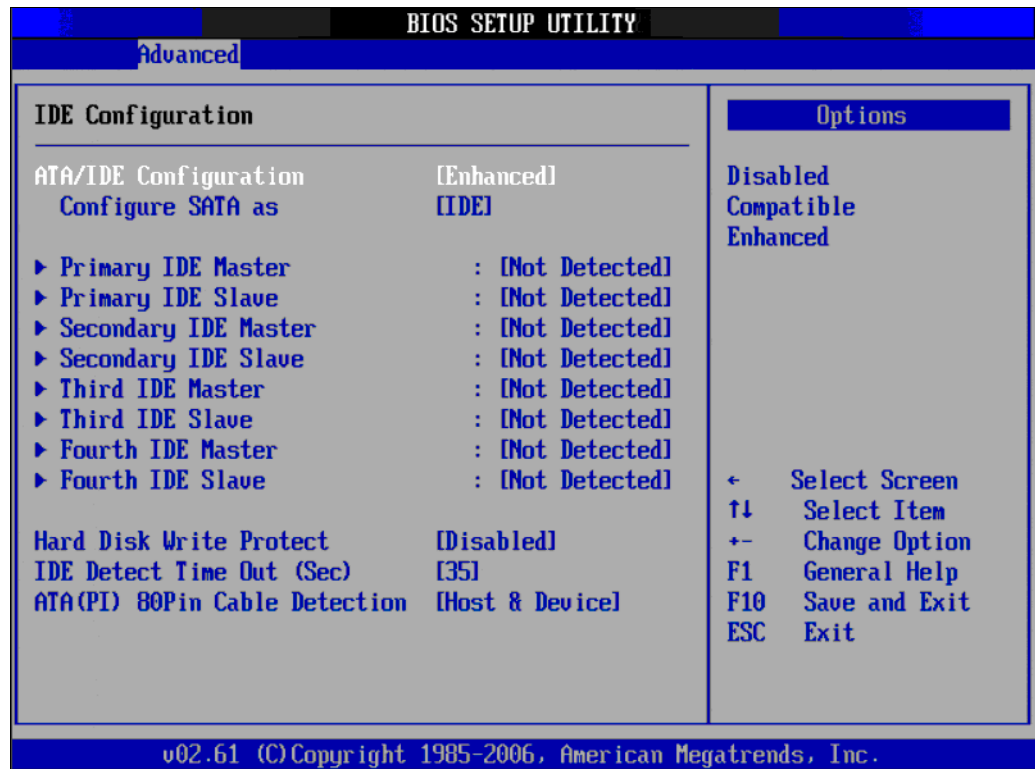

Figure 3.5 IDE Configuration

- **ATA/IDE Configuration**

This item allows users to select Disabled / Compatible / Enhanced.
- **Legacy IDE Channels**

When set to Enhanced mode, users can select IDE or AHCI mode. When selecting Compatible mode, users can select "SATA only", "SATA Primary, PATA Secondary" or "PATA only".
- **Primary/Secondary/Third/Fourth IDE Master/Slave**

BIOS auto detects the presence of IDE device, and displays the status of auto detection of IDE device.

  - **Type:** Select the type of SATA driver.[Not Installed][Auto][CD/DVD][ARMD]
  - **LBA/Large Mode:** Enables or Disables the LBA mode.
  - **Block (Multi-Sector Transfer):** Enables or disables data multi-sectors transfers.
  - **PIO Mode:** Select the operating mode of PIO.
  - **DMA Mode:** Select the operating mode of DMA.
  - **S.M.A.R.T.:** Select the smart monitoring, analysis, and reporting technology.
  - **32Bit Data Transfer:** Enables or disables 32-bit data transfer.
- **Hard Disk Write Protect**

Disable/Enable device write protection. This will be effective only if a device is accessed through BIOS.
- **IDE Detect Time Out (Sec)**

This item allows users to select the time out value for detecting ATA/ATAPI device(s).



- **ATA(PI) 80Pin Cable Detection**

This item allows users to select the way to detect an IDE 80 pin cable.

### 3.2.2.3 Floppy Configuration

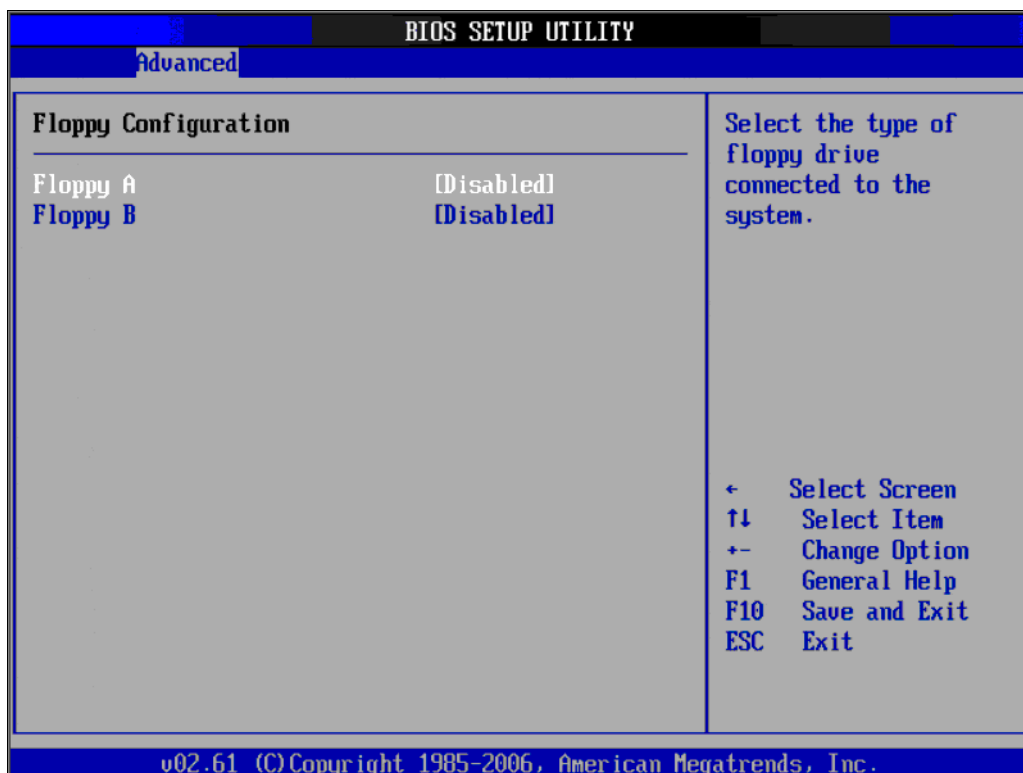

**Figure 3.6 Floppy Configuration**

- **Floppy A/B**

Select the type of floppy drive, if any are connected to the system. It is recommended to disable the floppy driver during installation if no floppy drive is connected.

### 3.2.2.4 Super I/O Configuration

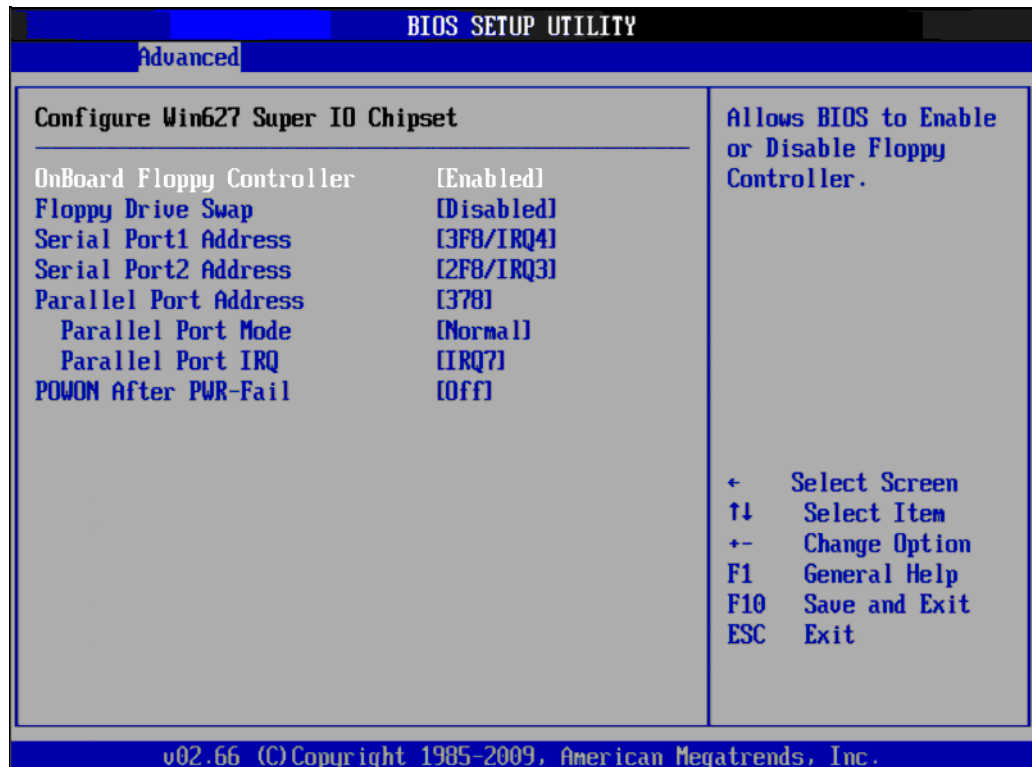

Figure 3.7 Super I/O Configuration

- **Onboard Floppy Controller**  
This item allows users to enable or disable the onboard floppy controller.
- **Floppy Drive Swap**  
This item allows users to enable or disable the floppy swap function.
- **Serial Port1 / Port2 address**  
This item allows users to select the base addresses and IRQs of serial port1 and port2.
- **Parallel Port Address**  
This item allows users to select the base address of the parallel port.
- **Parallel Port Mode**  
This item allows users to select the mode of the parallel port.
- **Parallel Port IRQ**  
This item allows users to select the IRQ of the parallel port.
- **POWON After PWR-Fail**  
This item allows users to select off, on and former status.

### 3.2.2.5 ACPI Settings

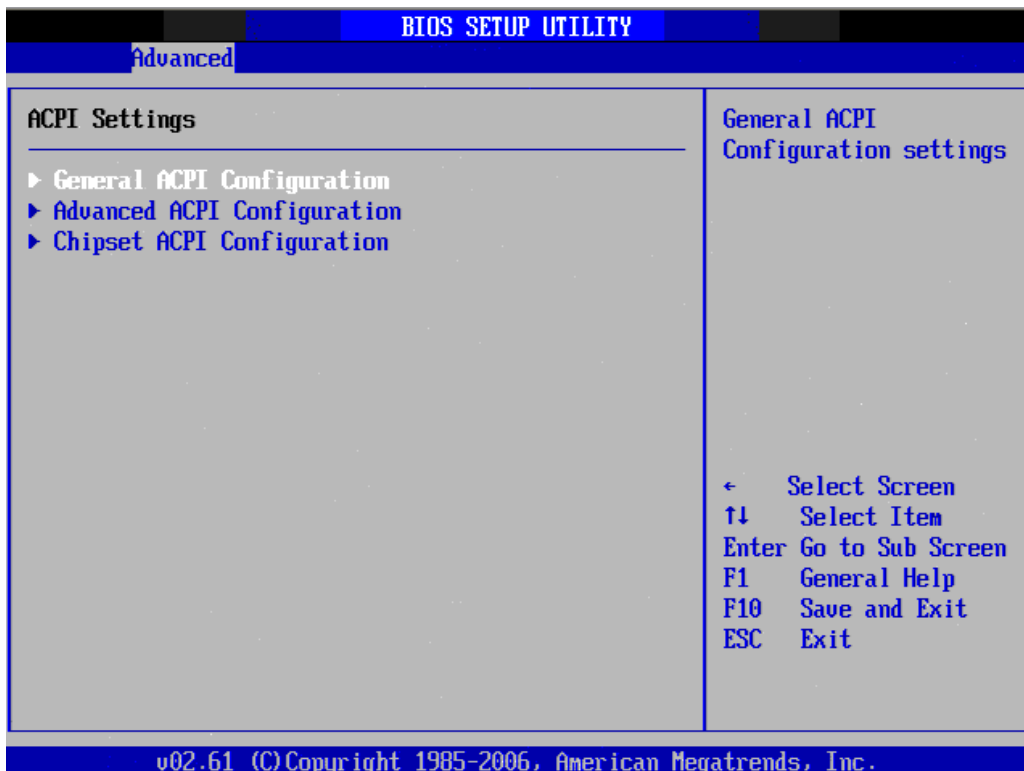

Figure 3.8 ACPI Settings

#### ■ General ACPI Configuration

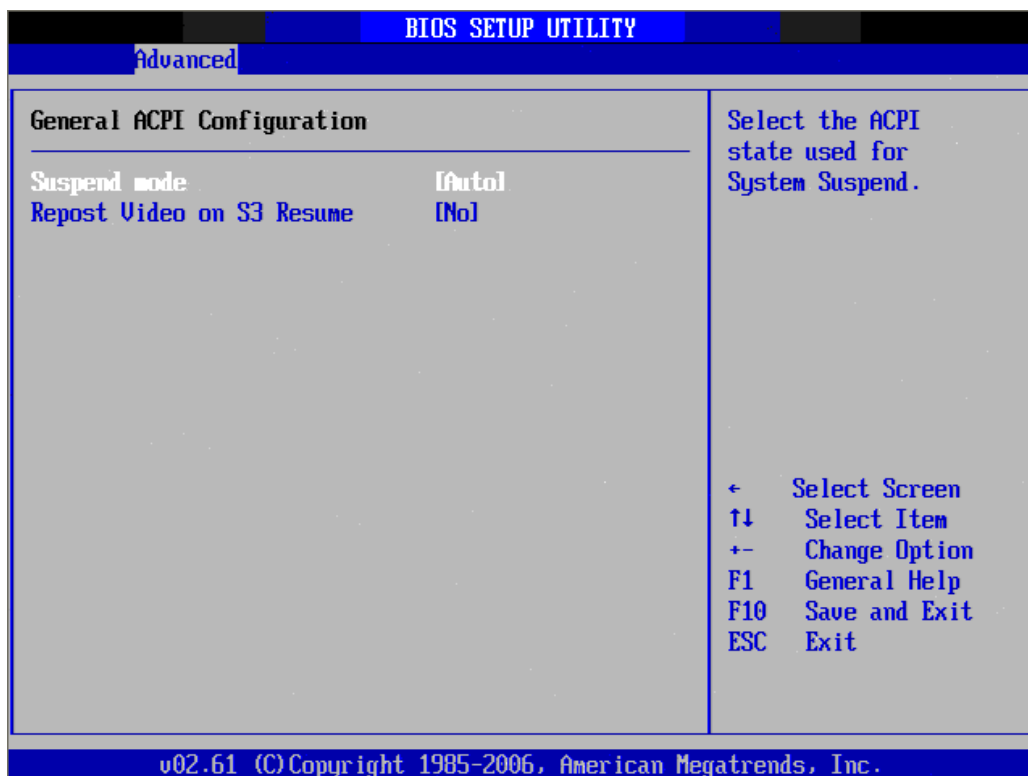

Figure 3.9 General ACPI Configuration

#### – Suspend mode

Select the ACPI state used for system suspend.

- **Report Video on S3 Resume**

This item allows users to invoke VGA BIOS POST on S3/STR resume.

- **Advanced ACPI Configuration**

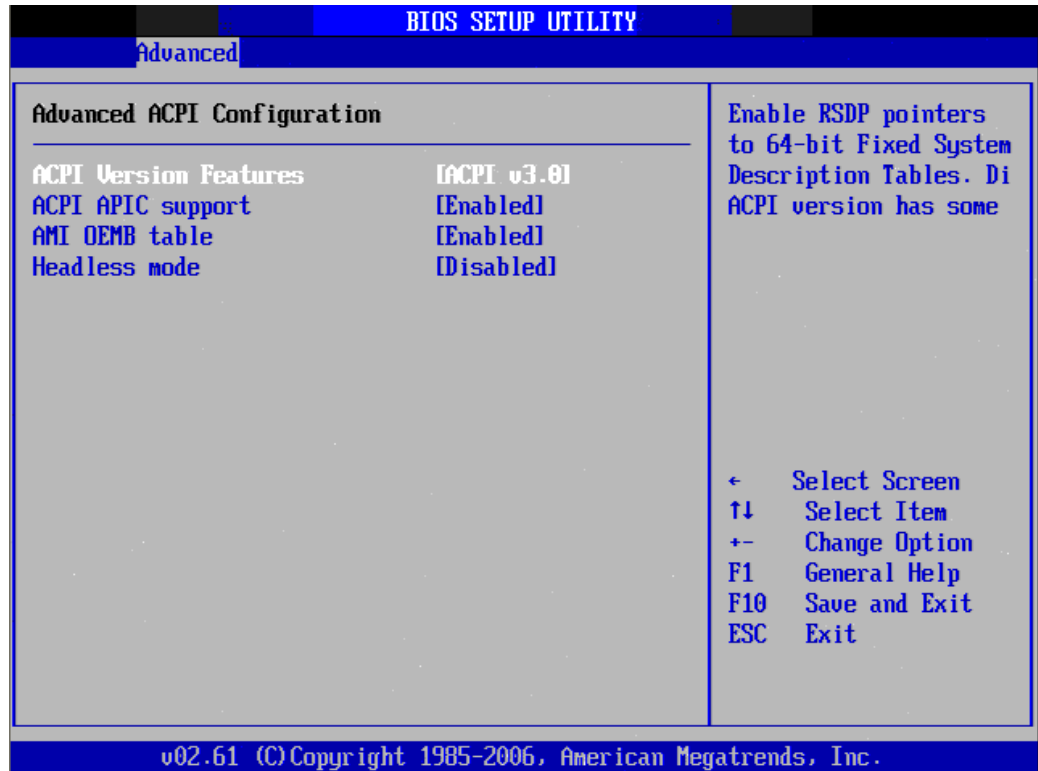

**Figure 3.10 Advanced ACPI Configuration**

- **ACPI Version Features**

This item allows users to enable RSDP pointers to 64-bit fixed system description tables.

- **ACPI APIC support**

Include APIC table pointer to RSDT pointer list.

- **AMI OEMB table**

Include OEMB table pointer to R(x)SDT pointer lists.

- **Headless mode**

Enable / Disable Headless operation mode through ACPI.

## ■ Chipset ACPI Configuration

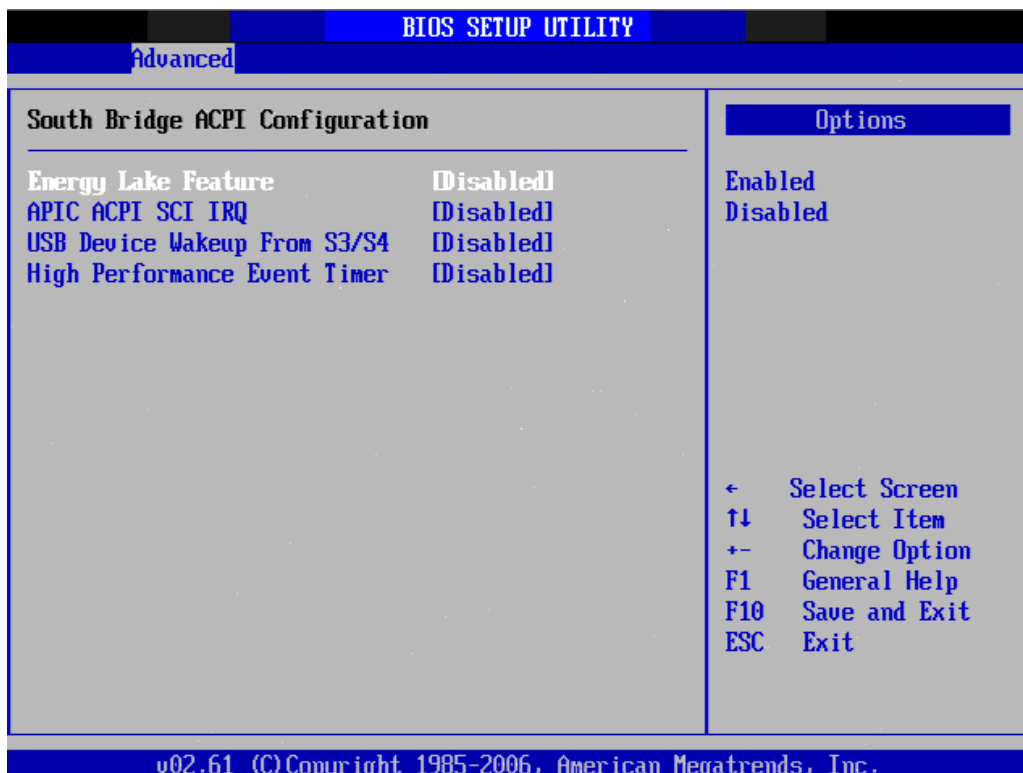

Figure 3.11 Chipset ACPI Configuration

- **Energy Lake Feature**  
This item allows users to configure Intel's Energy Lake power management technology.
- **APIC ACPI SCI IRQ**  
Enable/Disable APIC ACPI SCI IRQ.
- **USB Device Wakeup From S3/S4**  
Enable/Disable USB Device Wakeup from S3/S4.
- **High Performance Event Timer**  
Enable/Disable High performance Event timer.

### 3.2.2.6 AHCI Configuration

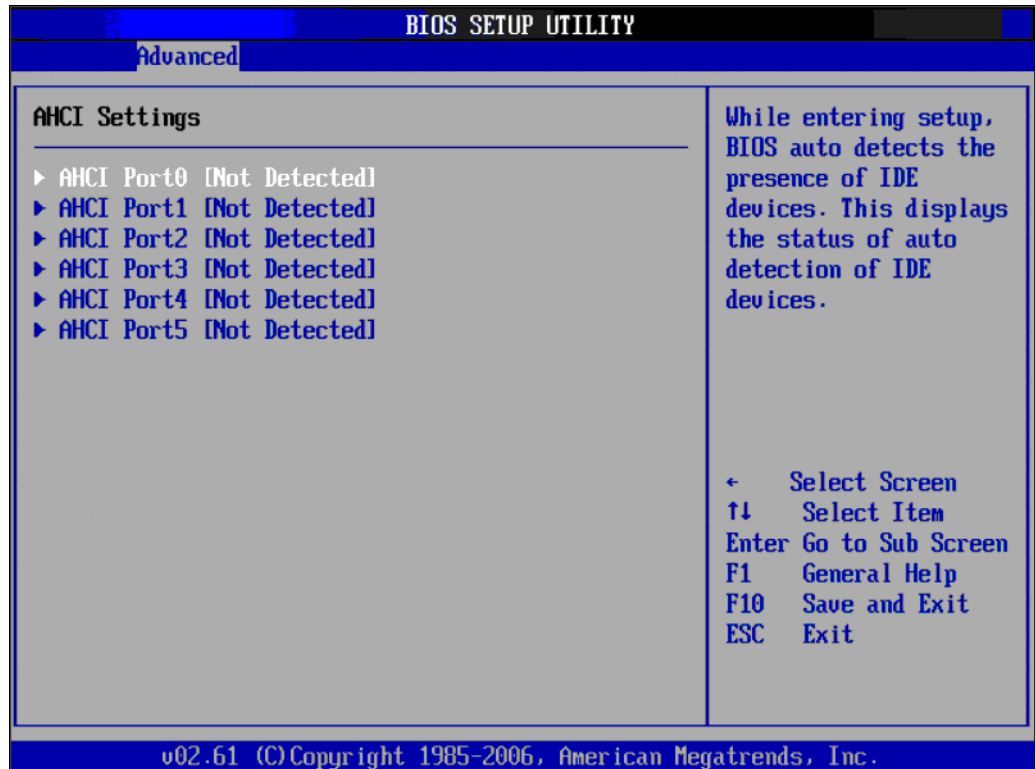

Figure 3.12 Advanced ACPI Configuration

- **AHCI Port0 / Port1/ Port2/ Port3/ Port4/ Port5**  
While entering setup, BIOS auto detects the presence of IDE devices and displays the status of detected IDE devices.

### 3.2.2.7 Event Log Configuration

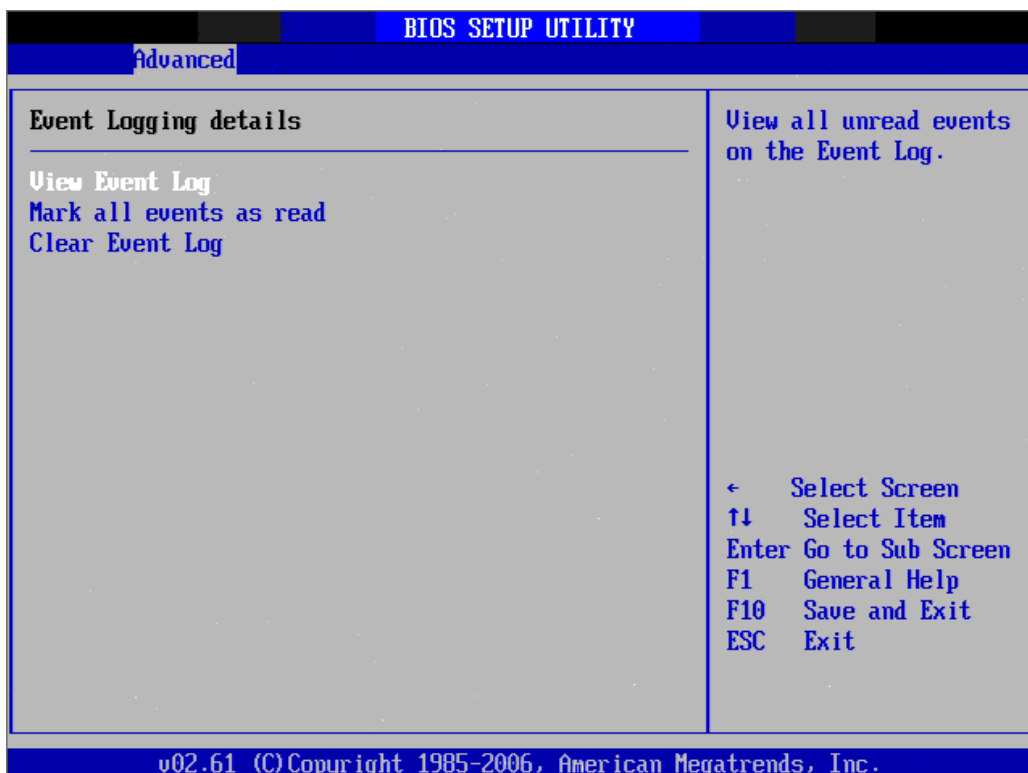

Figure 3.13 Event Log Configuration

- **View Event Log**  
View all unread events on the event Log.
- **Mark all Events as Read**  
Mark all unread events as read.
- **Clear Event Log**  
Discard all events in the event Log.



### 3.2.2.8 MPS Configuration

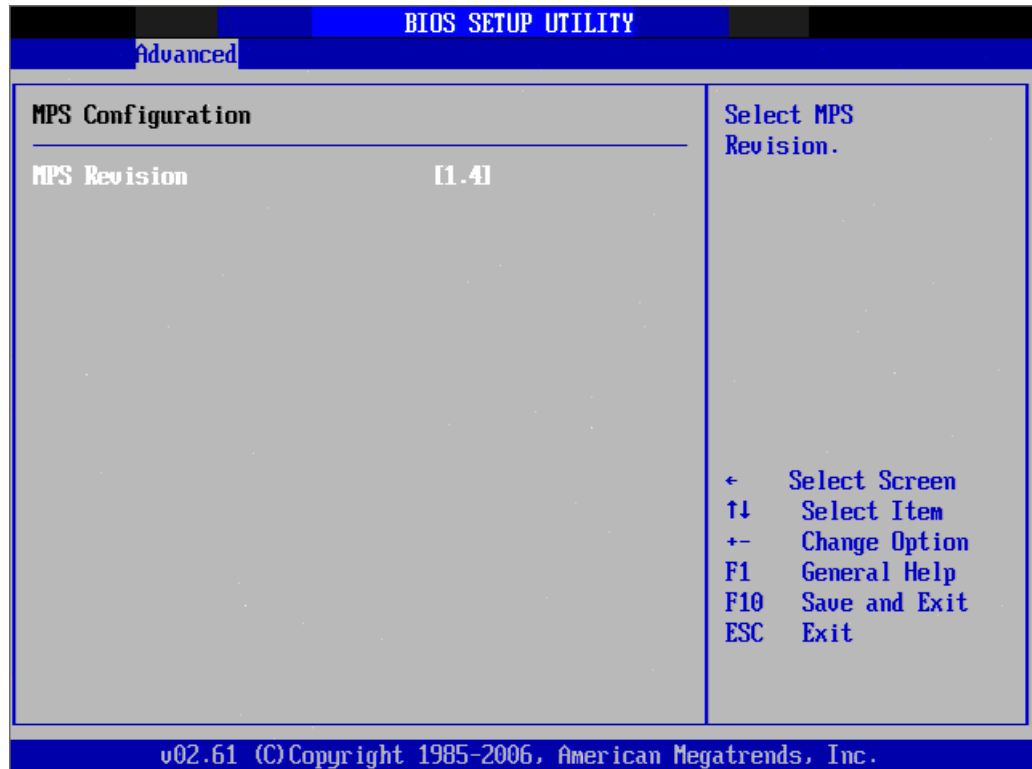

Figure 3.14 MPS Configuration

- **MPS Revision**

This item allows users to select MPS reversion.

### 3.2.2.9 SMBIOS Configuration

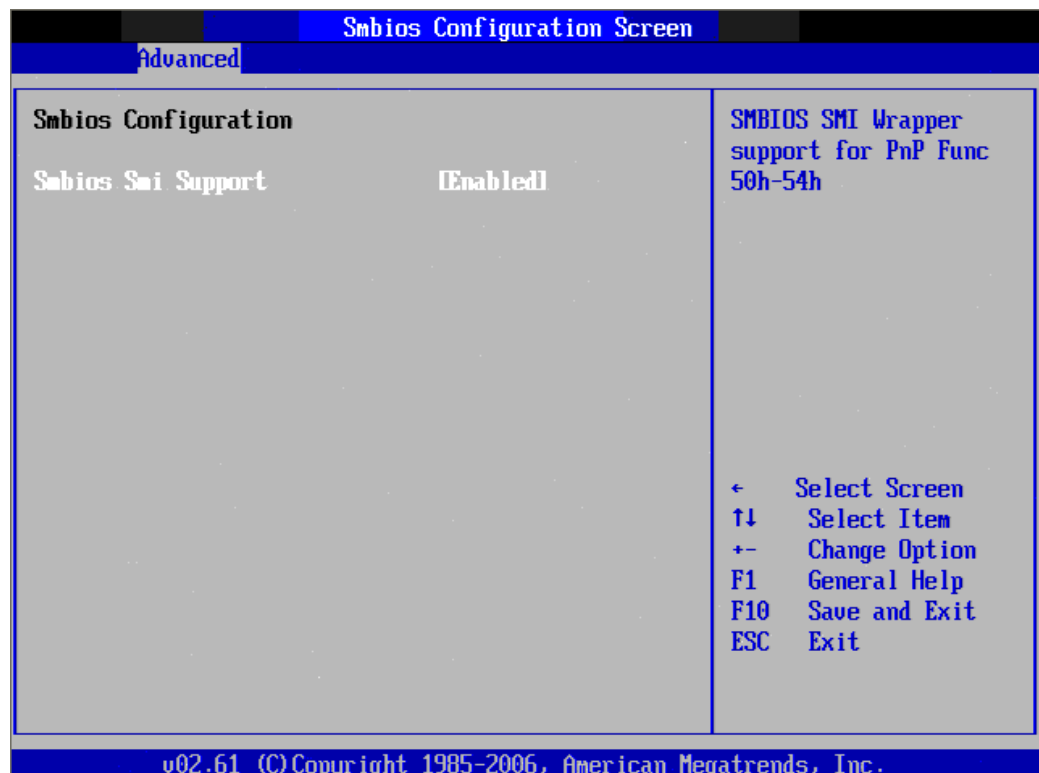

Figure 3.15 SMBIOS Configuration

- **SMBIOS SMI Support**  
SMBIOS SMI wrapper support for PnP function 50h-54h.

### 3.2.2.10 USB Configuration

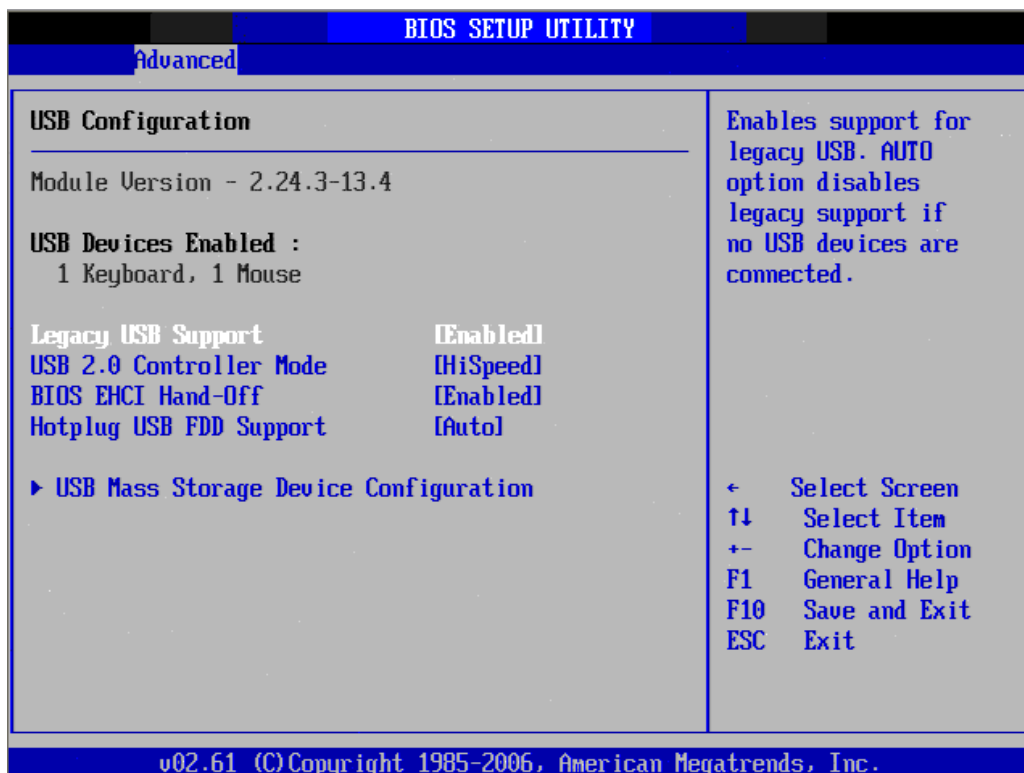

Figure 3.16 South Bridge ACPI Configuration

- **Legacy USB Support**  
Enables support for legacy USB. Auto option disables legacy support if no USB devices are connected.
- **USB 2.0 Controller Mode**  
This item allows users to select HiSpeed (480 Mbps) or FullSpeed (12 Mbps).
- **BIOS EHCI Hand-Off**  
This is a work around for the OS without EHCI hand-off support. The EHCI ownership change should claim by EHCI driver.
- **Hotplug USB FDD Support**  
A dummy FDD device is created that will be associated with the hot-plugged FDD later. Auto option creates this dummy device only if there is no USB FDD present.

## ■ USB Mass Storage Device Configuration



Figure 3.17 USB Mass storage Device Configuration

- **USB Mass Storage Reset Delay**  
Number of seconds POST waits for the USB mass storage device after start unit command.
- **Emulation Type**  
If Auto, USB devices less than 530MB will be emulated as a Floppy and the remaining as hard drives. Force FDD option can be used to force an FDD formatted drive to boot as a FDD (Ex. ZIP drive).

## 3.2.2.11 Hardware Health Configuration



Figure 3.18 Hardware Health Configuration

- **Power Saving**  
This item allows users to set the board's power saving mode when off.
- **EC WDT Use IRQ**  
This item allows users to set the IRQ number of the iManager watchdog.
- **ACPI Critical Shutdown Temp**  
This item allows users to set the value of the CPU shutdown temperature in ACPI OS.
- **Temperature, Voltage and FAN speed show**  
CPU Temperature  
5 VS / 12 V / VBAT  
FAN speed

### 3.2.3 Advanced PCI/PnP Settings

Select the PCI/PnP tab from the SOM-6763 B1 setup screen to enter the Plug and Play BIOS Setup screen. You can display a Plug and Play BIOS Setup option by highlighting it using the <Arrow> keys. All Plug and Play BIOS Setup options are described in this section. The Plug and Play BIOS Setup screen is shown below.

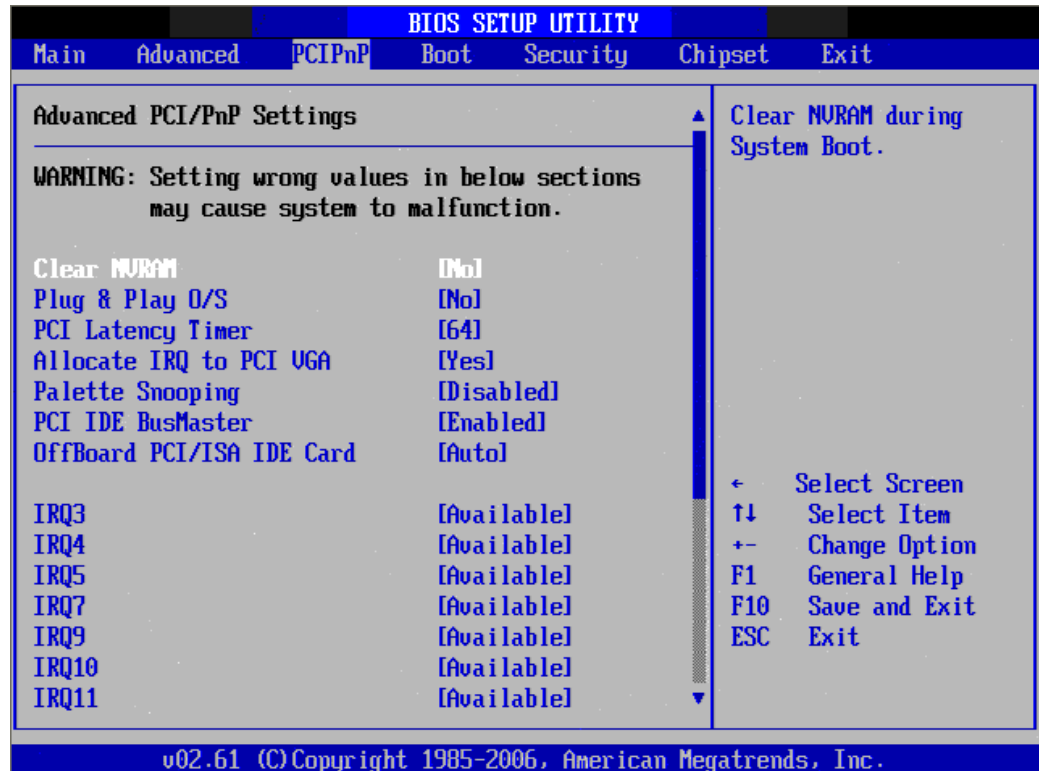

Figure 3.19 PCI/PNP Setup

#### 3.2.3.1 Clear NVRAM

Set this value to force the BIOS to clear the Non-Volatile Random Access Memory (NVRAM). The Optimal and Fail-Safe default setting is No.

#### 3.2.3.2 Plug & Play O/S

When set to No, the BIOS configures all devices in the system. If set to "Yes", and the OS supports Plug & Play, then rebooting the system is not required after the OS finishes configuration of the plug and play devices.

#### 3.2.3.3 PCI Latency Timer

Value in units of PCI clocks for PCI device latency timer register.

#### 3.2.3.4 Allocate IRQ to PCI VGA

When set to Yes will assign IRQ to PCI VGA card if the card requests an IRQ. When set to No the BIOS will not assign an IRQ to PCI VGA card even if the card requests it.

#### 3.2.3.5 Palette Snooping

This item is designed to solve problems caused by some non-standard VGA cards.

#### 3.2.3.6 PCI IDE BusMaster

When set to enable BIOS, it uses PCI bus mastering for reading/writing to IDE drives.

**3.2.3.7 OffBoard PCI/ISA IDE Card**

Some PCI IDE cards may require this to be set to the PCI slot number that is holding the card. When set to Auto, it will works for most PCI IDE cards.

**3.2.3.8 IRQ3 / 4 / 5 / 7 / 9 / 10 / 11**

This item allows users respectively assign an interruptive type for IRQ-3, 4, 5, 7, 9, 10, 11.

**3.2.3.9 DMA Channel0 / 1 / 3 / 5 / 6 / 7**

When set to Available will specify DMA is available to be used by PCI/PnP devices. When set to Reserved will specify DMA will be reserved for use by legacy ISA devices.

**3.2.3.10 Reserved Memory Size**

This item allows users to reserve the size of memory block for legacy ISA devices.

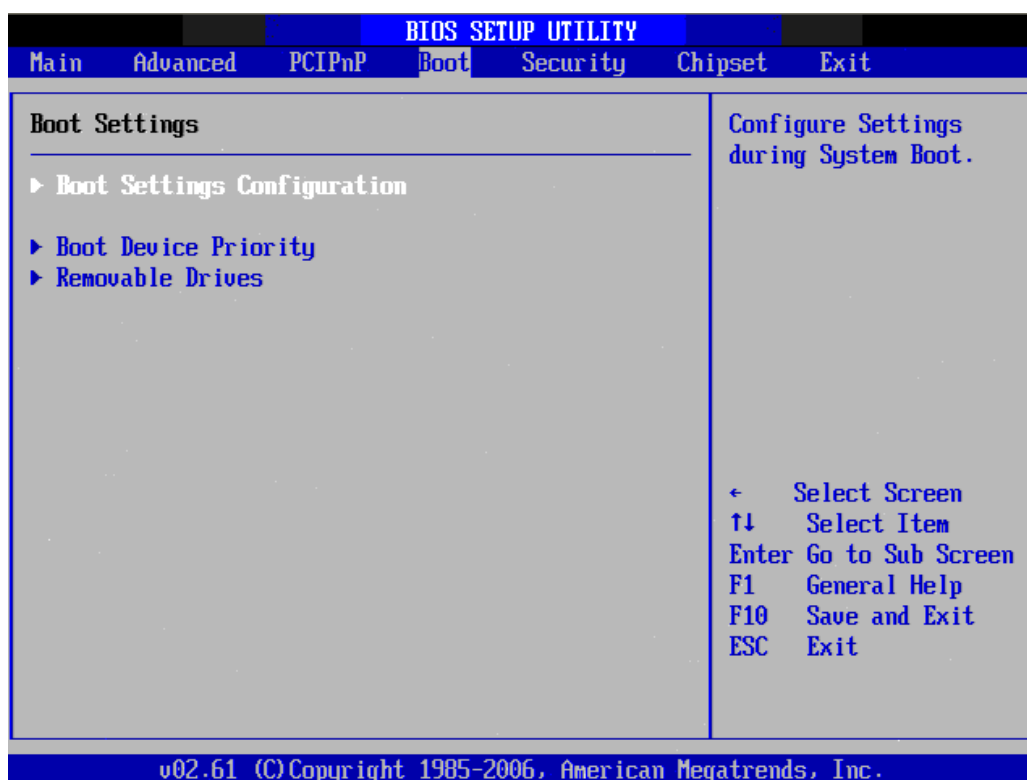
**3.2.4 Boot Settings**

**Figure 3.20 Boot Setup Utility**

### 3.2.4.1 Boot Settings Configuration



Figure 3.21 Boot Setting Configuration

- **Quick Boot**  
This item allows BIOS to skip certain tests while booting. This will decrease the time needed to boot the system.
- **Quiet Boot**  
If this option is set to Disabled, the BIOS displays normal POST messages. If Enabled, an OEM Logo is shown instead of POST messages.
- **AddOn ROM Display Mode**  
Set display mode for option ROM.
- **Bootup Num-Lock**  
Select the Power-on state for Numlock.
- **PS/2 Mouse Support**  
Select support for PS/2 Mouse.
- **Wait For "F1" If Error**  
Wait for the F1 key to be pressed if an error occurs.
- **Hit "DEL" Message Display**  
Displays - Press DEL to run Setup in POST.
- **Interrupt 19 Capture**  
This item allows optional ROM BIOS host adaptors to capture interrupt 19.
- **Bootsafe Function**  
This item allows users to enable or disable bootsafe function.



## 3.2.5 Security Setup



**Figure 3.22 Password Configuration**

Select Security Setup from the SOM-6763 Setup main BIOS setup menu. All Security Setup options, such as password protection and virus protection are described in this section. To access the sub menu for the following items, select the item and press <Enter>:

### 3.2.5.1 Change Supervisor / User Password

Select this option and press <ENTER> to access the sub menu, and then type in the password.

### 3.2.5.2 Boot Sector Virus Protection

The boot sector virus protection will warn if any program tries to write to the boot sector.

## 3.2.6 Advanced Chipset Settings



Figure 3.23 Advanced Chipset Settings

### 3.2.6.1 North Bridge Chipset Configuration

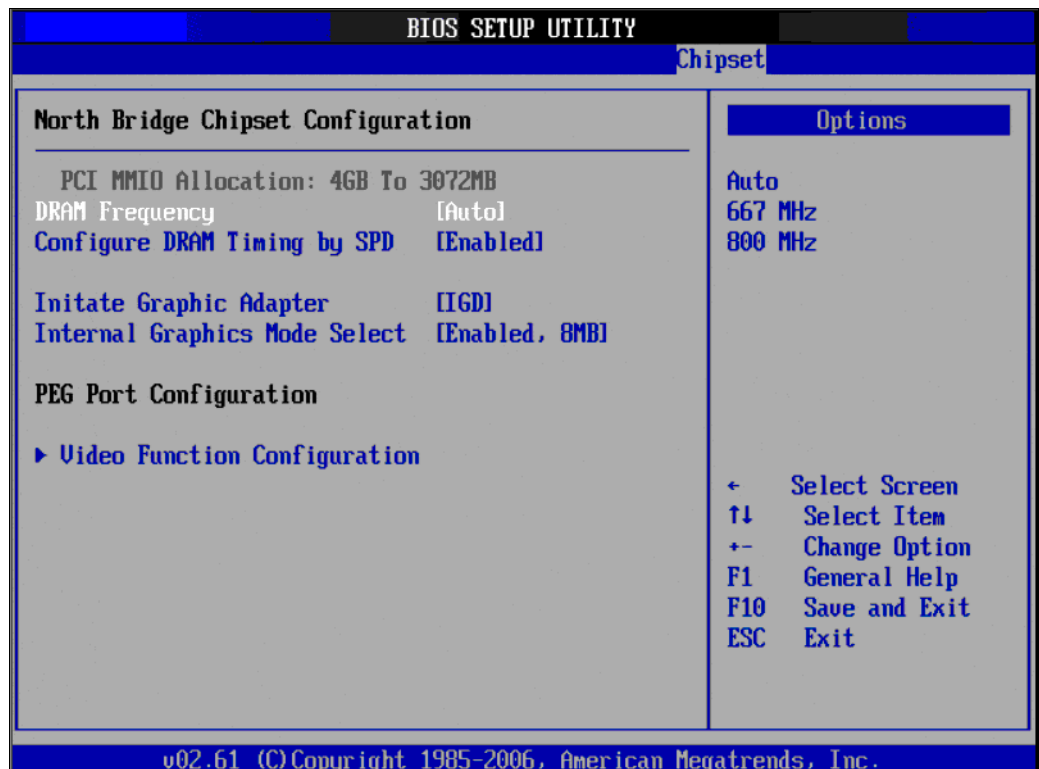

Figure 3.24 North Bridge Configuration

#### ■ DRAM Frequency

- This item allows users to change DRAM frequency manually.
- **Configure DRAM Timing by SPD**  
This item allows users to enable or disable detect by DRAM SPD.
- **Memory Hole**  
This item allows users to free 15 MB-16 MB of memory size for some ISA devices.
- **Initiate Graphic Adapter**  
This item allows users to select which graphics controller to use as the primary boot device.
- **Internal Graphics Mode Select**  
Select the amount of system memory can be used by the Internal graphics device.
- **Video Function Configuration**

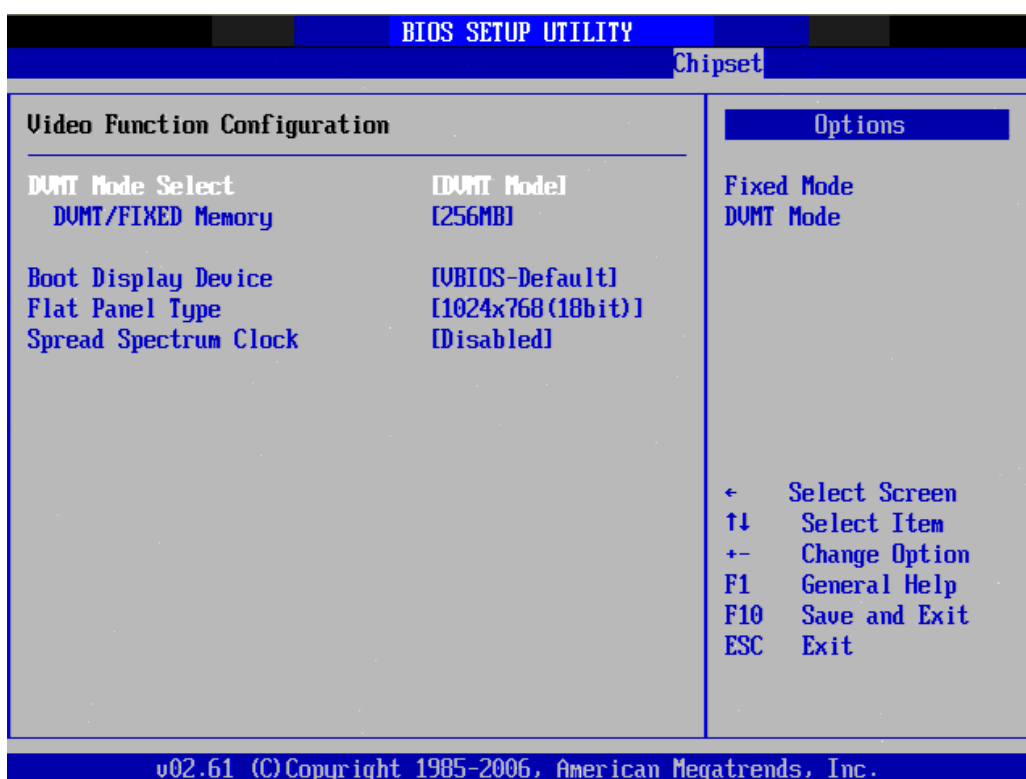

Figure 3.25 Video Function Configuration

- **DVMT Mode Select**  
Displays the active system memory mode.
- **DVMT/FIXED Memory**  
Specify the amount of DVMT / FIXED system memory to allocate for video memory.
- **Boot Display Device**  
Select boot display device at post stage.
- **Flat Panel Type**  
This item allows users to select panel resolution.
- **Spread Spectrum Clock**  
This item allows users to enable or disable spread spectrum clock.

### 3.2.6.2 South Bridge Chipset Configuration



Figure 3.26 South Bridge Configuration

- **USB Functions**  
Disabled, 2 USB Ports, 4 USB Ports, 6 USB Ports or 8 USB Ports.
- **USB 2.0 Controller**  
Enables or disables the USB 2.0 controller.
- **GbE controller**  
Enables or disables the GbE controller.
- **GbE LAN Boot**  
Enables or disables GbE LAN boot.
- **GbE Wake Up From S5**  
Enables or disables GbE LAN wake up from S5 function.
- **HDA Controller**  
Enables or disables the HDA controller.
- **SMBUS Controller**  
Enables or disables the SMBUS controller.
- **SLP\_S4# Min. Assertion Width**  
This item allows users to set a delay of sorts.
- **PCIE Port 0 / 1 / 2 / 3 / 4**  
This item allows users to configure PCIE port
- **PCIE High Priority Port**  
This item allows users to set the highest priority PCIE port.
- **PCIE Port 0 / 1 / 2 / 3 / 4 IOxAPIC**  
This item allows users to enable or disable PCIE port's IOxAPIC.

## 3.2.7 Exit Option

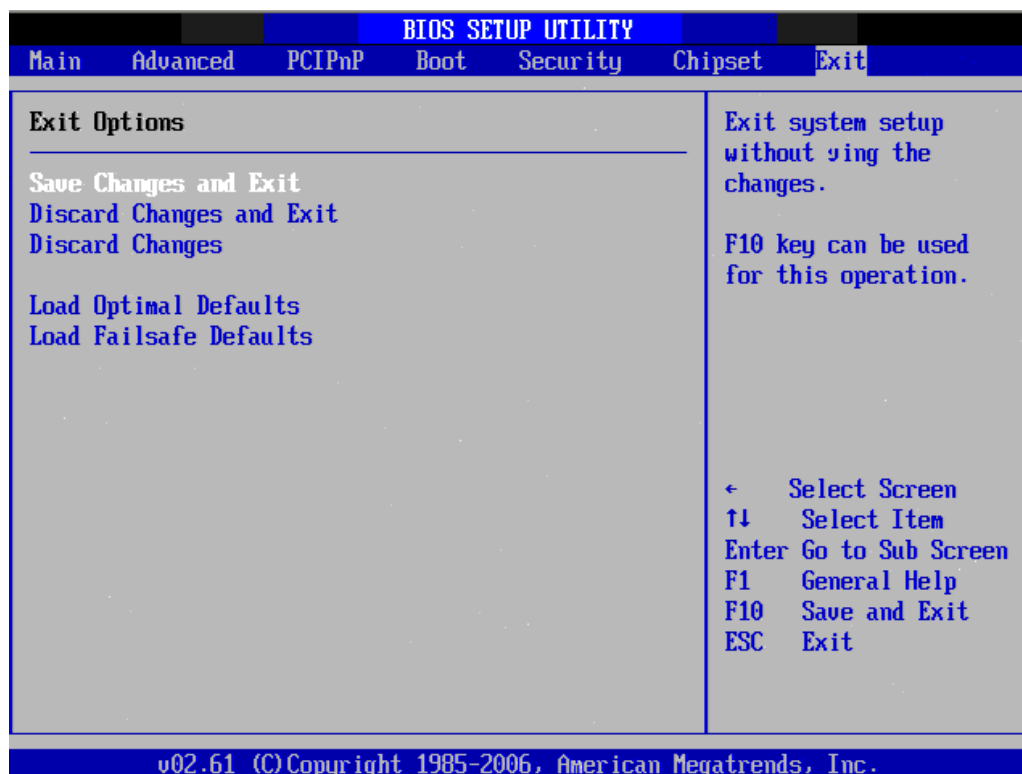

Figure 3.27 Exit Option

### 3.2.7.1 Save Changes and Exit

When users have completed system configuration, select this option to save changes, exit BIOS setup menu and reboot the computer for all system configuration parameters to take effect .

1. Select Exit Saving Changes from the Exit menu and press <Enter>. The following message appears: Save Configuration Changes and Exit Now? [Ok] [Cancel]
2. Select Ok or cancel.

### 3.2.7.2 Discard Changes and Exit

Select this option to quit Setup without making any permanent changes to the system configuration.

1. Select Exit Discarding Changes from the Exit menu and press <Enter>. The following message appears: Discard Changes and Exit Setup Now? [Ok] [Cancel]
2. Select Ok to discard changes and exit. Discard Changes
3. Select Discard Changes from the Exit menu and press <Enter>.

### 3.2.7.3 Load Optimal Defaults

The SOM-6763 automatically configures all setup items to optimal settings when users select this option. Optimal Defaults are designed for maximum system performance, but may not work best for all computer applications. In particular, do not use the Optimal Defaults if the user's computer is experiencing system configuration problems. Select Load Optimal Defaults from the Exit menu and press <Enter>.

#### Load Fail-Safe Defaults

The SOM-6763 automatically configures all setup options to fail-safe settings when users select this option. Fail-Safe Defaults are designed for maximum system stabil-

---

ity, but not maximum performance. Select Fail-Safe Defaults if the user's computer is experiencing system configuration problems.

1. Select Load Fail-Safe Defaults from the Exit menu and press <Enter>. The following message appears: Load Fail-Safe Defaults? [OK] [Cancel]
2. Select OK to load Fail-Safe defaults.

# Chapter 4

## S/W Introduction & Installation

Sections include:

- S/W Introduction
- Driver Installation

---

## 4.1 S/W Introduction

The mission of Advantech Embedded Software Services is to "Enhance quality of life with Advantech platforms and Microsoft Windows embedded technology." We enable Windows Embedded software products on Advantech platforms to more effectively support the embedded computing community. Customers are freed from the hassle of dealing with multiple vendors (Hardware suppliers, System integrators, Embedded OS distributor) for projects. Our goal is to make Windows Embedded Software solutions easily and widely available to the embedded computing community.

Advantech also tries to assist customers to enhance product reliability, reduce the trouble of system integration and simplify platform migration. That is why SOM-6763 B1 proudly introduces the adoption of iManager. It helps customer to monitor the system and reduces the effort when issues occur. For more information, please refer to iManager & Software API User Manual @

<http://support.advantech.com.tw/Support/DownloadSearchByProduct.aspx?keyword=SOM-6763+B1>

## 4.2 Driver Installation

The Intel Chipset Software Installation (CSI) utility installs the Windows INF files that outline to the operating system how the chipset components will be configured.

### 4.2.1 Windows XP professional

To install the drivers please just insert the CD into CD-ROM, select the drivers that you want to install, then run .exe (setup) file under each chipset folder and follow Driver Setup instructions to complete the installation.

### 4.2.2 Other OS

To install the drivers for Other Windows OS or Linux, please contact local FAE for help.



# Appendix **A**

## Watchdog Timer

This appendix gives you the information about the watchdog timer programming on the SOM-6763 B1 CPU System on Module.

Sections include:

- Watchdog Timer Programming

---

## A.1 Programming the Watchdog Timer

SOM-6763 B1 allows user to control the behavior of the Watchdog Timer through iManager.

Trigger Event	Note
IRQ	IRQ interrupt. IRQ7, 9, or 11 needed to be set in BIOS.
NMI	N/A
SCI	Power button event
Power Off	Support
H/W Restart	Support
External WDT	N/A

For details, please refer to *iManager & Software API User Manual*.

# Appendix **B**

## Programming GPIO

This Appendix gives the illustration of the General Purpose Input and Output pin setting.

Sections include:

- System I/O ports

---

## B.1 GPIO Register

GPIO Register is programmable using iManager:

GPIO Byte Mapping	H/W Pin Name
bit0	GPO0
bit1	GPO1
bit2	GPO2
bit3	GPO3
bit4	GPI0
bit5	GPI1
bit6	GPI2
bit7	GPI3

For details, please refer to *iManager & Software API User Manual*.

# Appendix **C**

## System Assignments

This appendix gives you information about the system resource allocation on the SOM-6763 B1 CPU System on Module.

Sections include:

- System I/O ports
- DMA Channel Assignments
- Interrupt Assignments
- 1st MB Memory Map

## C.1 System I/O Ports

**Table C.1: System I/O ports**

Addr.range (Hex)	Device
0000 - 000F	Direct memory access controller
0000 - 0CF7	PCI bus
0010 - 001F	Motherboard resources
0020 - 0021	Programmable interrupt controller
0022 - 003F	Motherboard resources
0040 - 0043	System timer
0044 - 005F	Motherboard resources
0060 - 0060	Standard 101/102-Key or Microsoft Natural PS/2 Keyboard
0061 - 0061	System speaker
0062 - 0062	Microsoft ACPI-Compliant Embedded Controller
0063 - 0063	Motherboard resources
0064 - 0064	Standard 101/102-Key or Microsoft Natural PS/2 Keyboard
0065 - 0065	Motherboard resources
0066 - 0066	Microsoft ACPI-Compliant Embedded Controller
0067 - 006F	Motherboard resources
0070 - 0071	System CMOS/real time clock
0072 - 007F	Motherboard resources
0080 - 0080	Motherboard resources
0081 - 0083	Direct memory access controller
0084 - 0086	Motherboard resources
0087 - 0087	Direct memory access controller
0088 - 0088	Motherboard resources
0089 - 008B	Direct memory access controller
008C - 008E	Motherboard resources
008F - 008F	Direct memory access controller
0090 - 009F	Motherboard resources
00A0 - 00A1	Programmable interrupt controller
00A2 - 00BF	Motherboard resources
00C0 - 00DF	Direct memory access controller
00E0 - 00EF	Motherboard resources
00F0 - 00FF	Numeric data processor
01F0 - 01F7	Primary IDE Channel
0274 - 0277	ISAPNP Read Data Port
0279 - 0279	ISAPNP Read Data Port
0378 - 037F	Parallel port (LPT1) N455 CPU only
03B0 - 03BB	Intel(R) Graphic Media Accelerator 3150
03C0 - 03DF	Intel(R) Graphic Media Accelerator 3150
03F6 - 03F6	Primary IDE Channel
03F8 - 03FF	Communications Port (COM1)
0400 - 041F	Intel(R) ICH8 Family SMBus Controller – 283E
04D0 - 04D1	Motherboard resources

0500 - 053F	Motherboard resources
0800 - 087F	Motherboard resources
0A00 - 0A0F	Motherboard resources
0A79 - 0A79	ISAPNP Read Data Port
0D00 - FFFF	PCI bus
D080 - D087	Intel(R) Graphic Media Accelerator 3150
D400 - D41F	Intel 82567V-3 Gigabit Network Connection
D480 - D49F	Standard Universal PCI to USB Host Controller
D800 - D81F	Intel ICH8 Family USB Universal Host Controller - 2832
D880 - D89F	Intel ICH8 Family USB Universal Host Controller - 2831
DC00 - DC1F	Intel ICH8 Family USB Universal Host Controller - 2830
E080 - E08F	Intel ICH8M 3 port Serial ATA Storage Controller - 2828
E400 - E40F	Intel ICH8M 3 port Serial ATA Storage Controller - 2828
E480 - E483	Intel ICH8M 3 port Serial ATA Storage Controller - 2828
E800 - E807	Intel ICH8M 3 port Serial ATA Storage Controller - 2828
E880 - E883	Intel ICH8M 3 port Serial ATA Storage Controller - 2828
EC00 - EC07	Intel ICH8M 3 port Serial ATA Storage Controller - 2828
FFA0 - FFAF	Intel ICH8M Ultra ATA Storage Controller - 2850

## C.2 DMA Channel Assignments

**Table C.2: DMA Channel Assignments**

Channel	Function
0	Available
1	Available
2	Available
3	Available
4	Direct memory access controller
5	Available
6	Available
7	Available

## C.3 Interrupt Assignments

**Table C.3: Interrupt assignments**

<b>Interrupt#</b>	<b>Interrupt source</b>
NMI	Parity error detected
IRQ 0	System timer
IRQ 1	Standard 101/102-Key or Microsoft Natural PS/2 Keyboard
IRQ2	Available
IRQ3	Available
IRQ 4	Communications Port (COM1)
IRQ 5	Available
IRQ 6	Available
IRQ 7	Available
IRQ 8	System CMOS/real time clock
IRQ 9	Microsoft ACPI-Compliant System
IRQ 10	Available
IRQ 11	Available
IRQ 12	PS/2 Compatible Mouse
IRQ 13	Numeric data processor
IRQ 14	Primary IDE Channel
IRQ 15	Available
IRQ 16	Intel(R) Graphic Media Accelerator 3150
IRQ 16	Standard Universal PCI to USB Host Controller
IRQ 18	Intel(R) ICH8 Family USB Universal Host Controller – 2832*
IRQ 18	Intel(R) ICH8M 3 port Serial ATA Host Controller – 2828
IRQ 19	Intel(R) ICH8 Family USB Universal Host Controller – 2831*
IRQ 21	Microsoft UAA Bus Driver for High Definition Audio
IRQ 23	Intel(R) 82567V-3 Gigabit Network Connection*
IRQ 23	Intel ICH8 Family USB Universal Host Controller – 2830*
IRQ 23	Intel ICH8 Family USB2 Universal Host Controller - 2836*

\*USB and Ethernet IRQ is automatically set by the system



## C.4 System Memory Map

**Table C.4: System Memory Map**

Addr. range (Hex)	Device
00000000 - 0009FFFF	System board
000A0000 - 000BFFFF	Intel(R) Graphic Media Accelerator 3150
000A0000 - 000BFFFF	PCI Bus
000C0000 - 000CFFFF	System board
000D0000 - 000DFFFF	PCI bus
000E0000 - 000FFFFFF	System board
00100000 - 7F6FFFFFF	System board
7F700000 - DFFFFFFF	PCI Bus
D0000000 - DFFFFFFF	Intel(R) Graphic Media Accelerator 3150
E0000000 - EFFFFFFF	Motherboard resource
F0000000 - FED8FFFF	PCI Bus
FE980000 - FE9FFFFF	Intel(R) Graphic Media Accelerator 3150
FEA00000 - FEAFFFFF	Intel(R) Graphic Media Accelerator 3150
FEB00000 - FEB7FFFF	Intel(R) Graphic Media Accelerator 3150
FEBC0000 - FEBDFFFF	Intel 82567V-3 Gigabit Network Connection
FEBF8000 - FEBFBFFF	Microsoft UAA Bus Driver for High Definition Audio
FEBFE000 - FEBFEFFF	Intel 82567V-3 Gigabit Network Connection
FEBFF800 - FEBFFBFF	Intel ICH8 Family USB2 Enhanced Host Controller - 2836
FEBFFC00 - FEBFFCFF	Intel ICH8 Family SMBus Controller - 283E
FEC00000 - FEC00FFF	Motherboard resources
FED00000 - FED003FF	HPET (High Precision Event Timer)
FED14000 - FED19FFF	System board
FED1C000 - FED1FFFF	Motherboard resources
FED20000 - FED3FFFF	Motherboard resources
FED40000 - FED8FFFF	Motherboard resources
FED90000 - FED93FFF	System board
FED90000 - FFFFFFFF	System board
FEE00000 - FEE00FFF	Motherboard resources
FFB00000 - FFBFFFFF	Intel 82802 Firmware Hub Device
FFC00000 - FFEFFFFFF	Motherboard resources
FFF00000 - FFFFFFFF	Intel 82802 Firmware Hub Device

**ADVANTECH**

*Enabling an Intelligent Planet*

**[www.advantech.com](http://www.advantech.com)**

Please verify specifications before quoting. This guide is intended for reference purposes only.

All product specifications are subject to change without notice.

No part of this publication may be reproduced in any form or by any means, electronic, photocopying, recording or otherwise, without prior written permission of the publisher.

All brand and product names are trademarks or registered trademarks of their respective companies.

© Advantech Co., Ltd. 2011