

300-mA Ultra Low-Noise LDO Regulator With Discharge Option

FEATURES

- Ultra Low Dropout—300 mV at 300-mA Load
- Ultra Low Noise—30 μV_{RMS} (10-Hz to 100-kHz)
- Shutdown Control
- 130- μA Ground Current at 300-mA Load
- 1.5% Guaranteed Output Voltage Accuracy
- 400-mA Peak Output Current Capability
- Uses Low ESR Ceramic Capacitors
- Fast Start-Up (50 μs)
- Fast Line and Load Transient Response ($\leq 30 \mu\text{s}$)
- 1- μA Maximum Shutdown Current
- Output Current Limit
- Reverse Battery Protection
- Built-in Short Circuit and Thermal Protection



- Output, Auto-Discharge In Shutdown Mode
- Fixed 1.2, 1.8, 2.5, 2.6, 2.8, 3.0, 3.3, 5.0-V Output Voltage Options
- MLP33-5 PowerPAK® Package

APPLICATIONS

- Cellular Phones, Wireless Handsets
- Noise-Sensitive Electronic Systems, Laptop and Palmtop Computers
- PDAs
- Pagers
- Digital Cameras
- MP3 Player
- Wireless Modem

DESCRIPTION

The Si91871 is a 300-mA CMOS LDO (low dropout) voltage regulator. It is the perfect choice for low voltage, low power applications. An ultra low ground current makes this part attractive for battery operated power systems. The Si91871 also offers ultra low dropout voltage to prolong battery life in portable electronics. Systems requiring a quiet voltage source, such as RF applications, will benefit from the Si91871's ultra low output noise. An external noise bypass capacitor connected to the device's BP pin can further reduce the noise level. The Si91871 is designed to maintain regulation while delivering 400-mA peak current, making it ideal for systems that have a high surge current upon turn-on.

pull-down circuit is built into the Si91871 to clamp the output voltage when it rises beyond normal regulation. The Si91871 automatically discharges the output voltage by connecting the output to ground through a 100- Ω n-channel MOSFET when the device is put in shutdown mode.

The Si91871 features reverse battery protection to limit reverse current flow to approximately 1- μA in the event reversed battery is applied at the input, thus preventing damage to the IC.

The Si91871 is available in both the standard and lead (Pb)-free 5-pin MLP33 PowerPAK packages and is specified to operate over the industrial temperature range of -40°C to 85°C .

For better transient response and regulation, an active

TYPICAL APPLICATION CIRCUIT

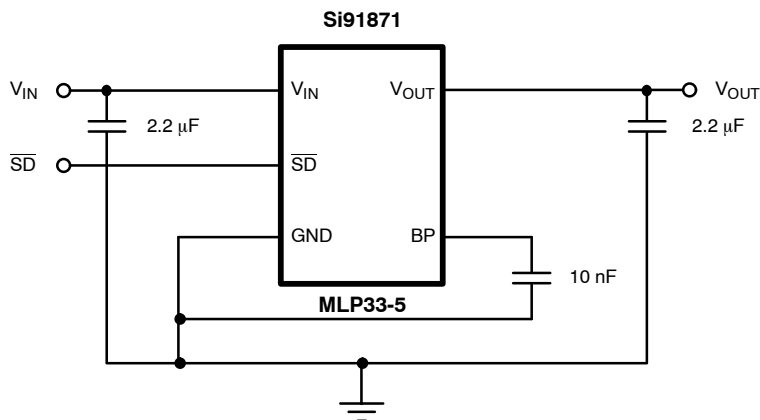



ABSOLUTE MAXIMUM RATINGS

Absolute Maximum Ratings	
Input Voltage, V_{IN} to GND	-6.0 to 6.5 V
$\overline{V_{SD}}$ (See Detailed Description)	-0.3 V to V_{IN}
Output Current, I_{OUT}	Short Circuit Protected
Output Voltage, V_{OUT}	-0.3 V to $V_{IN} + 0.3$ V
Package Power Dissipation, $(P_d)^b$	2.3 W

Thermal Resistance (θ_{JA}) ^a	55°C/W
$R_{(\theta JA)}$ ^a	8°C/W
Maximum Junction Temperature, $T_{J(max)}$	150°C
Storage Temperature, T_{STG}	-65°C to 150°C
Notes	
a.	Device mounted with all leads soldered or welded to PC board.
b.	Derate 20 mW/°C above $T_A = 25^\circ\text{C}$

Stresses beyond those listed under "Absolute Maximum Ratings" may cause permanent damage to the device. These are stress ratings only, and functional operation of the device at these or any other conditions beyond those indicated in the operational sections of the specifications is not implied. Exposure to absolute maximum rating conditions for extended periods may affect device reliability.

Input Voltage, V_{IN}	2 V to 6 V
Input Voltage, $\overline{V_{SD}}$	0 V to V_{IN}
Output Current	0 to 300 mA
C_{IN} , C_{OUT}^a (Ceramic)	2.2 μF

C_{EB} (Ceramic)	0.01 μF
Operating Ambient Temperature, T_A	-40°C to 85°C
Operating Junction Temperature, T_J	-40°C to 125°C
Notes	
a.	Maximum ESR of C_{OUT} : 0.2 Ω .

SPECIFICATIONS								
Parameter	Symbol	Test Conditions Unless Specified $T_A = 25^\circ\text{C}$, $V_{IN} = V_{OUT(nom)} + 1$ V $I_{OUT} = 1$ mA, $C_{IN} = 2$ μF , $C_{OUT} = 2.0$ μF $\overline{V_{SD}} = 1.5$ V		Limits -40 to 85°C			Unit	
				Temp ^a	Min ^b	Typ ^c		Max ^b
Start-Up BP Current	I_{OUT}	ON/OFF = High		Room		1	mA	
Input Voltage Range	V_{IN}			Full	2		6	V
Output Voltage Accuracy		$1 \text{ mA} \leq I_{OUT} \leq 300 \text{ mA}$	$V_{OUT} \geq 1.8 \text{ V}$	Room	-2.0	1	2.0	%
				Full	-3.0	1	3.0	
			$V_{OUT} = 1.2 \text{ V}, 1.5 \text{ V}$	Room	-2.5	1	2.5	
				Full	-3.5	1	3.5	
Line Regulation ($V_{OUT} \leq 3$ V)	$\frac{\Delta V_{OUT} \times 100}{\Delta V_{IN} \times V_{OUT(nom)}}$	From $V_{IN} = V_{OUT(nom)} + 1$ V to $V_{OUT(nom)} + 2$ V		Full	-0.06		0.18	%V
Line Regulation (3.0 V < $V_{OUT} \leq 3.6$ V)				Full	0		0.3	
Line Regulation (5-V Version)		From $V_{IN} = 5.5$ V to 6 V		Full	0		0.4	
Dropout Voltage ^{d, g} ($V_{OUT(nom)} \geq 2.6$ V)	$V_{IN} - V_{OUT}$	$I_{OUT} = 1$ mA		Room		1		mV
		$I_{OUT} = 50$ mA		Room		45	80	
				Full		50	90	
		$I_{OUT} = 300$ mA		Room		300	350	
				Full			415	
				Full				
Dropout Voltage ^{d, g} ($V_{OUT(nom)} < 2.6$ V, $V_{IN} \geq 2$ V)	$V_{IN} - V_{OUT}$	$I_{OUT} = 50$ mA		Room		65	100	mV
				Full			120	
		$I_{OUT} = 300$ mA		Room		400	520	
				Full			570	
				Room		100	150	
				Full			180	
Ground Pin Current ^{e, g} ($V_{OUT(nom)} \leq 3$ V)	I_{GND}	$I_{OUT} = 0$ mA		Room		130	200	μA
				Full			330	
		$I_{OUT} = 300$ mA		Room		110	170	
				Full			200	
		$I_{OUT} = 0$ mA		Room		150	225	
				Full			275	
Ground Pin Current ^e ($V_{OUT(nom)} > 3$ V)	I_{GND}	$I_{OUT} = 0$ mA		Room		150	225	μA
				Full			275	
Peak Output current	$I_{(peak)}$	$V_{OUT} \geq 0.95 \times V_{OUT(nom)}$, $t_{PW} = 2$ ms		Full	400			mA

SPECIFICATIONS							
Parameter	Symbol	Test Conditions Unless Specified $T_A = 25^\circ\text{C}$, $V_{IN} = V_{OUT(nom)} + 1\text{ V}$ $I_{OUT} = 1\text{ mA}$, $C_{IN} = 2\text{ }\mu\text{F}$, $C_{OUT} = 2.0\text{ }\mu\text{F}$ $V_{SD} = 1.5\text{ V}$	Temp ^a	Limits -40 to 85°C			Unit
				Min ^b	Typ ^c	Max ^b	
Output Noise Voltage	e_N	$V_{NOM} = 2.6\text{ V}$, BW = 10 Hz to 100 kHz, $0\text{ mA} < I_{OUT} < 300\text{ mA}$, $C_{NOISE} = 0.01\text{ }\mu\text{F}$	Room		30		$\mu\text{V(rms)}$
Ripple Rejection	$\Delta V_{OUT}/\Delta V_{IN}$	$I_{OUT} = 300\text{ mA}$	$f = 1\text{ kHz}$	Room		60	dB
			$f = 10\text{ kHz}$	Room		40	
			$f = 100\text{ kHz}$	Room		30	
Dynamic Line Regulation	$\Delta V_{O(line)}$	$V_{IN} : V_{OUT(nom)} + 1\text{ V}$ to $V_{OUT(nom)} + 2\text{ V}$ $t_r/t_f = 2\text{ }\mu\text{s}$, $I_{OUT} = 300\text{ mA}$	Room		20		mV
Dynamic Load Regulation	$\Delta V_{O(load)}$	$I_{OUT} : 1\text{ mA}$ to 300 mA , $t_r/t_f = 2\text{ }\mu\text{s}$	Room		20		
Thermal Shutdown Junction Temperature	$T_{J(S/D)}$		Room		150		°C
Thermal Hysteresis	T_{HYST}		Room		20		
Reverse current	I_R	$V_{IN} = -6.0\text{ V}$	Room		1		μA
Short Circuit Current	I_{SC}	$V_{OUT} = 0\text{ V}$	Room		700		mA
Shutdown							
Shutdown Supply Current	$I_{CC(off)}$	$V_{SD} = 0\text{ V}$	Room		0.1	1	μA
$\overline{\text{SD}}$ Pin Input Voltage	V_{SD}	High = Regulator ON (Rising)	Full	1.5		V_{IN}	V
		Low = Regulator OFF (Falling)	Full			0.4	
Auto Discharge Resistance	R_{DIS}		Room		100		Ω
$\overline{\text{SD}}$ Pin Input Current ^f	$I_{IN(SD)}$	$V_{SD} = 1.5\text{ V}$, $V_{IN} = 6\text{ V}$	Room		0.7		μA
$\overline{\text{SD}}$ Hysteresis	$V_{HYST(SD)}$		Full		150		mV
V_{OUT} Turn-On Time	t_{ON}	V_{SD} (See Figure 1), $I_{LOAD} = 100\text{ nA}$			50		μs

Notes

- a. Room = 25°C, Full = -40 to 85°C.
- b. The algebraic convention whereby the most negative value is a minimum and the most positive a maximum.
- c. Typical values are for DESIGN AID ONLY, not guaranteed nor subject to production testing. Typical values for dropout voltage at $V_{OUT} \geq 2\text{ V}$ are measured at $V_{OUT} = 3.3\text{ V}$, while typical values for dropout voltage at $V_{OUT} < 2\text{ V}$ are measured at $V_{OUT} = 1.8\text{ V}$.
- d. Dropout voltage is defined as the input to output differential voltage at which the output voltage drops 2% below the output voltage measured with a 1-V differential, provided that V_{IN} does not drop below 2.0 V.
- e. Ground current is specified for normal operation as well as “drop-out” operation.
- f. The device’s shutdown pin includes a typical 2-M Ω internal pull-down resistor connected to ground.
- g. $V_{OUT(nom)}$ is V_{OUT} when measured with a 1-V differential to V_{IN} .

TIMING WAVEFORMS

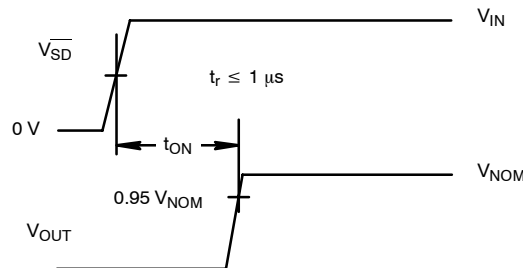
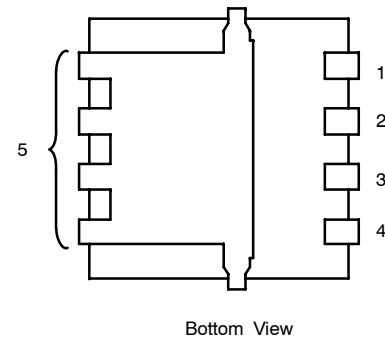
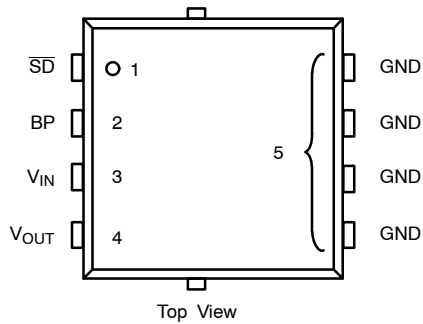

FIGURE 1. Timing Diagram for Power-Up

PIN CONFIGURATION
MLP33-5 PowerPAK

PIN DESCRIPTION

Pin Number	Name	Function
1	\overline{SD}	By applying less than 0.4 V to this pin, the device will be turned off. Connect this pin to V_{IN} if unused
2	BP	Noise bypass pin. For low noise applications, a 0.01 μF ceramic capacitor should be connected from this pin to ground.
3	V_{IN}	Input supply pin. Bypass this pin with a 1- μF ceramic or tantalum capacitor to ground
4	V_{OUT}	Output voltage. Connect C_{OUT} between this pin and ground.
5	GND	Ground pin. For better thermal capability, directly connected to large ground plane

ORDERING INFORMATION

Standard Part Number	Lead (Pb)-Free Part Number	Marking	Voltage	Temp. Range	Pkg.
Si91871DMP-12-T1	Si91871DMP-12-E3	7112	1.2	-40 to 85°C	MLP33-5
Si91871DMP-18-T1	Si91871DMP-18-E3	7118	1.8		
Si91871DMP-25-T1	Si91871DMP-25-E3	7125	2.5		
Si91871DMP-26-T1	Si91871DMP-26-E3	7126	2.6		
Si91871DMP-28-T1	Si91871DMP-28-E3	7128	2.8		
Si91871DMP-30-T1	Si91871DMP-30-E3	7130	3.0		
Si91871DMP-33-T1	Si91871DMP-33-E3	7133	3.3		
Si91871DMP-50-T1	Si91871DMP-50-E3	7150	5.0		

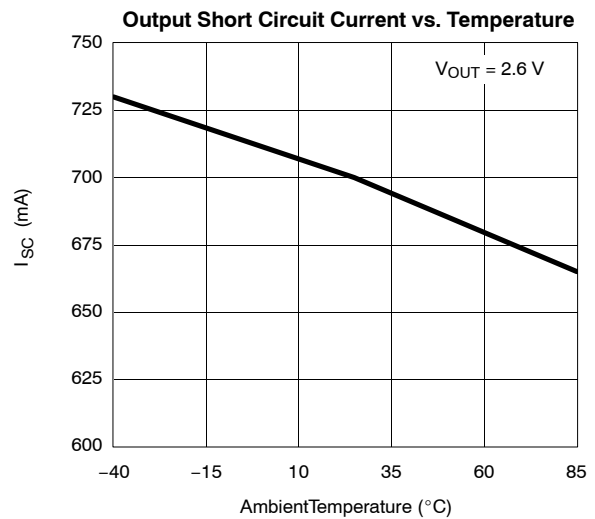
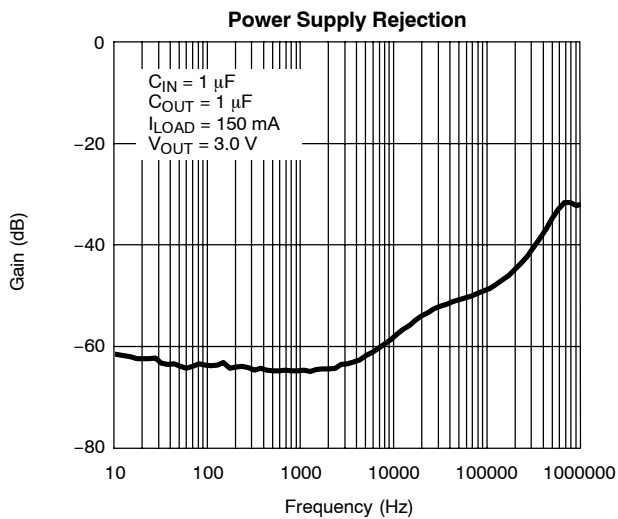
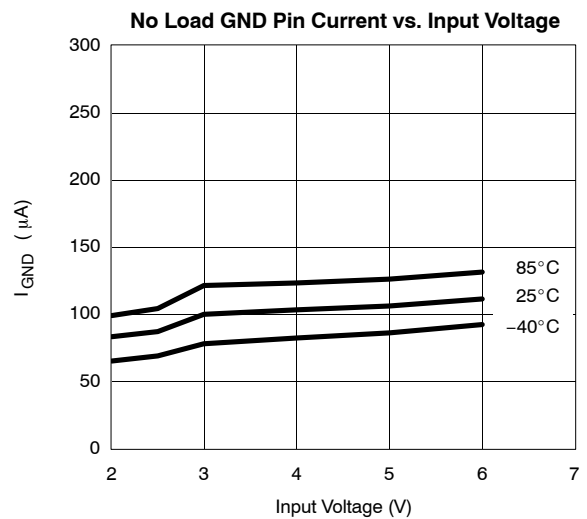
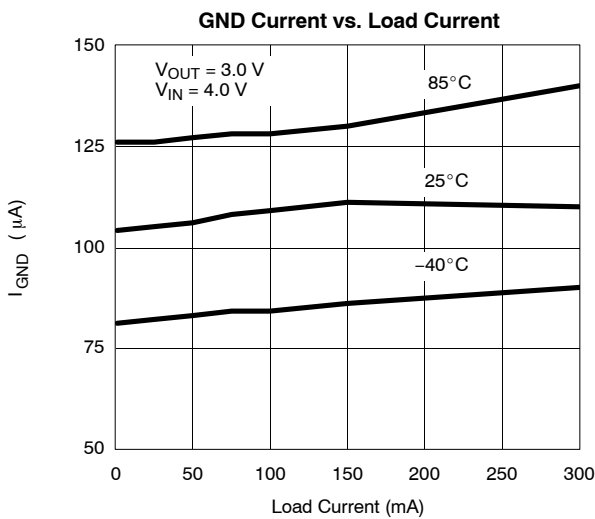
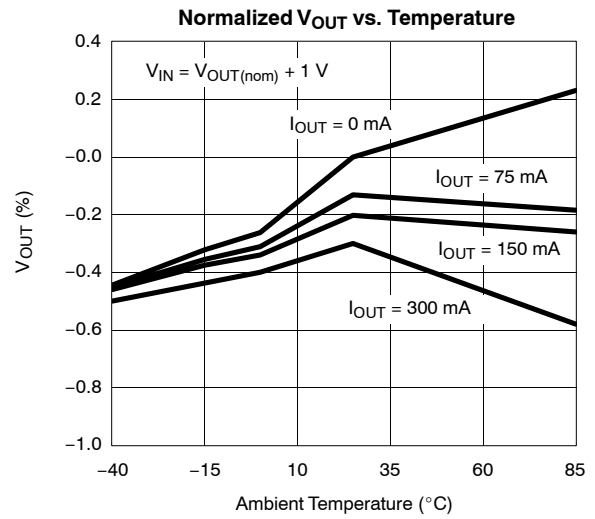
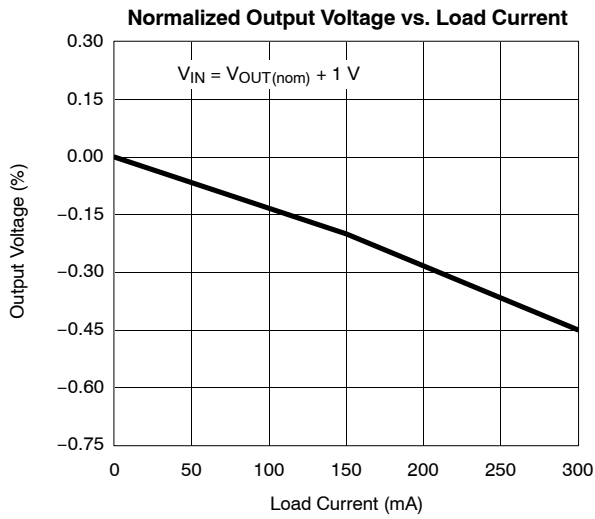
TYPICAL CHARACTERISTICS (INTERNALLY REGULATED, 25°C UNLESS NOTED)



TYPICAL CHARACTERISTICS (INTERNALLY REGULATED, 25°C UNLESS NOTED)

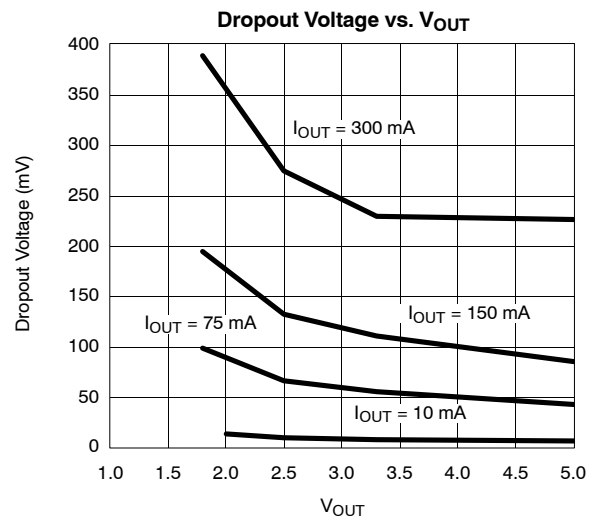
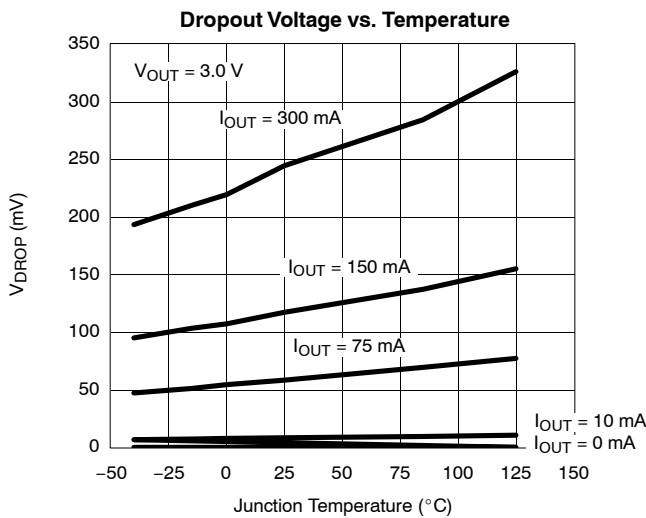
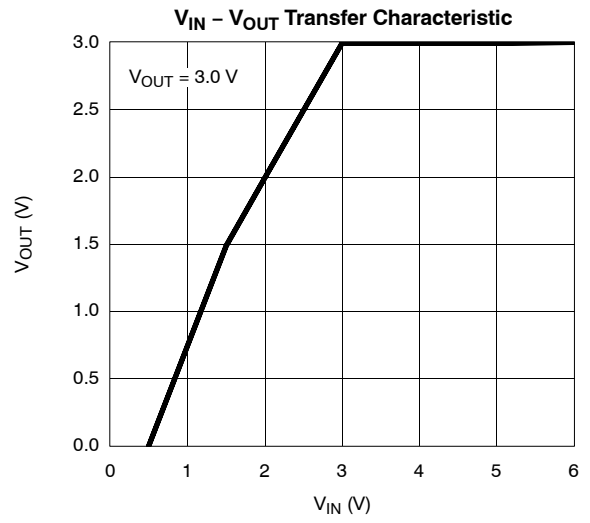
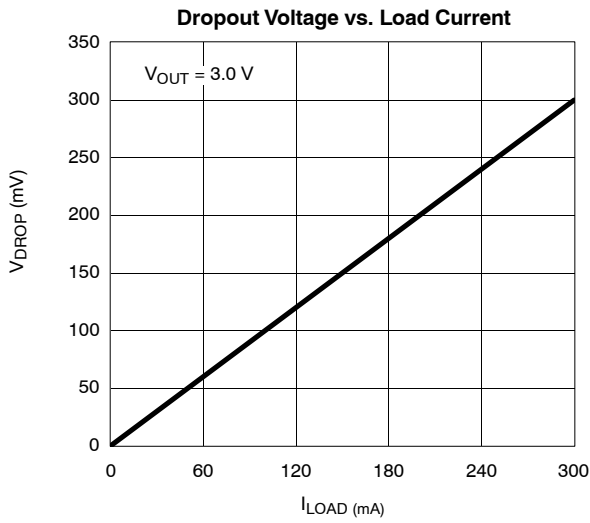

TYPICAL WAVEFORMS

Load Transient Response-1

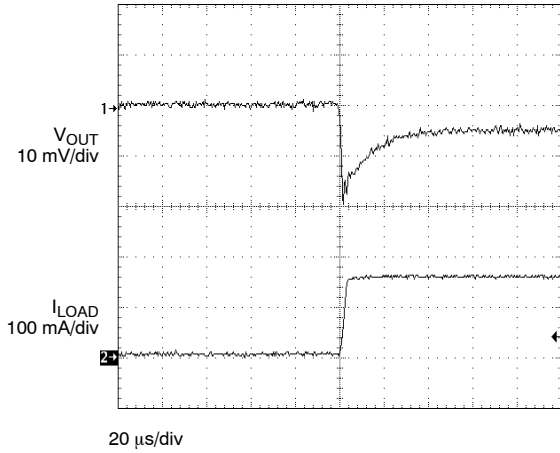

$V_{OUT} = 3.0\text{ V}$
 $C_{OUT} = 1\ \mu\text{F}$
 $I_{LOAD} = 1\ \text{to}\ 150\ \text{mA}$
 $t_{rise} = 2\ \mu\text{sec}$

Load Transient Response-2

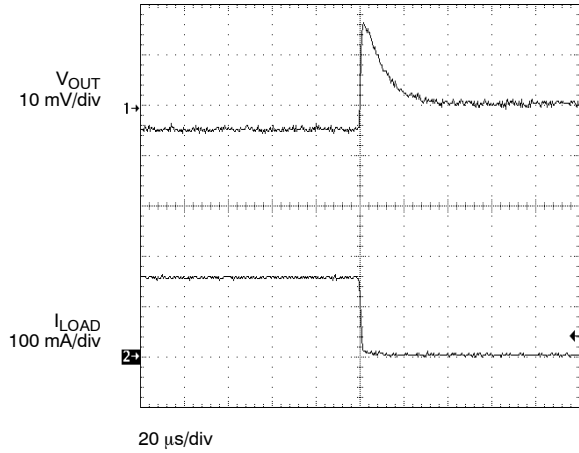

$V_{OUT} = 3.0\text{ V}$
 $C_{OUT} = 1\ \mu\text{F}$
 $I_{LOAD} = 150\ \text{to}\ 1\ \text{mA}$
 $t_{fall} = 2\ \mu\text{sec}$

Line Transient Response-1

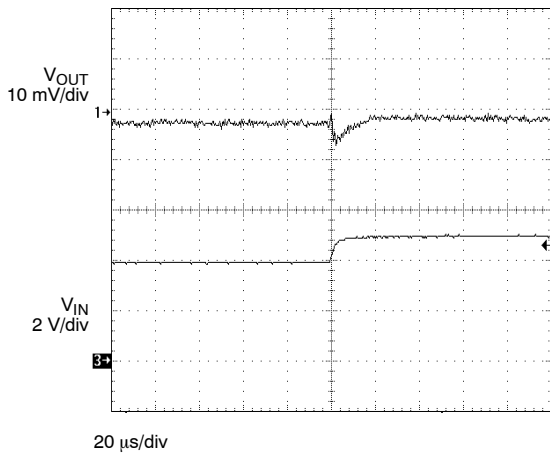

$V_{INSTEP} = 4\ \text{to}\ 5\ \text{V}$
 $V_{OUT} = 3\ \text{V}$
 $C_{OUT} = 1\ \mu\text{F}$
 $C_{IN} = 1\ \mu\text{F}$
 $I_{LOAD} = 150\ \text{mA}$
 $t_{rise} = 5\ \mu\text{sec}$

Line Transient Response-2

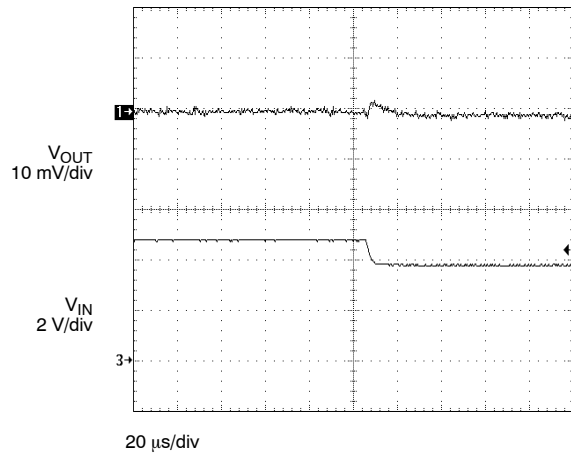

$V_{INSTEP} = 5\ \text{to}\ 4\ \text{V}$
 $V_{OUT} = 3\ \text{V}$
 $C_{OUT} = 1\ \mu\text{F}$
 $C_{IN} = 1\ \mu\text{F}$
 $I_{LOAD} = 150\ \text{mA}$
 $t_{fall} = 5\ \mu\text{sec}$

TYPICAL WAVEFORMS

Output Noise

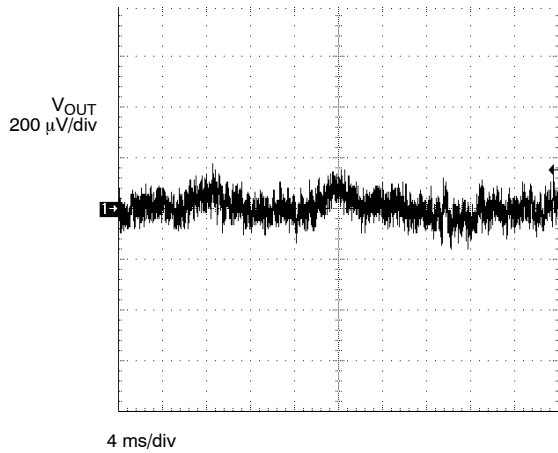

$V_{IN} = 4\text{ V}$
 $V_{OUT} = 3\text{ V}$
 $I_{LOAD} = 150\text{ mA}$
 $C_{NOISE} = 0.01\text{ }\mu\text{F}$
 $BW = 10\text{ Hz to }100\text{ kHz}$

Noise Spectrum

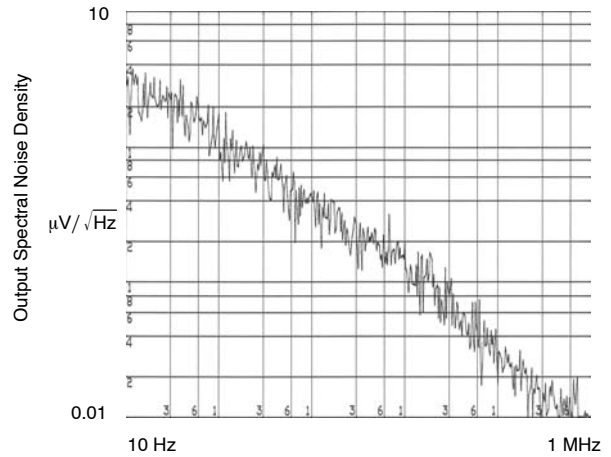

$V_{IN} = 4\text{ V}$
 $V_{OUT} = 3\text{ V}$
 $I_{LOAD} = 150\text{ mA}$
 $C_{NOISE} = 0.01\text{ }\mu\text{F}$

FUNCTIONAL BLOCK DIAGRAM

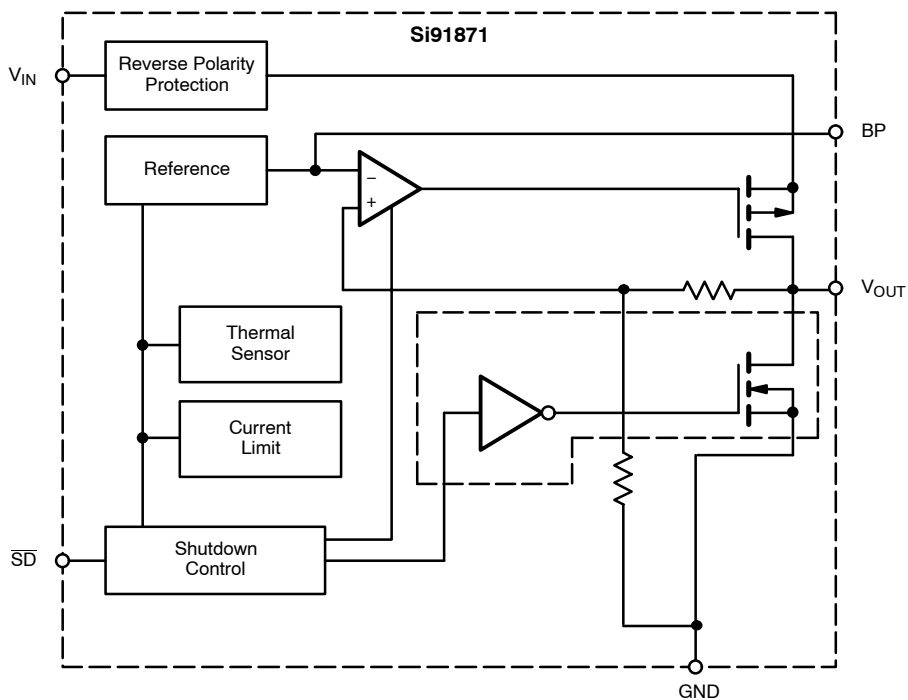

DETAILED DESCRIPTION

The Si91871 is a low-noise, low drop-out and low quiescent current linear voltage regulator, packaged in a small footprint MLP33-5 package. The Si91871 can supply loads up to 300 mA. As shown in the block diagram, the circuit consists of a bandgap reference error, amplifier, p-channel pass transistor and feedback resistor string. An external bypass capacitor connected to the BP pin reduces noise at the output. Additional blocks, not shown in the block diagram, include a precise current limiter, reverse battery and current protection and thermal sensor.

Thermal Overload Protection

The thermal overload protection limits the total power dissipation and protects the device from being damaged. When the junction temperature exceeds 150°C, the device turns the p-channel pass transistor off.

Reverse Battery Protection

The Si91871 has a battery reverse protection circuitry that disconnects the internal circuitry when V_{IN} drops below the GND voltage. There is no current drawn in such an event. When the \overline{SD} pin is hardwired to V_{IN} , the user must connect the \overline{SD} pin to V_{IN} via a 100-k Ω resistor if reverse battery protection is desired. Hardwiring the \overline{SD} pin directly to the V_{IN} pin is allowed when reverse battery protection is not desired.

Noise Reduction

An external 10-nF bypass capacitor at BP is used to create a low pass filter for noise reduction. The start-up time is fast, since a power-on circuit pre-charges the bypass capacitor. After the power-up sequence the pre-charge circuit is switched to standby mode in order to save current. It is therefore not recommended to use larger bypass capacitor values than 50 nF. When the circuit is used without a capacitor, stable operation is guaranteed.

Auto-Discharge

The Si91871 V_{OUT} has an internal 100- Ω (typ.) discharge path to ground when the \overline{SD} pin is low.

Stability

The circuit is stable with only a small output capacitor equal to 6 nF/mA (= 2 μ F @ 300 mA). Since the bandwidth of the error amplifier is around 1–3 MHz and the dominant pole is at the output node, the capacitor should be capacitive in this range, i.e., for 150-mA load current, an ESR <0.2 Ω is necessary. Parasitic inductance of about 10 nH can be tolerated.

Safe Operating Area

The ability of the Si91871 to supply current is ultimately dependent on the junction temperature of the pass device. Junction temperature is in turn dependent on power

dissipation in the pass device, the thermal resistance of the package and the circuit board, and the ambient temperature. The power dissipation is defined as

$$P_D = (V_{IN} - V_{OUT}) * I_{OUT}$$

Junction temperature is defined as

$$T_J = T_A + ((P_D * (R_{\theta JC} + R_{\theta CA})))$$

To calculate the limits of performance, these equations must be rewritten.

Allowable power dissipation is calculated using the equation

$$P_D = (T_J - T_A) / (R_{\theta JC} + R_{\theta CA})$$

While allowable output current is calculated using the equation

$$I_{OUT} = (T_J - T_A) / (R_{\theta JC} + R_{\theta CA}) * (V_{IN} - V_{OUT})$$

Ratings of the Si91871 that must be observed are

$$T_{Jmax} = 125 \text{ }^\circ\text{C}, T_{Amax} = 85 \text{ }^\circ\text{C}, (V_{IN} - V_{OUT})_{max} = 5.3 \text{ V}, R_{\theta JC} = 8 \text{ }^\circ\text{C/W}$$

The value of $R_{\theta CA}$ is dependent on the PC board used. The value of $R_{\theta CA}$ for the board used in device characterization is approximately 46 $^\circ\text{C/W}$.

Figure 1 shows the performance limits graphically for the Si91871 mounted on the circuit board used for thermal characterization.

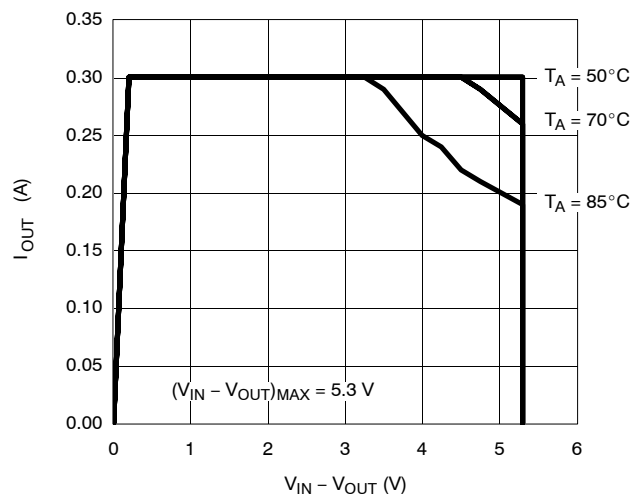

Figure 1. Safe Operating Area

Vishay Siliconix maintains worldwide manufacturing capability. Products may be manufactured at one of several qualified locations. Reliability data for Silicon Technology and Package Reliability represent a composite of all qualified locations. For related documents such as package/tape drawings, part marking, and reliability data, see <http://www.vishay.com/ppg?72012>.



Disclaimer

All product specifications and data are subject to change without notice.

Vishay Intertechnology, Inc., its affiliates, agents, and employees, and all persons acting on its or their behalf (collectively, "Vishay"), disclaim any and all liability for any errors, inaccuracies or incompleteness contained herein or in any other disclosure relating to any product.

Vishay disclaims any and all liability arising out of the use or application of any product described herein or of any information provided herein to the maximum extent permitted by law. The product specifications do not expand or otherwise modify Vishay's terms and conditions of purchase, including but not limited to the warranty expressed therein, which apply to these products.

No license, express or implied, by estoppel or otherwise, to any intellectual property rights is granted by this document or by any conduct of Vishay.

The products shown herein are not designed for use in medical, life-saving, or life-sustaining applications unless otherwise expressly indicated. Customers using or selling Vishay products not expressly indicated for use in such applications do so entirely at their own risk and agree to fully indemnify Vishay for any damages arising or resulting from such use or sale. Please contact authorized Vishay personnel to obtain written terms and conditions regarding products designed for such applications.

Product names and markings noted herein may be trademarks of their respective owners.