

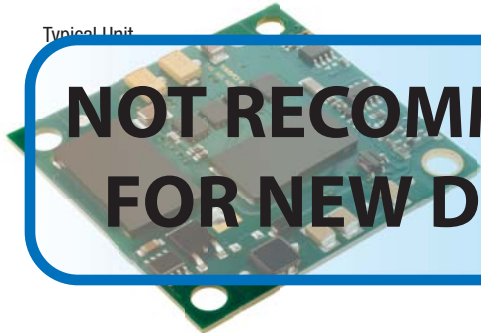

# Single Output UCH Models

Isolated, "Half-Brick"  
1.8–15V Output DC/DC Converters



## PRODUCT OVERVIEW

The high efficiency, low noise and long-term reliability of the Murata Power Solutions' DC/DC converters now come to you in the standard "half-brick" configuration (2.3" x 2.4" x 0.40"). The new UCH Series is certified to UL/EN60950-1 (some models pending), including each European country's deviations. All models have DABIG insulation, guarantee 2250Vdc (in to out) isolation; and because they are designed with Class B thermal insulation, satisfy all safety requirements over their full operating temperatures. Construction/attach meets stringent RoHS-6 specifications.

UCH Models are designed for demanding telecom, datacom and networking applications. Their "semi-synchronous-rectifier" design achieves

impressive efficiencies. Output voltages are 1.8 to 15 Volts. The input voltage range is 36 to 75 or 18 to 36 Volts. All models meet the Low Voltage Directive (LVD).

For high reliability and affordability, Murata Power Solutions utilizes high-speed automatic assembly to construct the UCH's proven SMT-on-pcb designs. An optional baseplate offers full output power at maximum temperature.

UCH's feature input filters, input undervoltage and overvoltage lockout, output current limiting, short-circuit protection, and thermal shutdown. Additionally, all devices have output trim capability and an on/off control pin that can be ordered with either logic type.

## FEATURES

- Standard "half-brick" configuration
- Certified to UL-60950-1, CSA-C22.2 No. 60950-1, IEC/EN 60950-1, 2nd edition (some models pending)
- Fully isolated, 2250Vdc guaranteed
- Output voltages: 1.8 – 15 Volts
- $V_{IN}$  range: 36-75V or 18-36V
- Full 50-150 Watt output power
- Reliable SMT-on-pcb construction
- Input under and output overvoltage shutdown
- Output current limiting and short-circuit protection
- On/off,  $V_{out}$  trim and sense functions
- Modifications and customs for OEMs
- RoHS-6 construction/attach

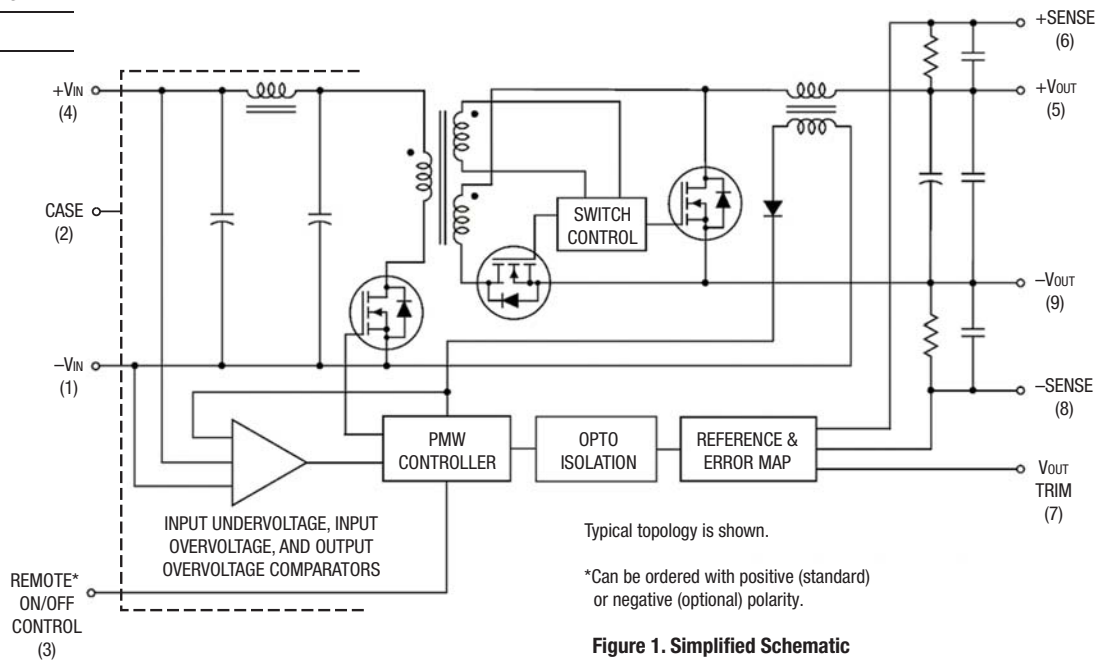

Figure 1. Simplified Schematic



PERFORMANCE SPECIFICATIONS SUMMARY AND ORDERING GUIDE ①																			
Root Family ①	Output						Input				Efficiency		Package C61 Case inches (mm)						
	V <sub>OUT</sub> (Volts)	I <sub>OUT</sub> (Amps)	Power (Watts)	R/N (mVp-p) ②		Regulation (Max.)		V <sub>IN</sub> Nom. (Volts)	Range (Volts)	I <sub>IN</sub> , no load (mA)	I <sub>IN</sub> , full load (Amps)	Min.		Typ.					
				Typ.	Max.	Line	Load												
<b>OBSOLETE</b> ✖ 1.8/40-D48N-C	1.8	40	72	50	100	±0.125%	±0.25%	48	36-75	50	1.72	85%	87%	2.4×2.28×0.40 (61×57.9×10.2)					
<b>OBSOLETE</b> ✖ 2.5/40-D48N-C	2.5	40	100	50	100	±0.1%	±0.2%	48	36-75	50	2.34	87.5%	89%						
<b>OBSOLETE</b> ✖ 3.3/10-D24P-C	3.3	10	33								80	±0.2%			24	18-36	1.54		
<b>OBSOLETE</b> ✖ 3.3/10-D48N-C		10	33									±0.2%			48	36-75	0.77		
<b>OBSOLETE</b> ✖ 3.3/15-D48N-C		15	49.5									±0.125%			48	36-75	1.16		
<b>OBSOLETE</b> ✖ 3.3/35-D24P-C		35	115.5									±0.125%			24	18-36	5.41		
<b>OBSOLETE</b> ✖ 3.3/30-D48N-C		30	99									±0.125%			48	36-75	2.29	89%	90%
<b>OBSOLETE</b> ✖ 5/10-D48N-C		10	50									60			150	±0.125%	±0.25%	48	36-75
UCH-5/20-D24P-C		20	100	50	100	±0.125%	24	18-36	4.6	89%		90.5%							
<b>OBSOLETE</b> ✖ 5/30-D48N-C	30	150	60	100	±0.125%	48	36-75	3.43	91%	90.5%									
UCH-12/4.2-D48N-C	12	4.2	50.4	80	150			±0.125%	1.16		87.5%	90.5%							
UCH-12/12.5-D48N-C	12	12.5	150	50	150			±0.125%	3.37		89%	92.6%							
<b>OBSOLETE</b> ✖ 15/6.7-D48N-C ③	15	6.7	100.5	70	150	±0.125%	2.28	90%	92%										

① Please refer to the full model number structure for additional ordering part numbers and options.

② All specifications are at nominal line voltage and full load, +25 °C, unless otherwise noted. See detailed specifications. Output capacitors are 1 µF ceramic in parallel with 10 µF electrolytic. Input cap is 22 µF, low ESR. I/O caps are necessary for our test equipment and may not be needed for your application.

③ Pending UL and VDE certification.

**\* LAST TIME BUY: AUGUST 31, 2014. CLICK HERE FOR OBSOLESCENCE NOTICE OF FEBRUARY 2014.**

**As of September 2014, ONLY the following part numbers will be available: UCH-5/20-D24PB-C; UCH-12/4.2-D48N-C; UCH-12/4.2-D48NB-C; UCH-12/12.5-D48N-C; UCH-12/12.5-D48NB-C**

## PART NUMBER STRUCTURE

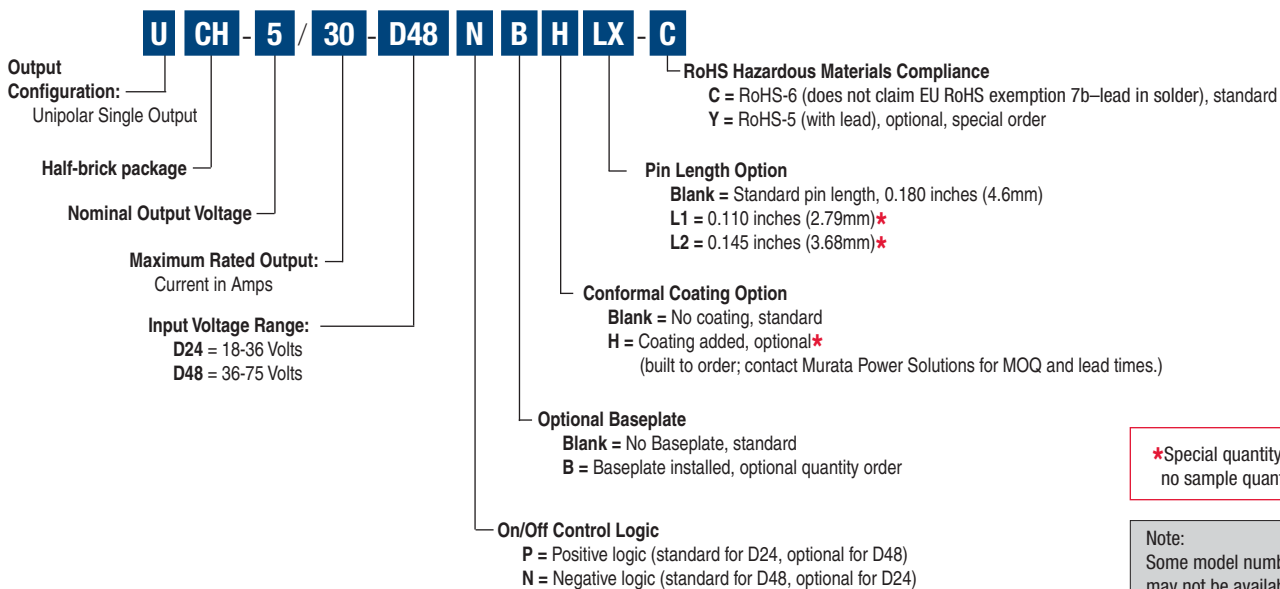

\*Special quantity order is required; no sample quantities available.

Note: Some model number combinations may not be available. Please contact Murata Power Solutions.

## FUNCTIONAL SPECIFICATIONS ①

	UCH-1.8/40-D48	UCH-2.5/40-D48	UCH-3.3/10-D24	UCH-3.3/10-D48	UCH-3.3/15-D48	UCH-3.3/35-D24	UCH-3.3/30-D48	
<b>Input</b>								
Input voltage range	See ordering guide							
Start-up threshold, Volts	34	34	16	34	34	16	34	
Undervoltage shutdown, V	32	31	15	31	31	15	31	
Overvoltage shutdown	none							
Reflected (back) ripple current, mA pk-pk	10	20	10	15	15	15	10	
<b>Input Current</b>								
Full load conditions	See ordering guide.							
Inrush transient, A <sup>2</sup> sec	0.05							
Output short circuit, mA	50							
Low line (V <sub>IN</sub> = min.), Amps	2.30	1.54	2.06	1.03	1.54	7.21	3.09	
Standby mode, mA (Off, UV, OT shutdown)	2	10					8	
Internal input filter type	Pi	L-C						
External recommended fast blow fuse, Amps	10	3	5	3	3	12.5	7.5	
Reverse polarity protection	None. Install external fuse.							
<b>Remote On/Off Control</b>								
Positive logic (P model suffix)	OFF = Ground pin to +1V max. ON = Open or +3.5 to +13.5V max							
Negative logic (N model suffix)	OFF = Open or +2.5V to +15V max. ON = -0.1V to +0.8V max							
Current, mA	1							
<b>Output</b>								
Voltage output range	See ordering guide.							
Voltage output accuracy	±1% of V <sub>NOM</sub> (50% load)							
Adjustment range	-10 to +10% of V <sub>NOM</sub> .							
Temperature coefficient over oper. temp. range	±0.02% of V <sub>OUT</sub> range per °C							
Minimum loading	No minimum loading.							
Remote sense compensation ⑦	+10%.							
Ripple/noise (20 MHz bandwidth)	See ordering guide.							
Line/Load regulation	See ordering guide.							
Efficiency	See ordering guide.							
Maximum capacitive loading, Low ESR <0.02Ω max., resistive load, μF	10,000 max.							

	UCH-5/10-D48	UCH-5/20-D24	UCH-5/30-D48	UCH-12/4.2-D48	UCH-12/12.5-D48	UCH-15/6.7-D48
<b>Input</b>						
Input voltage range	See ordering guide.					
Start-up threshold, Volts	34	16	35	35	35	35
Undervoltage shutdown, V	33	15	34	33.5	33.5	33
Overvoltage shutdown	none					
Reflected (back) ripple current, mA pk-pk	15	20	15	20	20	20
<b>Input Current</b>						
Full load conditions	See ordering guide.					
Inrush transient, A <sup>2</sup> sec	0.05					
Output short circuit, mA	50					
Low line (V <sub>IN</sub> = min.), Amps	1.54	6.17	4.63	1.51	4.47	3.06
Standby mode, mA (Off, UV, OT shutdown)	4	10	4	1		
Internal input filter type	Pi	L-C		Pi	L-C	
External recommended fast blow fuse, Amps	10	10	7.5	10	7.5	
Reverse polarity protection	None. Install external fuse.					
<b>Remote On/Off Control</b>						
Positive logic (P model suffix)	OFF = Ground pin to +1V max. ON = Open or +3.5 to +15V max					
Negative logic (N model suffix)	OFF = Open or +2.5V to +15V max. ON = -0.1V to +0.8V max					
Current, mA	1					
<b>Output</b>						
Voltage output range	See ordering guide.					
Voltage output accuracy	±1% of V <sub>NOM</sub> .					
Adjustment range	-10 to +10% of V <sub>NOM</sub> .					
Temperature coefficient over oper. Temp. range	±0.02% of V <sub>OUT</sub> range per °C					
Minimum loading	No minimum loading.					
Remote sense compensation ⓘ	+10%.					
Ripple/noise (20 MHz bandwidth)	See ordering guide.					
Line/Load regulation	See ordering guide.					
Efficiency	See ordering guide.					
Maximum capacitive loading, Low ESR <0.02Ω max., resistive load, μF	10,000	10,000 max.	20,000 max.	5000	10,000	1,000

	UCH-1.8/40-D48	UCH-2.5/40-D48	UCH-3.3/10-D24	UCH-3.3/10-D48	UCH-3.3/15-D48	UCH-3.3/35-D24	UCH-3.3/30-D48
<b>Isolation Voltage</b>							
Input to Output, Volts min.	2250						
Input to baseplate, Volts min.	1500						
Baseplate to output, Volts min.	1500						
Isolation resistance, MΩ	100						
Isolation capacitance, pF	1000						
Isolation safety rating	Basic insulation						
Current limit inception (98% of $V_{OUT}$ , after warmup), Amps	59 max.	49	15	15	19	40	35
Short circuit protection method	Current limiting, hiccup autorestart. Remove overload for recovery.						
Short circuit current, Amps	5						
Short circuit duration	Output may be shorted continuously to ground (no damage).						
Overvoltage protection, Volts (via magnetic feedback)	2.7 max.	3.75 max.	4.95 V max			4.62 max.	4.95 max.
Prebiased Startup	Starts if external voltage is less than $V_{NOM}$ .						
<b>Dynamic characteristics</b>							
Dynamic load response (50-75-50% load step)	100 μSec to ±1% of final value	100 μSec to ±1% of final value	200 μSec to ±1% of final value	200 μSec to ±1% of final value	200 μSec to ±1% of final value	200 μSec to ±1% of final value	200 μSec to ±1% of final value
Start-up time							
$V_{IN}$ to $V_{OUT}$ regulated, mSec	10 max.						
Remote On/Off to $V_{OUT}$ regulated, mSec	10 max.						
Switching frequency, KHz	360	420 ± 40	330 ± 40				
<b>Environmental</b>							
Calculated MTBF	1.6M hrs.	TBD			1.8M hrs.	TBD	
Operating ambient temperature range, °C (with derating)	-40 to +85 (See Derating Curves)						
Operating PC board temperature, °C	-40 to +110						
Storage temperature range, °C	-55 to +125						
Thermal protection/shutdown, °C	+115	+115	+120				
Relative humidity	To +85°C/85%, non-condensing						

## Soldering Guidelines

Murata Power Solutions recommends the specifications below when installing these converters. These specifications vary depending on the solder type. Exceeding these specifications may cause damage to the product. Your production environment may differ; therefore please thoroughly review these guidelines with your process engineers.

Wave Solder Operations for through-hole mounted products (THMT)			
For Sn/Ag/Cu based solders:		For Sn/Pb based solders:	
Maximum Preheat Temperature	115° C.	Maximum Preheat Temperature	105° C.
Maximum Pot Temperature	270° C.	Maximum Pot Temperature	250° C.
Maximum Solder Dwell Time	7 seconds	Maximum Solder Dwell Time	6 seconds

	UCH-5/10-D48	UCH-5/20-D24	UCH-5/30-D48	UCH-12/4.2-D48	UCH-12/12.5-D48	UCH-15/6.7-D48
<b>Isolation Voltage</b>						
Input to Output, Volts min.	2250					
Input to baseplate, Volts min.	1500					
Baseplate to output, Volts min.	1500					
Isolation resistance, MΩ	100					
Isolation capacitance, pF	1000					
Isolation safety rating	Basic insulation					
<b>Miscellaneous</b>						
Current limit inception (98% of $V_{OUT}$ , after warmup), Amps	13	26	35	5.4	14.5	7.4
Short circuit protection method	Current limiting, hiccup autorestart. Remove overload for recovery.					
Short circuit current, Amps	5					
Short circuit duration	Output may be shorted continuously to ground (no damage).					
Overvoltage protection, Volts (via magnetic feedback)	7.75 max.	7.5 max.	7.5	18 max.	16.8 max.	17.5
Prebiased Startup	Starts if external voltage is less than $V_{NOM}$ .					
<b>Dynamic characteristics</b>						
Dynamic load response (50-75-50% load step)	200 μSec to ±1% of final value	200 μSec to ±1% of final value	200 μSec to ±1% of final value	250 μSec to ±1% of final value	250 μSec to ±1% of final value	250 μSec to ±1% of final value
Start-up time						
$V_{IN}$ to $V_{OUT}$ regulated, mSec	10 max.					
Remote On/Off to $V_{OUT}$ regulated, mSec	10 max.					
Switching frequency, KHz	300 ± 30	330 ± 40	300 ± 30	335 ± 35	335 ± 35	350 ± 40
<b>Environmental</b>						
Calculated MTBF	1.6M hours	TBD	1.9M hours	1.6M hours	TBD	
Operating ambient temperature range, °C (with derating)	–40 to +85 (See Derating Curves)					
Operating PC board temperature, °C	–40 to +110					
Storage temperature range, °C	–55 to +125					
Thermal protection/shutdown, °C	+120					+115
Relative humidity	To +85°C/85%, non-condensing					

	UCH-1.8/40-D48	UCH-2.5/40-D48	UCH-3.3/10-D24	UCH-3.3/10-D48	UCH-3.3/15-D48	UCH-3.3/35-D24	UCH-3.3/30-D48
<b>Physical</b>							
Outline dimensions	See mechanical specs.						
Baseplate material	Aluminum						
Pin material	Gold plated copper alloy with nickel underplate						
Pin diameter	0.04/0.08 inches (1.016/2.032 mm)						
Weight, ounces	1.68			2			
Weight, grams	47			60			
Electromagnetic interference (conducted and radiated) (external filter required)	Certified to EN55022/CISPR22						
Flammability	UL94V-0						
Safety	Certified to UL 60950-1, CSA C22.2 No.60950-1, IEC/EN 60950-1, 2nd edition (some models pending).						

	UCH-5/10-D48	UCH-5/20-D24	UCH-5/30-D48	UCH-12/4.2-D48	UCH-12/12.5-D48	UCH-15/6.7-D48
<b>Physical</b>						
Outline dimensions	See mechanical specs.					
Baseplate material	Aluminum					
Pin material	Gold plated copper alloy with nickel underplate					
Pin diameter	0.04/0.08 inches (1.016/2.032 mm)					
Weight, ounces	2			1.73		
Weight, grams	60			49		
Electromagnetic interference (conducted and radiated) (external filter required)	Certified to EN55022/CISPR22					
Flammability	UL94V-0					
Safety	Certified to UL 60950-1, CSA C22.2 No.60950-1, IEC/EN 60950-1, 2nd edition (some models pending).					

### Absolute Maximum Ratings

<b>Input Voltage:</b>		
D24 Models -	Volts, max. continuous	0-36 VDC
	Volts, transient, 100 mSec	50 VDC
D48 Models -	Volts, max. continuous	0-75 VDC
	Volts, transient, 100 mSec	100 VDC
<b>On/Off Control</b>		
		-0.7 V. min to +15V max.
<b>Input Reverse-Polarity Protection</b>		
		None. Install external fuse.
<b>Output Overvoltage</b>		
		Vout nom. +20% max.
<b>Output Current</b>		
		Current-limited. Devices can withstand sustained short circuit without damage. The outputs are not intended to accept appreciable reverse current.
<b>Overtemperature Protection</b>		
		Device includes electronic overtemperature shutdown protection under normal operation.
<b>Storage Temperature</b>		
		-55 to +125° C
<b>Lead Temperature</b>		
		See soldering specifications

These are stress ratings. Exposure of devices to greater than any of these conditions may adversely affect long-term reliability. Proper operation under conditions other than those listed in the Performance/Functional Specifications Table is not implied.

### Specification Notes:

(1) All models are tested and specified with external 1  $\mu$ F paralleled with 10  $\mu$ F output capacitors and no external input capacitor. All capacitors are low ESR types. These capacitors are necessary to accommodate our test equipment and may not be required to achieve specified performance in your applications. All models are stable and regulate within spec under no-load conditions.

All specifications are typical unless noted. General conditions for Specifications are +25°C, Vin=nominal, Vout=nominal, full load. Adequate airflow must be supplied for extended testing under power.

(2) Input Back Ripple Current is tested and specified over a 5 Hz to 20 MHz bandwidth. Input filtering is Cin=33  $\mu$ F, 100V, Cbus=220  $\mu$ F, 100V, Lbus=12  $\mu$ H.

(3) Note that Maximum Power Derating curves indicate an average current at nominal input voltage. At higher temperatures and/or lower airflow, the DC/DC converter will tolerate brief full current outputs if the total RMS current over time does not exceed the Derating curve. All Derating curves are presented at sea level altitude. Be aware of reduced power dissipation with increasing altitude.

(4) Mean Time Before Failure is calculated using the Telcordia (Belcore) SR-332 Method 1, Case 3, ground fixed conditions, Tpcboard=+25°C, full load, natural air convection.

(5) The On/Off Control is normally selected by a switch or an open collector or open drain transistor. But it may also be driven with external logic or by applying appropriate external voltages which are referenced to Input Common and comply with the On/Off voltage specifications.

(6) Output current limiting begins when the output voltage degrades approximately 2% from the selected setting.

(7) The outputs are not intended to sink appreciable reverse current.

(8) Output noise may be further reduced by adding an external filter. Logic circuits with low power voltages may have a small voltage margin between logic ZERO and logic ONE, requiring noise suppression. Use only as much output filtering as needed to achieve your noise requirements. Excessive output capacitance can retard transient response or possibly cause instability. Low ESR ceramic capacitors may degrade dynamic performance. Be sure to thoroughly test your system under full load with all components installed.

(9) All models are fully operational and meet published specifications, including “cold start” at -40°C. At full power, the package temperature of all on-board components must not exceed +128°C.

(10) Regulation specifications describe the deviation as the line input voltage or output load current is varied from a nominal midpoint value to either extreme.

(11) The output overvoltage protection is automatic recovery. The overvoltage may occur either from internal failure or from an external forcing voltage as in a shared power system.

(12) Output current limit and short circuit protection is non-latching. When the overcurrent fault is removed, the converter will immediately recover. After an output overcurrent or short circuit, “hiccup” operation repeatedly attempts to restart the converter with a brief, full-current output. If the overcurrent condition still exists, the restart current will be removed and then tried again. This short current pulse prevents overheating and damaging the converter. Once the fault is removed, the converter immediately resumes normal operation.

(13) Do not exceed maximum power specifications when adjusting the output trim.

(14) At zero output current, the output may contain low frequency components which exceed the ripple specification. The output may be operated indefinitely with no load.

(15) If reverse polarity is accidentally applied to the input, to ensure reverse input protection with full output load, always connect an external input fuse in series with the +Vin input. Use approximately twice the full input current rating with nominal input voltage.

(16) Output accuracy is dependent on user-supplied trim resistors. To achieve high accuracy, use  $\pm$ 1% or better tolerance metal-film resistors mounted close to the converter.

(17) Normally, the Sense lines are connected at the remote load to compensate for IR voltage drops in the power wiring and to improve dynamic response. If Sense is not used, each Sense pin should be connected at the converter to its respective Vout pin.

**CAUTION:** This product is not internally fused. To comply with safety agency certifications and to avoid injury to personnel or equipment, the user must connect an external fast-blow fuse to the input terminals.



## TYPICAL PERFORMANCE DATA

**UCH-1.8/40-D48 Efficiency and Power Dissipation vs Line Voltage and Load Current @25°C**

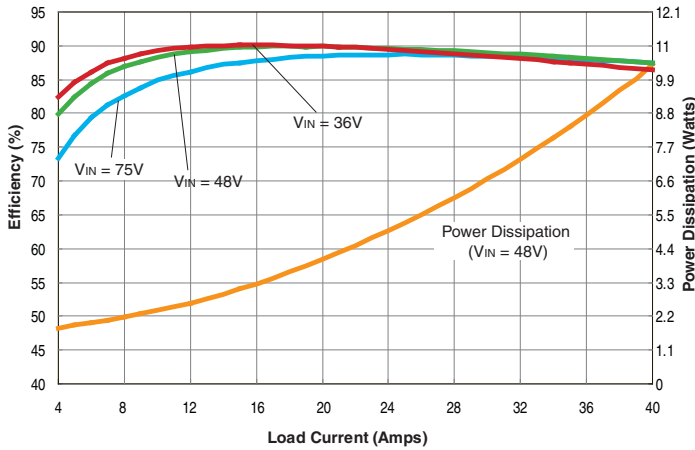

**UCH-1.8/40-D48 Maximum Current Temperature Derating (at sea level)**  
No baseplate,  $V_{IN} = 48V$ , airflow is from  $V_{IN}$  to  $V_{OUT}$

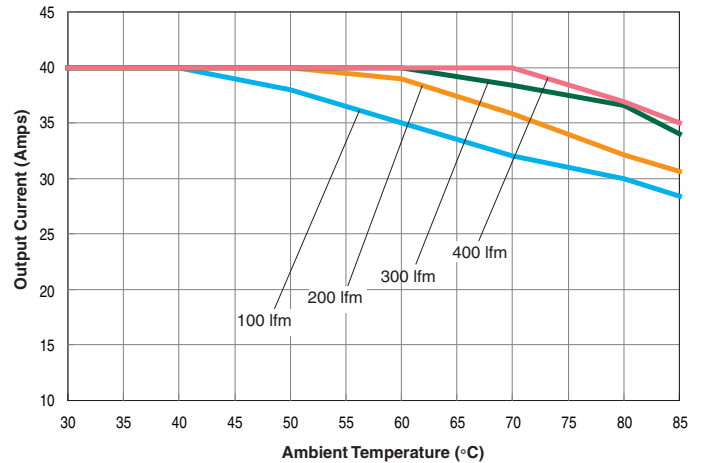

**UCH-2.5/40-D48 Efficiency and Power Dissipation vs Line Voltage and Load Current @25°C**

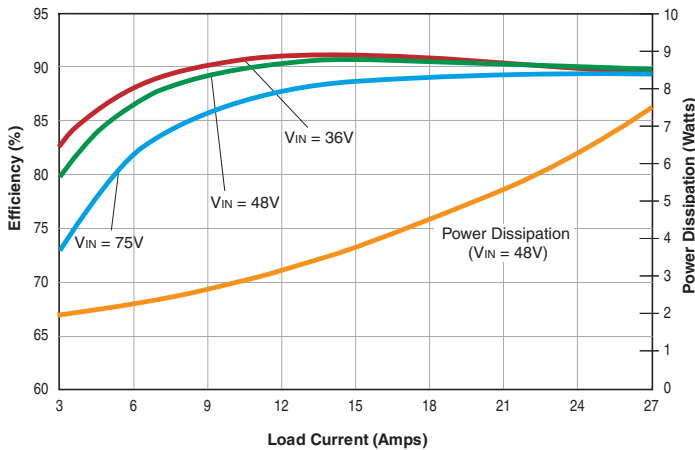

**UCH-2.5/40-D48 Maximum Current Temperature Derating (at sea level)**  
No baseplate,  $V_{IN} = 48V$ , transverse airflow

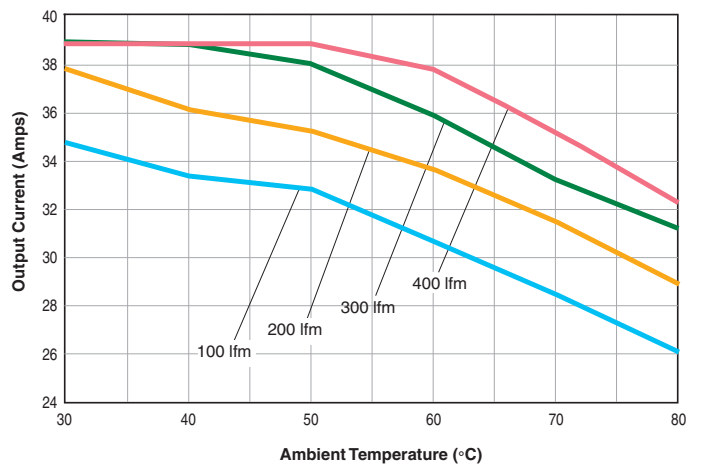

**UCH-3.3/10-D24 Efficiency and Power Dissipation vs Line Voltage and Load Current @25°C**

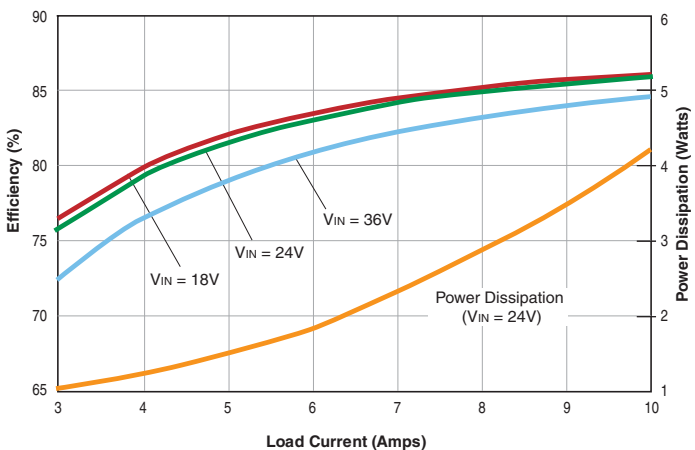

**UCH-3.3/10-D48 Maximum Current Temperature Derating vs Line Voltage and Load Current @25°C**

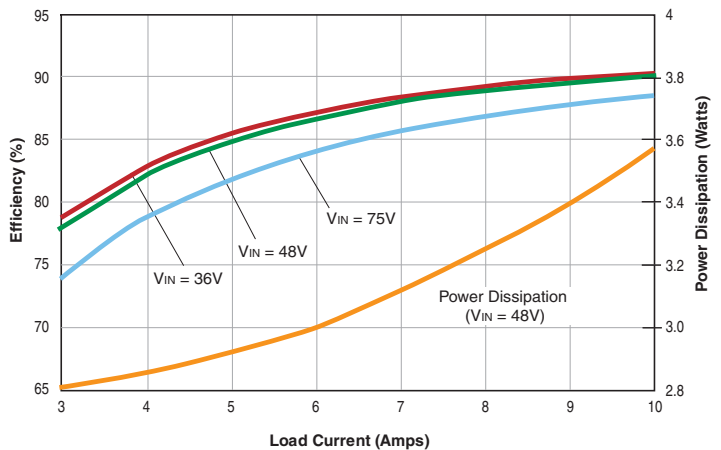

## TYPICAL PERFORMANCE DATA

**UCH-3.3/15-D48 Efficiency and Power Dissipation vs Line Voltage and Load Current @25°C**

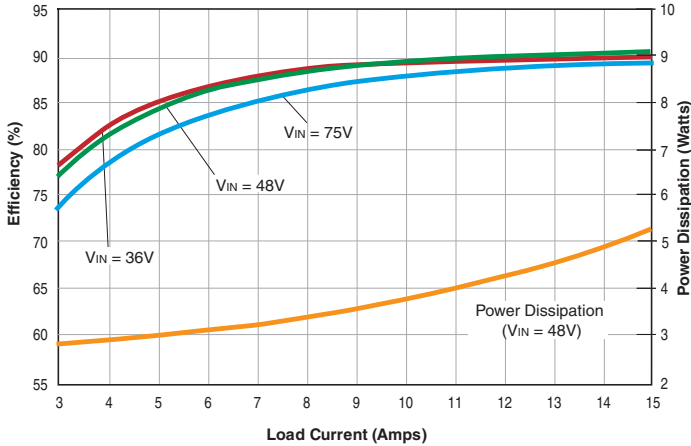

**UCH-3.3/35-D24 Efficiency and Power Dissipation vs Line Voltage and Load Current @25°C**

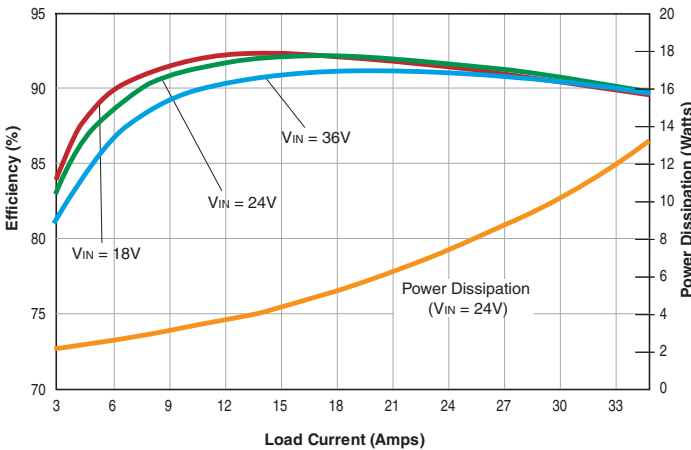

**UCH-3.3/30-D48 Efficiency and Power Dissipation vs Line Voltage and Load Current @25°C**

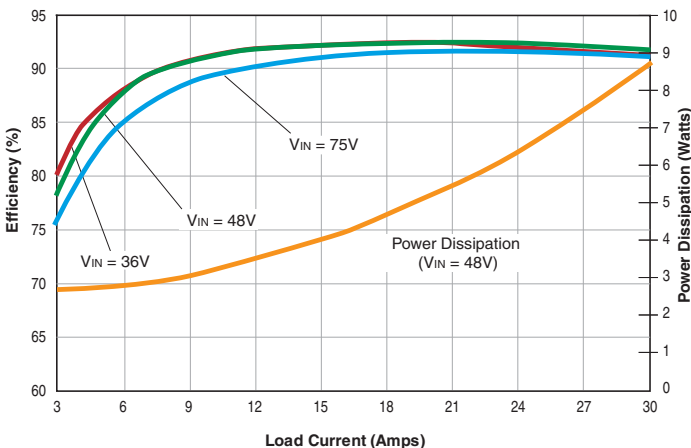

**UCH-3.3/35-D24 Maximum Current Temperature Derating (at sea level)**  
No baseplate,  $V_{IN} = 24V$ , transverse airflow

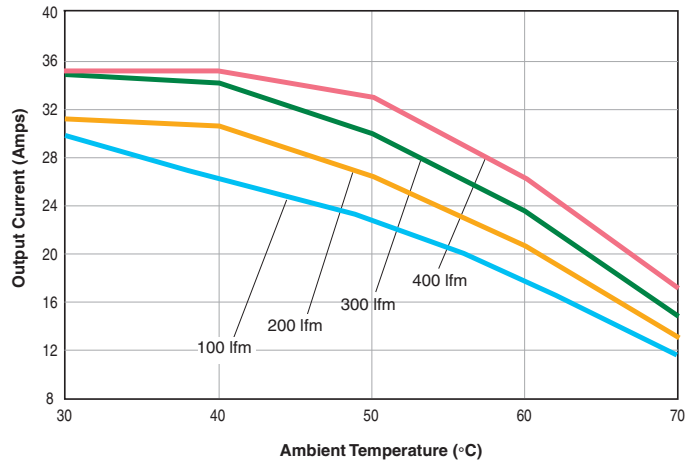

**UCH-3.3/30-D48 Maximum Current Temperature Derating (at sea level)**  
No baseplate,  $V_{IN} = 48V$ , transverse airflow

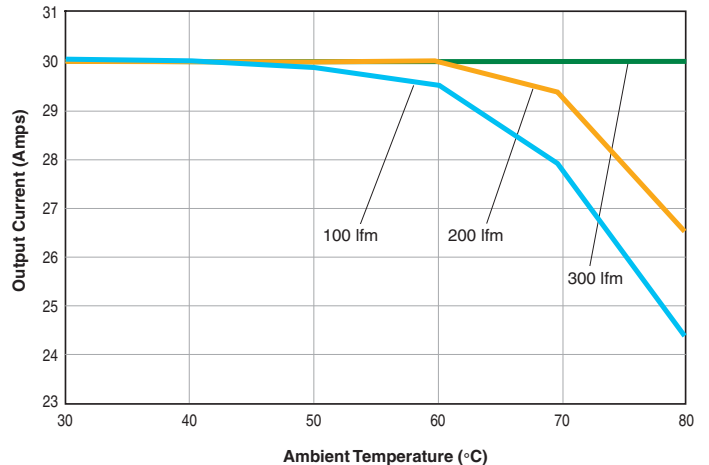

## TYPICAL PERFORMANCE DATA

**UCH-5/20-D24 Efficiency and Power Dissipation vs Line Voltage and Load Current @25°C**

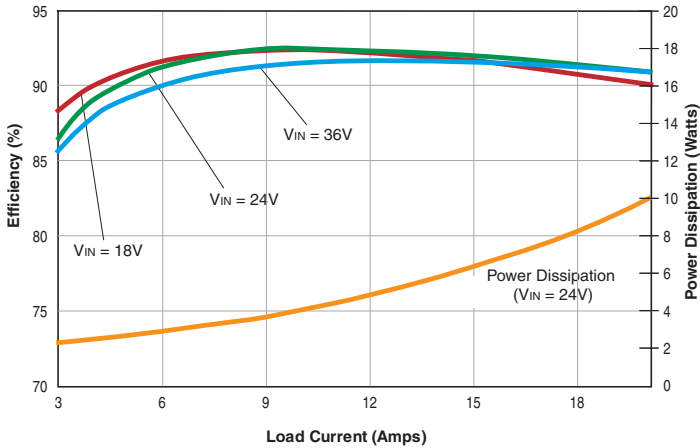

**UCH-5/30-D48 Efficiency and Power Dissipation vs Line Voltage and Load Current @25°C**

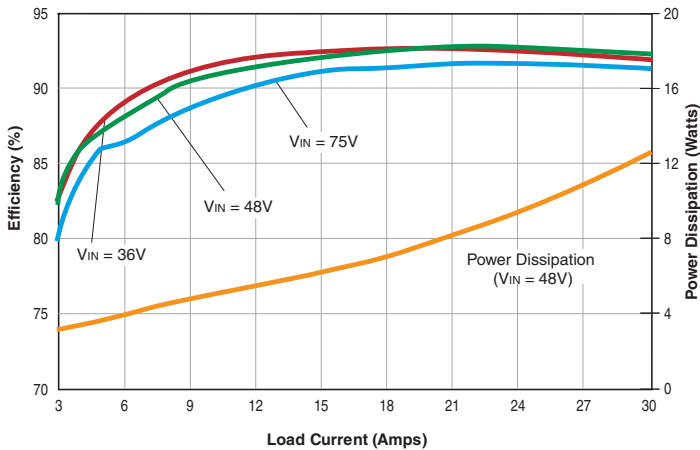

**UCH-12/4.2-D48 Efficiency and Power Dissipation vs Line Voltage and Load Current @25°C**

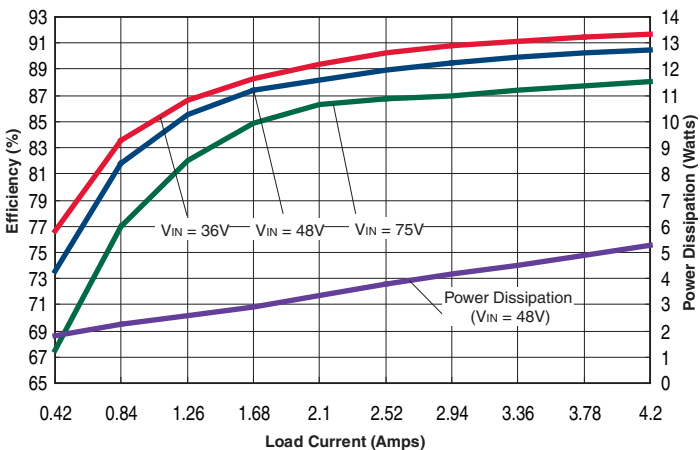

**UCH-5/20-D24 Maximum Current Temperature Derating (at sea level)**  
No baseplate,  $V_{IN} = 24V$ , transverse airflow

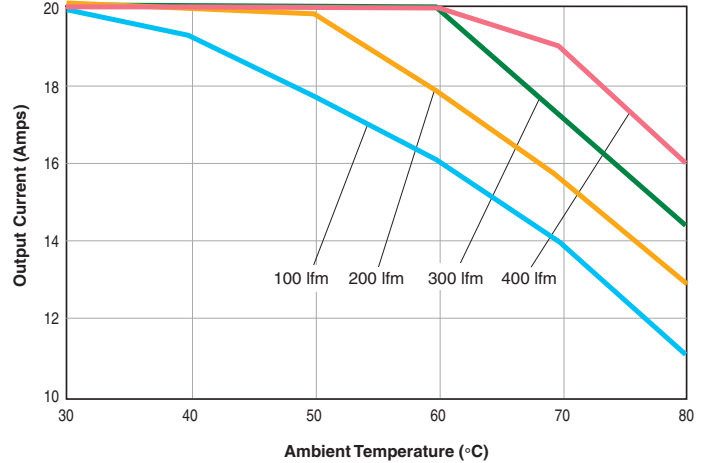

**UCH-5/30-D48 Maximum Current Temperature Derating (at sea level)**  
No baseplate,  $V_{IN} = 48V$ , transverse airflow

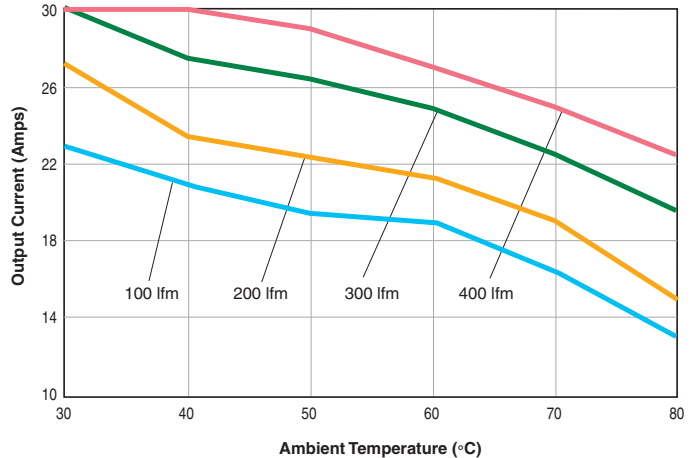

**UCH-12/4.2-D48 Maximum Current Temperature Derating at sea level**  
( $V_{IN} = 48V$ , airflow direction from  $V_{IN}$  to  $V_{OUT}$ , no baseplate)

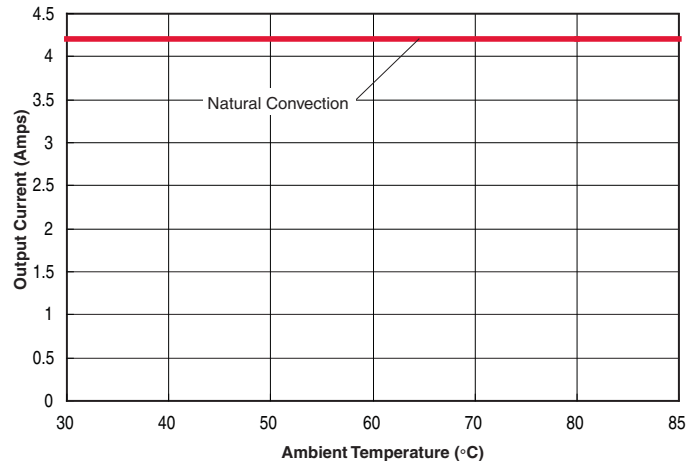

## TYPICAL PERFORMANCE DATA

**UCH-12/12.5-D48 Efficiency and Power Dissipation vs Line Voltage and Load Current @25°C**

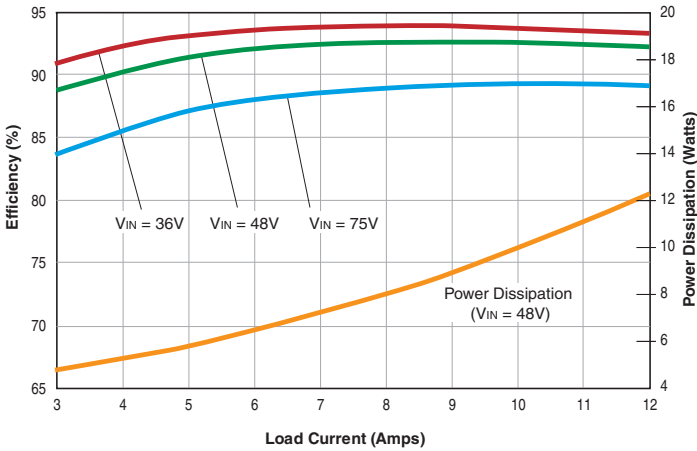

**UCH-15/6.7-D48 Efficiency and Power Dissipation vs Line Voltage and Load Current @25°C**

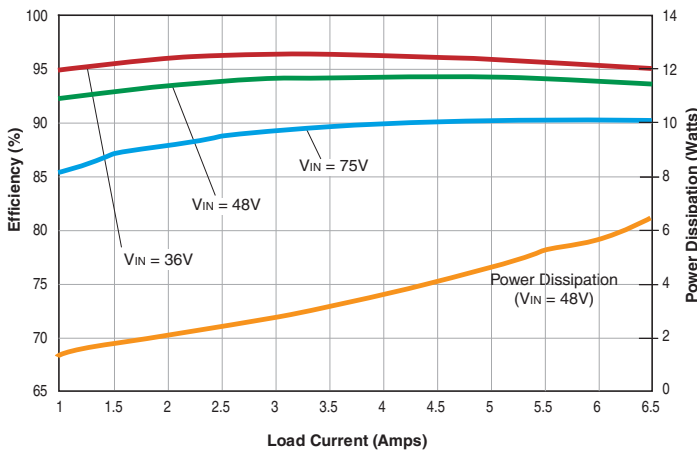

**UCH-12/12.5-D48 Maximum Current Temperature Derating (at sea level)**  
No baseplate, VIN = 48V, transverse airflow

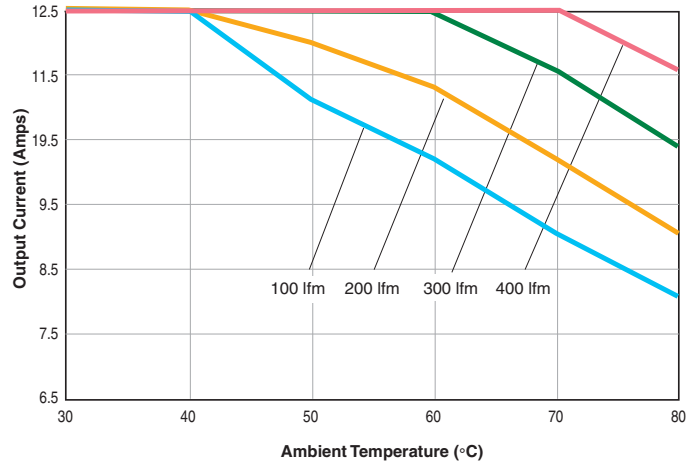

**UCH-15/6.7-D48 Maximum Current Temperature Derating (at sea level)**  
No baseplate, VIN = 48V, transverse airflow

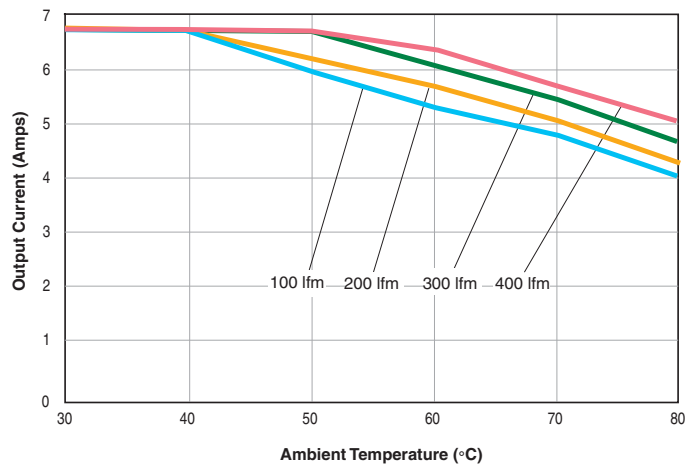

## MECHANICAL SPECIFICATIONS

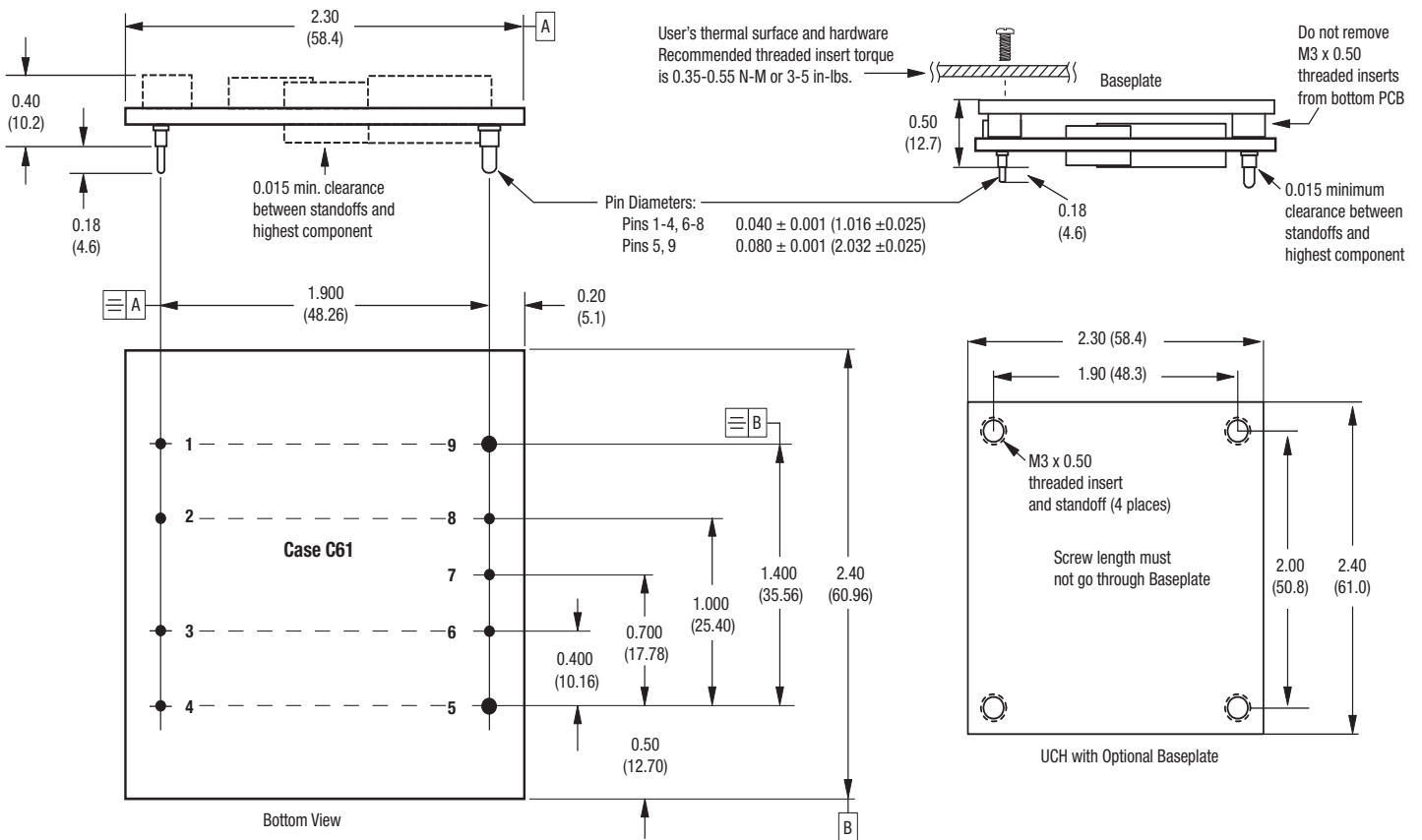

Standard pin length is shown. Please refer to the Part Number Structure for special order pin lengths.

### INPUT/OUTPUT CONNECTIONS

Pin	Function P17
1	-Input
2	Case
3	On/Off Control
4	+Input
5	+Output
6	+Sense
7	Trim
8	-Sense
9	-Output

Pin 2 may be removed under special order. The case pin 2 is normally only used in combination with the baseplate. Please contact Murata Power Solutions.

Dimensions are in inches (mm) shown for ref. only.

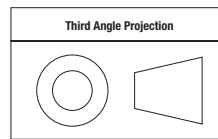

Tolerances (unless otherwise specified):  
 .XX ± 0.02 (0.5)  
 .XXX ± 0.010 (0.25)  
 Angles ± 2°

Components are shown for reference only.

TECHNICAL NOTES

### Input Fusing

Certain applications and/or safety agencies may require fuses at the inputs of power conversion components. Fuses should also be used when there is the possibility of sustained input voltage reversal which is not current-limited. For greatest safety, we recommend a fast blow fuse installed in the ungrounded input supply line.

The installer must observe all relevant safety standards and regulations. For safety agency approvals, install the converter in compliance with the end-user safety standard, i.e. IEC/EN/UL 60950-1.

### Input Reverse-Polarity Protection

If the input voltage polarity is reversed, an internal body diode will become forward biased and likely draw excessive current from the power source. If this source is not current-limited or the circuit appropriately fused, it could cause permanent damage to the converter. **Please be sure to install a properly-rated external input fuse** (see Specifications).

### Input Under-Voltage Shutdown and Start-Up Threshold

Under normal start-up conditions, converters will not begin to regulate properly until the ramping-up input voltage exceeds and remains at the Start-Up Threshold Voltage (see Specifications). Once operating, converters will not turn off until the input voltage drops below the Under-Voltage Shutdown Limit. Subsequent restart will not occur until the input voltage rises again above the Start-Up Threshold. This built-in hysteresis prevents any unstable on/off operation at a single input voltage.

Users should be aware however of input sources near the Under-Voltage Shutdown whose voltage decays as input current is consumed (such as capacitor inputs), the converter shuts off and then restarts as the external capacitor recharges. Such situations could oscillate. To prevent this, make sure the operating input voltage is well above the UV Shutdown voltage AT ALL TIMES.

### Start-Up Time

Assuming that the output current is set at the rated maximum, the  $V_{in}$  to  $V_{out}$  Start-Up Time (see Specifications) is the time interval between the point when the ramping input voltage crosses the Start-Up Threshold and the fully loaded regulated output voltage enters and remains within its specified accuracy band. Actual measured times will vary with input source impedance, external input capacitance, input voltage slew rate and final value of the input voltage as it appears at the converter.

These converters include a soft start circuit to moderate the duty cycle of its PWM controller at power up, thereby limiting the input inrush current.

The On/Off Remote Control interval from On command to  $V_{out}$  regulated assumes that the converter already has its input voltage stabilized above the Start-Up Threshold before the On command. The interval is measured from the On command until the output enters and remains within its specified accuracy band. The specification assumes that the output is fully loaded at maximum rated current. Similar conditions apply to the On to  $V_{out}$  regulated specification such as external load capacitance and soft start circuitry.

### Input Source Impedance

These converters will operate to specifications without external components, assuming that the source voltage has very low impedance and reasonable input voltage regulation. Since real-world voltage sources have finite impedance, performance is improved by adding external filter components. Sometimes only a small ceramic capacitor is sufficient. Since it is difficult to totally characterize all applications, some experimentation may be needed. Note that external input capacitors must accept high speed switching currents.

Because of the switching nature of DC/DC converters, the input of these converters must be driven from a source with both low AC impedance and adequate DC input regulation. Performance will degrade with increasing input inductance. Excessive input inductance may inhibit operation. The DC input regulation specifies that the input voltage, once operating, must never degrade below the Shut-Down Threshold under all load conditions. Be sure to use adequate trace sizes and mount components close to the converter.

### I/O Filtering, Input Ripple Current and Output Noise

All models in this converter series are tested and specified for input reflected ripple current and output noise using designated external input/output components, circuits and layout as shown in the figures below. External input capacitors ( $C_{in}$  in the figure) serve primarily as energy storage elements, minimizing line voltage variations caused by transient IR drops in the input conductors. Users should select input capacitors for bulk capacitance (at appropriate frequencies), low ESR and high RMS ripple current ratings. In the figure below, the  $C_{bus}$  and  $L_{bus}$  components simulate a typical DC voltage bus. Your specific system configuration may require additional considerations. Please note that the values of  $C_{in}$ ,  $L_{bus}$  and  $C_{bus}$  will vary according to the specific converter model.

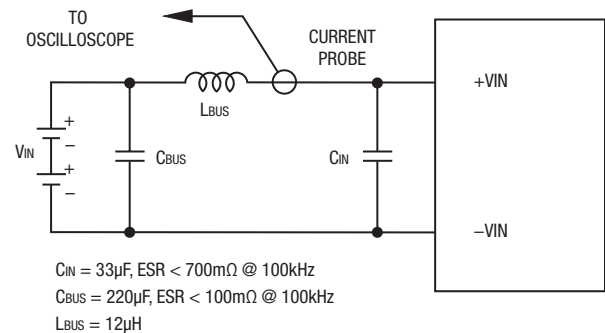

**Figure 2. Measuring Input Ripple Current**

In critical applications, output ripple and noise (also referred to as periodic and random deviations or PARD) may be reduced by adding filter elements such as multiple external capacitors. Be sure to calculate component temperature rise from reflected AC current dissipated inside capacitor ESR.

In the figure, the two copper strips simulate real-world printed circuit impedances between the power supply and its load. In order to minimize circuit errors and standardize tests between units, scope measurements should be made using BNC connectors or the probe ground should not exceed one half inch and soldered directly to the fixture.

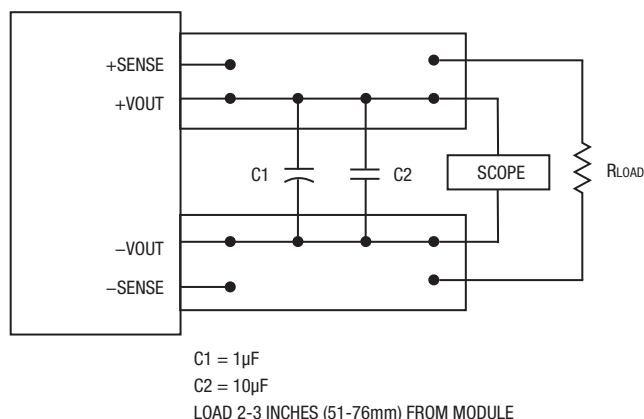

**Figure 3. Measuring Output Ripple and Noise (PARD)**

### Floating Outputs

Since these are isolated DC/DC converters, their outputs are “floating” with respect to their input. The essential feature of such isolation is ideal ZERO CURRENT FLOW between input and output. Real-world converters however do exhibit tiny leakage currents between input and output (see Specifications). These leakages consist of both an AC stray capacitance coupling component and a DC leakage resistance. When using the isolation feature, do not allow the isolation voltage to exceed specifications. Otherwise the converter may be damaged. Designers will normally use the negative output (-Output) as the ground return of the load circuit. You can however use the positive output (+Output) as the ground return to effectively reverse the output polarity.

### Minimum Output Loading Requirements

All models regulate within specification and are stable under no load to full load conditions. Operation under no load might however slightly increase output ripple and noise.

### Thermal Shutdown

To prevent many over temperature problems and damage, these converters include thermal shutdown circuitry. If environmental conditions cause the temperature of the DC/DC’s to rise above the Operating Temperature Range up to the shutdown temperature, an on-board electronic temperature sensor will power down the unit. When the temperature decreases below the turn-on threshold, the converter will automatically restart. There is a small amount of hysteresis to prevent rapid on/off cycling. The temperature sensor is typically located adjacent to the switching controller, approximately in the center of the unit. See the Performance and Functional Specifications.

**CAUTION:** If you operate too close to the thermal limits, the converter may shut down suddenly without warning. Be sure to thoroughly test your application to avoid unplanned thermal shutdown.

### Temperature Derating Curves

The graphs in this data sheet illustrate typical operation under a variety of conditions. The Derating curves show the maximum continuous ambient air temperature and decreasing maximum output current which is acceptable under increasing forced airflow measured in Linear Feet per Minute (“LFM”). Note that these are AVERAGE measurements. The converter will accept brief increases in current or reduced airflow as long as the average is not exceeded.

Note that the temperatures are of the ambient airflow, not the converter itself which is obviously running at higher temperature than the outside air. Also note that very low flow rates (below about 25 LFM) are similar to “natural convection,” that is, not using fan-forced airflow.

Murata Power Solutions makes Characterization measurements in a closed cycle wind tunnel with calibrated airflow. We use both thermocouples and an infrared camera system to observe thermal performance. As a practical matter, it is quite difficult to insert an anemometer to precisely measure airflow in most applications. Sometimes it is possible to estimate the effective airflow if you thoroughly understand the enclosure geometry, entry/exit orifice areas and the fan flowrate specifications.

**CAUTION:** If you routinely or accidentally exceed these Derating guidelines, the converter may have an unplanned Over Temperature shut down. Also, these graphs are all collected at slightly above Sea Level altitude. Be sure to reduce the derating for higher density altitude.

### Output Overvoltage Protection

This converter monitors its output voltage for an over-voltage condition. If the output exceeds OVP limits, the sensing circuit will power down the unit, and the output voltage will decrease. After a time-out period, the PWM will automatically attempt to restart, causing the output voltage to ramp up to its rated value. It is not necessary to power down and reset the converter for the automatic OVP-recovery restart.

If the fault condition persists and the output voltage climbs to excessive levels, the OVP circuitry will initiate another shutdown cycle. This on/off cycling is referred to as “hiccup” mode. It safely tests full current rated output voltage without damaging the converter.

### Output Fusing

The converter is extensively protected against current, voltage and temperature extremes. However your output application circuit may need additional protection. In the extremely unlikely event of output circuit failure, excessive voltage could be applied to your circuit. Consider using an appropriate fuse in series with the output.

### Output Current Limiting

As soon as the output current increases to approximately 125% to 150% of its maximum rated value, the DC/DC converter will enter a current-limiting mode. The output voltage will decrease proportionally with increases in output current, thereby maintaining a somewhat constant power output. This is also commonly referred to as power limiting.

Current limiting inception is defined as the point at which full power falls below the rated tolerance. See the Performance/Functional Specifications. Note particularly that the output current may briefly rise above its rated value in normal operation as long as the average output power is not exceeded. This enhances reliability and continued operation of your application. If the output current is too high, the converter will enter the short circuit condition.

### Output Short Circuit Condition

When a converter is in current-limit mode, the output voltage will drop as the output current demand increases. If the output voltage drops too low (approximately 98% of nominal output voltage for most models), the magnetically

coupled voltage used to develop primary side voltages will also drop, thereby shutting down the PWM controller. Following a time-out period, the PWM will restart, causing the output voltage to begin ramping up to its appropriate value. If the short-circuit condition persists, another shutdown cycle will initiate. This rapid on/off cycling is called “hiccup mode”. The hiccup cycling reduces the average output current, thereby preventing excessive internal temperatures and/or component damage. A short circuit can be tolerated indefinitely.

The “hiccup” system differs from older latching short circuit systems because you do not have to power down the converter to make it restart. The system will automatically restore operation as soon as the short circuit condition is removed.

### Remote Sense Input

Use the Sense inputs with caution. Sense is normally connected **at the load**. Sense inputs compensate for output voltage inaccuracy delivered at the load. This is done by correcting IR voltage drops along the output wiring and the current carrying capacity of PC board etc. This output drop (the difference between Sense and Vout when measured at the converter) should not be allowed to exceed 0.5V. Consider using heavier wire if this drop is excessive. Sense inputs also improve the stability of the converter and load system by optimizing the control loop phase margin.

Note: The Sense input and power Vout lines are internally connected through low value resistors to their respective polarities so that the converter can operate without external connection to the Sense. Nevertheless, if the Sense function is not used for remote regulation, the user should connect +Sense to +Vout and –Sense to –Vout at the converter pins.

The remote Sense lines carry very little current. They are also capacitively coupled to the output lines and therefore are in the feedback control loop to regulate and stabilize the output. As such, they are not low impedance inputs and must be treated with care in PC board layouts. Sense lines on the PCB should run adjacent to DC signals, preferably Ground. In cables and discrete wiring, use twisted pair, shielded tubing or similar techniques.

Any long, distributed wiring and/or significant inductance introduced into the Sense control loop can adversely affect overall system stability. If in doubt, test your applications by observing the converter’s output transient response during step loads. There should not be any appreciable ringing or oscillation. You may also adjust the output trim slightly to compensate for voltage loss in any external filter elements. Do not exceed maximum power ratings.

Please observe Sense inputs tolerance to avoid improper operation:

$$[V_{out(+)} - V_{out(-)}] - [Sense(+)-Sense(-)] \leq 10\% \text{ of } V_{out}$$

Output overvoltage protection is monitored at the output voltage pin, not the Sense pin. Therefore excessive voltage differences between Vout and Sense together with trim adjustment of the output can cause the overvoltage protection circuit to activate and shut down the output.

Power derating of the converter is based on the combination of maximum output current and the highest output voltage. Therefore the designer must insure:

$$(V_{out \text{ at pins}}) \times (I_{out}) \leq (\text{Max. rated output power})$$

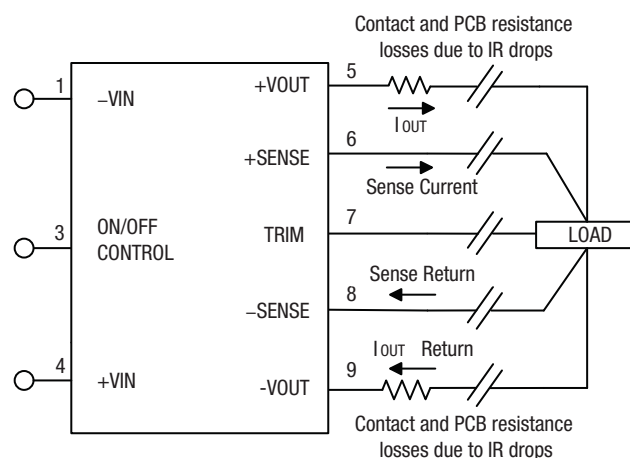

Figure 4. Remote Sense Circuit Configuration

### Trimming the Output Voltage

The Trim input to the converter allows the user to adjust the output voltage over the rated trim range (please refer to the Specifications). In the trim equations and circuit diagrams that follow, trim adjustments use either a trimpot or a single fixed resistor connected between the Trim input and either the +Sense or –Sense terminals. (On some converters, an external user-supplied precision DC voltage may also be used for trimming). Trimming resistors should have a low temperature coefficient ( $\pm 100$  ppm/deg.C or less) and be mounted close to the converter. Keep leads short. If the trim function is not used, leave the trim unconnected. With no trim, the converter will exhibit its specified output voltage accuracy.

There are two CAUTIONS to be aware of for the Trim input:

**CAUTION:** To avoid unplanned power down cycles, do not exceed EITHER the maximum output voltage OR the maximum output power when setting the trim. Be particularly careful with a trimpot. If the output voltage is excessive, the OVP circuit may inadvertently shut down the converter. If the maximum power is exceeded, the converter may enter current limiting. If the power is exceeded for an extended period, the converter may overheat and encounter overtemperature shut down.

**CAUTION:** Be careful of external electrical noise. The Trim input is a sensitive input to the converter’s feedback control loop. Excessive electrical noise may cause instability or oscillation. Keep external connections short to the Trim input. Use shielding if needed.



## Trim Equations

### Trim Down

Connect trim resistor between trim pin and -Sense

$$R_{\text{TrimDn}} \text{ (k}\Omega\text{)} = \frac{1}{\Delta} - 2$$

Where,

$$\Delta = \frac{V_{\text{NOMINAL}} - V_{\text{OUT}}}{V_{\text{NOMINAL}}}$$

### Trim Up

Connect trim resistor between trim pin and +Sense

$$R_{\text{TrimUp}} \text{ (k}\Omega\text{)} = \frac{V_{\text{NOMINAL}} \times (1 + \Delta)}{1.225 \times \Delta} - \frac{1}{\Delta} - 2$$

Where,

$$\Delta = \frac{V_{\text{OUT}} - V_{\text{NOMINAL}}}{V_{\text{NOMINAL}}}$$

$V_{\text{NOM}}$  is the nominal, untrimmed output voltage.

$V_{\text{OUT}}$  is the desired new output voltage.

Do not exceed the specified trim range or maximum power ratings when adjusting trim. Use 1% precision resistors mounted close to the converter on short leads.

## Trim Circuits

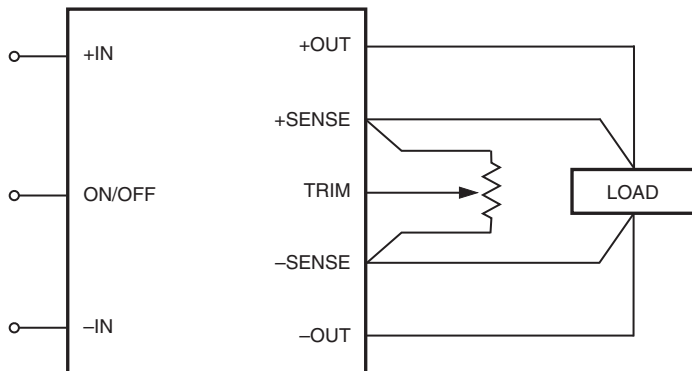

Figure 5. Trim Connections Using A Trimpot

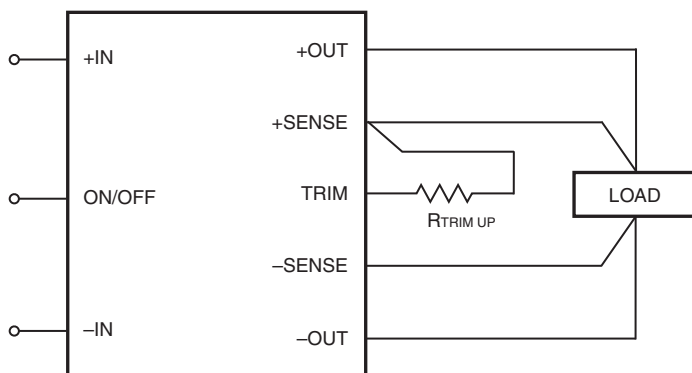

Figure 6. Trim Connections to Increase Output Voltages

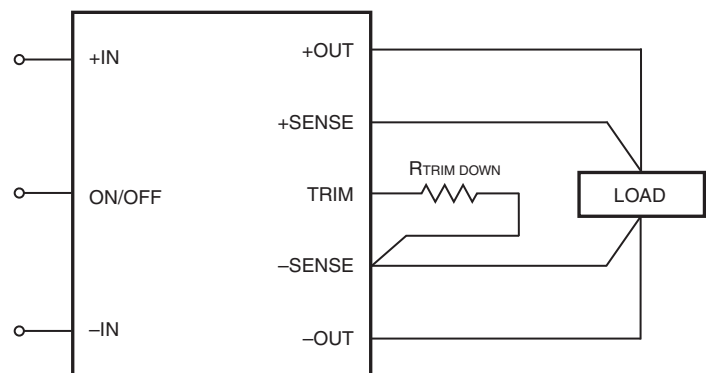

Figure 7. Trim Connections to Decrease Output Voltages

## Remote On/Off Control

On the input side, a remote On/Off Control can be ordered with either logic type.

**Positive:** Standard models are enabled when the On/Off pin is left open or is pulled high to +Vin with respect to –Vin. An internal bias current causes the open pin to rise to approximately +15V. Some models will also turn on at lower intermediate voltages (see Specifications). Positive-logic devices are disabled when the On/Off is grounded or brought to within a low voltage (see Specifications) with respect to –Vin.

**Negative:** Optional negative-logic devices are on (enabled) when the On/Off is grounded or brought to within a low voltage (see Specifications) with respect to –Vin. The device is off (disabled) when the On/Off is left open or is pulled high to approximately +15V with respect to –Vin.

Dynamic control of the On/Off function should be able to sink appropriate signal current when brought low and withstand appropriate voltage when brought high. Be aware too that there is a finite time in milliseconds (see Specifications) between the time of On/Off Control activation and stable, regulated output. This time will vary slightly with output load type and current and input conditions.

There are several CAUTIONs for the On/Off Control:

**CAUTION:** While it is possible to control the On/Off with external logic if you carefully observe the voltage levels, the preferred circuit is either an open drain/open collector transistor, a switch or a relay (which can thereupon be controlled by logic) returned to negative Vin.

**CAUTION:** Do not apply voltages to the On/Off pin when there is no input power voltage. Otherwise the converter may be permanently damaged.

## Output Capacitive Load

These converters do not require external capacitance added to achieve rated specifications. Users should only consider adding capacitance to reduce switching noise and/or to handle spike current step loads. Install only enough capacitance to achieve noise objectives. Excess external capacitance may cause regulation problems, slower transient response and possible instability. Proper wiring of the Sense inputs will improve these factors under capacitive load.

The maximum rated output capacitance and ESR specification is given for a capacitor installed immediately adjacent to the converter. Any extended output wiring or smaller wire gauge or less ground plane may tolerate somewhat higher capacitance. Also, capacitors with higher ESR may use a larger capacitance.

## Product Adaptations

Murata Power Solutions offers several variations of our core product family. These products are available under scheduled quantity orders and may also include separate manufacturing documentation from a mutually-agreeable Product Specification. Since these product adaptations largely share a common parts list, similar specifications and test methods with their root products, they are provided at excellent costs and delivery. Please contact MPS for details.

As of this date, the following products are available:

UCH-3.3/30-D48NBHL2-Y

UCH-5/10-D48NBHL2-Y

UCH-3.3/15-D48NBHL2-Y

UCH-3.3/35-D24NBHL2-Y

These are all negative On/Off logic, baseplate installed, conformal coating added, 3.68mm pin length, and RoHS-5 hazardous substance compliance (with lead).

