



<b>Table of Contents</b>	<b>Page</b>
Description	3
Qualification Information	5
Absolute Maximum Ratings	6
Recommended Operating Conditions	6
Electrical Characteristics	7
Functional Block Diagram	8
Input/Output Pin Equivalent Circuit Diagram	9
Lead Definitions	10
Lead Assignments	10
Application Information and Additional Details	12
Package Details	17
Tape and Reel Details	18
Part Marking Information	19
Ordering Information	20

## Description

The IRS254(01,11) are high voltage, high frequency buck control ICs for constant LED current regulation. They incorporate a continuous mode time-delayed hysteretic buck regulator to directly control the average load current, using an accurate on-chip bandgap voltage reference. These parts directly replace the IRS2540 and IRS2541 with improved latch up immunity.

The application is inherently protected against short circuit conditions, with the ability to easily add open-circuit protection. An external high-side bootstrap circuit drives the buck switching element at high frequencies. A low-side driver is also provided for synchronous rectifier designs. All functions are realized within a simple 8 pin DIP or SOIC package.

**Alternate application circuit using a single MOSFET**

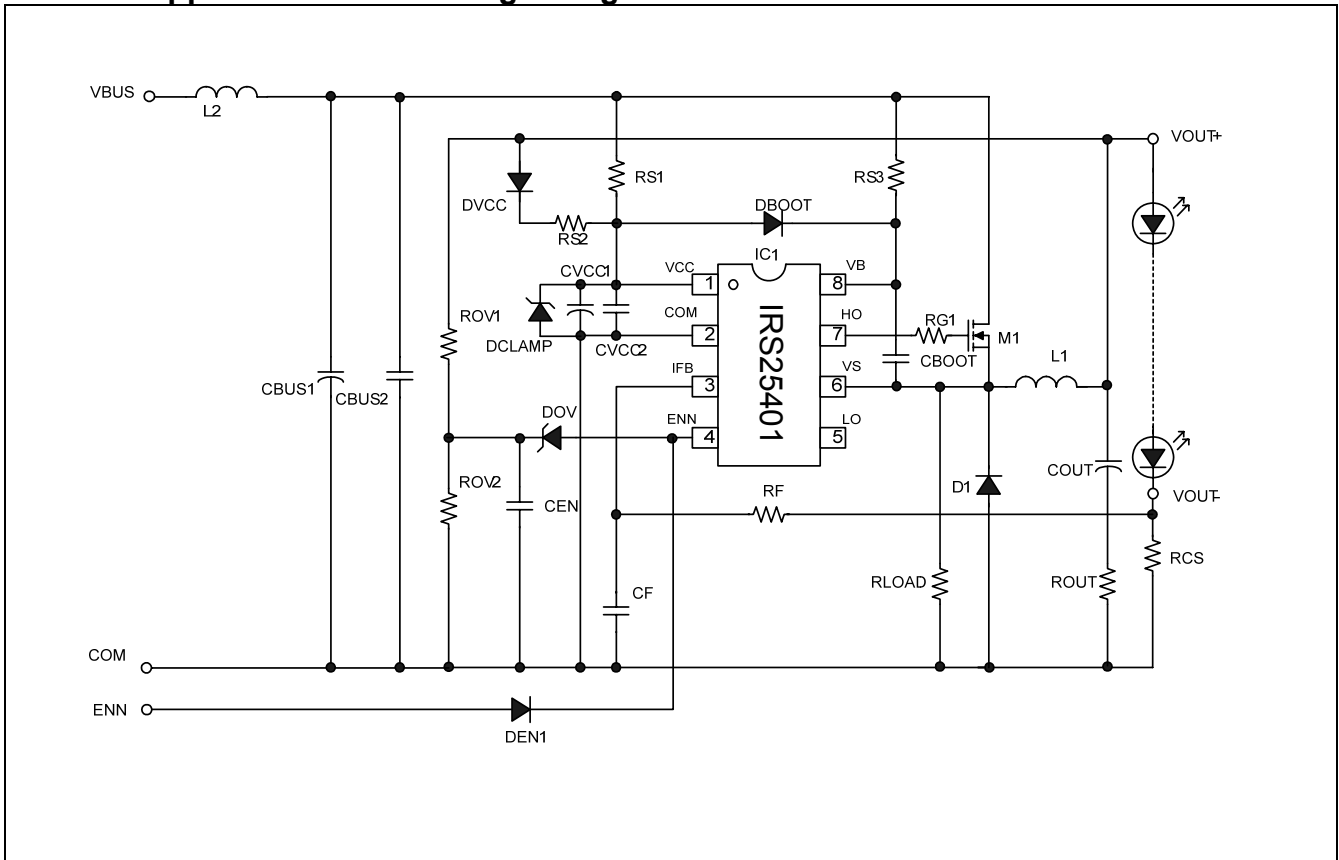

**Qualification Information<sup>†</sup>**

Qualification Level		Industrial <sup>††</sup>	
		Comments: This family of ICs has passed JEDEC's Industrial qualification. IR's Consumer qualification level is granted by extension of the higher Industrial level.	
Moisture Sensitivity Level		SOIC8	MSL2 <sup>†††</sup> 260°C (per IPC/JEDEC J-STD-020)
		PDIP8	Not applicable (non-surface mount package style))
ESD	Machine Model	Class B (per JEDEC standard JESD22-A115)	
	Human Body Model	Class 1C (per EIA/JEDEC standard EIA/JESD22-A114)	
IC Latch-Up Test		Class I, Level A (per JESD78)	
RoHS Compliant		Yes	

† Qualification standards can be found at International Rectifier's web site <http://www.irf.com/>

†† Higher qualification ratings may be available should the user have such requirements. Please contact your International Rectifier sales representative for further information.

††† Higher MSL ratings may be available for the specific package types listed here. Please contact your International Rectifier sales representative for further information.

### Absolute Maximum Ratings

Absolute maximum ratings indicate sustained limits beyond which damage to the device may occur. All voltage parameters are absolute voltages referenced to COM, all currents are defined positive into any lead. The thermal resistance and power dissipation ratings are measured under board mounted and still air conditions.

Symbol	Definition		Min	Max	Units
V <sub>B</sub>	High-side floating well supply voltage	IRS25401	-0.3	225	V
		IRS25411	-0.3	625	
V <sub>S</sub>	High-side floating well supply return voltage		V <sub>B</sub> + 0.3	V <sub>B</sub> + 0.3	
V <sub>HO</sub>	Floating gate drive output voltage		V <sub>S</sub> - 0.3	V <sub>B</sub> + 0.3	
V <sub>LO</sub>	Low-side output voltage		-0.3	V <sub>CC</sub> + 0.3	
V <sub>IFB</sub>	Feedback voltage		-0.3	V <sub>CC</sub> + 0.3	
V <sub>ENN</sub>	Enable voltage		-0.3	V <sub>CC</sub> + 0.3	
I <sub>CC</sub>	Supply current (†)		-20	20	
dV/dt	Allowable offset voltage slew rate		-50	50	V/ns
P <sub>D</sub>	Package power dissipation @ T <sub>A</sub> ≤ +25 °C P <sub>D</sub> = (T <sub>JMAX</sub> - T <sub>A</sub> ) / R <sub>THJA</sub>	(8-Pin DIP)	---	1	W
		(8-Pin SOIC)	---	0.625	
R <sub>ΘJA</sub>	Thermal resistance, junction to ambient	(8-Pin DIP)	---	125	°C/W
		(8-Pin SOIC)	---	200	
T <sub>J</sub>	Junction temperature		-55	150	°C
T <sub>S</sub>	Storage temperature		-55	150	
T <sub>L</sub>	Lead temperature (soldering, 10 seconds)		---	300	

† : This IC contains a zener clamp structure between the chip V<sub>CC</sub> and COM, with a nominal breakdown voltage of 15.6 V. Please note that this supply pin should not be driven by a low impedance DC power source greater than V<sub>CLAMP</sub> specified in the electrical characteristics section.

### Recommended Operating Conditions

For proper operation the device should be used within recommended conditions.

Symbol	Definition		Min	Max	Units
V <sub>BS</sub>	High-side floating supply voltage		V <sub>CC</sub> - 0.7	V <sub>CLAMP</sub>	
V <sub>S</sub>	Steady state high-side floating supply offset voltage	IRS25401	-1	200	V
		IRS25411	-1	600	
V <sub>CC</sub>	Supply voltage		V <sub>CCUV+</sub>	V <sub>CLAMP</sub>	
I <sub>CC</sub>	Supply current		-Note 2	10	
T <sub>J</sub>	Junction temperature		-25	125	

†† : Sufficient current should be supplied to V<sub>CC</sub> to keep the internal 15.6 V zener regulating at V<sub>CLAMP</sub>.

**Electrical Characteristics**

$V_{CC} = V_{BS} = V_{BIAS} = 14\text{ V} \pm 0.25\text{ V}$ ,  $C_{LO} = C_{HO} = 1000\text{ pF}$ ,  $C_{VCC} = C_{VBS} = 0.1\text{ }\mu\text{F}$ ,  $T_A = 25\text{ }^\circ\text{C}$  unless otherwise specified.

Symbol	Definition	Min	Typ	Max	Units	Test Conditions
<b>Supply Characteristics</b>						
$V_{CCUV+}$	$V_{CC}$ supply undervoltage positive going threshold	8.0	9.0	10.0	V	$V_{CC}$ rising from 0 V
$V_{CCUV-}$	$V_{CC}$ supply undervoltage negative going threshold	6.5	7.5	8.5		$V_{CC}$ falling from 14 V
$V_{UVHYS}$	$V_{CC}$ supply undervoltage lockout hysteresis	1.0	1.2	2.0		
$I_{QCCUV}$	UVLO mode quiescent current	---	50	150	$\mu\text{A}$	$V_{CC} = 6\text{ V}$
$I_{QCCENN}$	Disabled mode quiescent current	---	1.0	2.0	mA	$EN > V_{ENTH+}$
$I_{QCC}$	Quiescent $V_{CC}$ supply current	---	1.0	2.0		$I_{FB} = 1\text{ V}$
$I_{CC50k}$	$V_{CC}$ supply current, $f = 50\text{ kHz}$	---	2.0	3.0		Duty Cycle = 50% $f = 50\text{ kHz}$
$V_{CLAMP}$	$V_{CC}$ zener clamp voltage	14.6	15.6	16.6	V	$I_{CC} = 10\text{ mA}$
<b>Floating Supply Characteristics</b>						
$I_{QBS0}$	Quiescent $V_{BS}$ supply current	---	0.05	1.0	mA	$V_{HO} = V_S$
$I_{QBS1}$	Quiescent $V_{BS}$ supply current	---	1.0	2.0		$I_{FB} = 0\text{ V}$
$V_{BSUV+}$	$V_{BS}$ supply undervoltage positive going threshold	6.5	7.5	8.5	V	
$V_{BSUV-}$	$V_{BS}$ supply undervoltage negative going threshold	6.0	7.0	8.0		
$I_{LK}$	Offset supply leakage current	---	1	50	$\mu\text{A}$	IRS25401: $V_B = V_S = 200\text{ V}$ IRS25411: $V_B = V_S = 600\text{ V}$
$V_{CLAMPHS}$	$V_{BS}$ high side zener clamp voltage	24.4	26.0	27.6	V	$I_{CC} = 10\text{ mA}$
<b>Current Control Operation</b>						
$V_{ENNTH+}$	ENN pin positive threshold	2.5	2.7	3.0	V	
$V_{ENNTH-}$	ENN pin negative threshold	1.7	2.0	2.3		
$V_{0.5}$	0.5 V voltage reference (die level test)	490	500	510	mV	
$V_{IFBTH}$	IFB pin threshold	455	500	540		
f	Maximum frequency	---	500	---	kHz	
<b>Gate Driver Output Characteristics</b>						
$V_{OL}$	Low level output voltage (HO or LO)	---	COM	---	V	
$V_{OH}$	High level output voltage (HO or LO)	---	$V_{CC}$	---		
$t_r$	Turn-on rise time	---	50	120	ns	
$t_f$	Turn-off fall time	---	30	50		
$I_{O+/-}$	Output source/sink short circuit pulsed current	---	0.5/0.7	---	A	
DT	Deadtime	---	140	---	ns	$I_{FB} = 50\text{ kHz}$ square wave, 200 mV pk-pk DC offset = 400 mV Duty Cycle = 50%
$t_{LO,ON}$	Delay between $V_{IFB} > V_{IFBTH}$ and LO turn-on	---	320	---		
$t_{LO,OFF}$	Delay between $V_{IFB} < V_{IFBTH}$ and LO turn-off	---	180	---		
$t_{HO,ON}$	Delay between $V_{IFB} < V_{IFBTH}$ and HO turn-on	---	320	---		
$t_{HO,OFF}$	Delay between $V_{IFB} > V_{IFBTH}$ and HO turn-off	---	180	---		
<b>Watchdog timer</b>						
$t_{WD}$	Watchdog timer period	---	20	---	$\mu\text{s}$	$I_{FB} = 1\text{ V}$
$P_{WWD}$	LO pulse width	---	1.0	---		

**Functional Block Diagram**

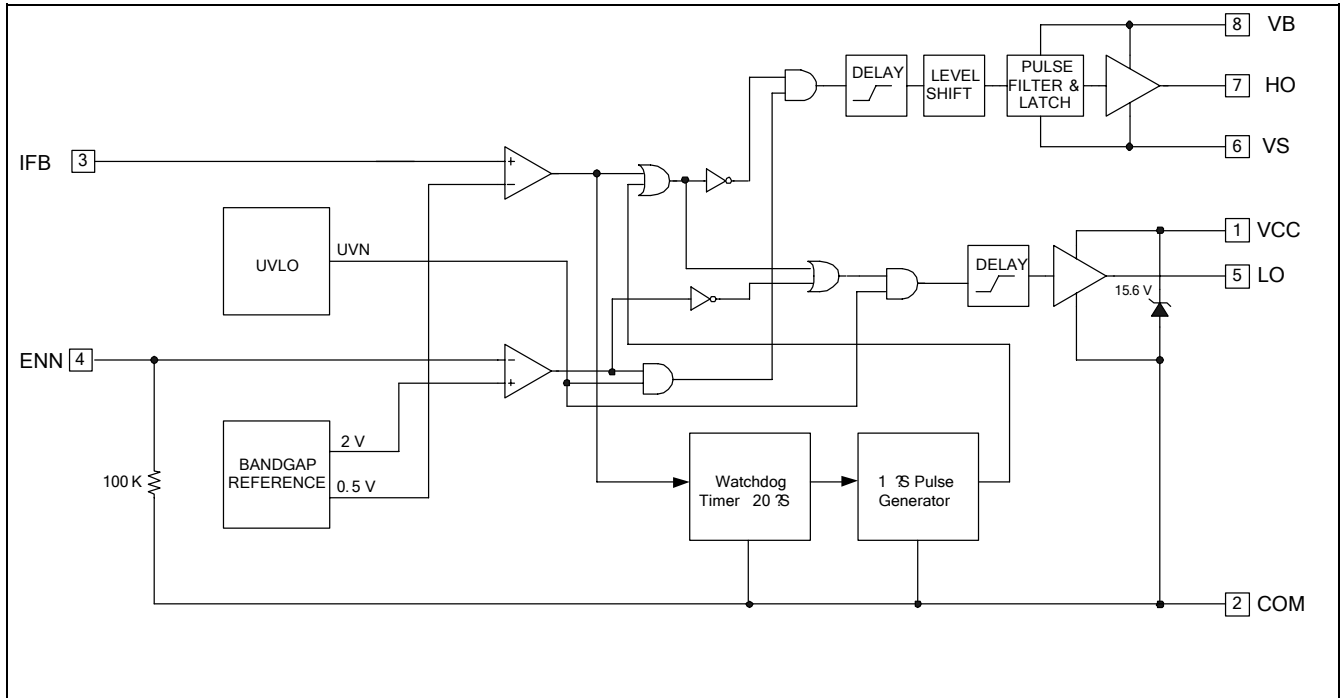

Values in block diagram are typical values



**Input/Output Pin Equivalent Circuit Diagrams: IRS25401/IRS25411**

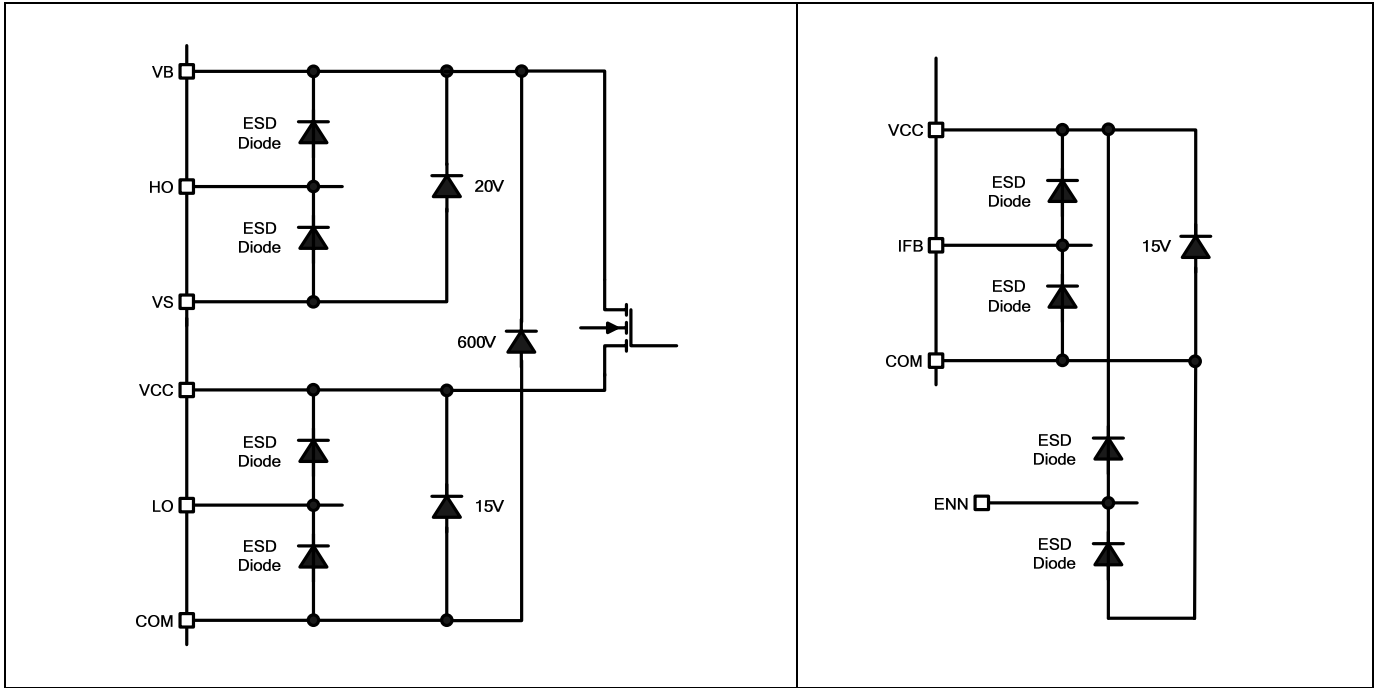

**Lead Definitions**

PIN #	Symbol	Description
1	VCC	Supply voltage
2	COM	IC power & signal ground
3	IFB	Current feedback
4	ENN	Disable outputs (LO=High, HO=Low)
5	LO	Low-side gate driver output
6	VS	High-side floating return
7	HO	High-side gate driver output
8	VB	High-side gate driver floating supply

**Lead Assignments**

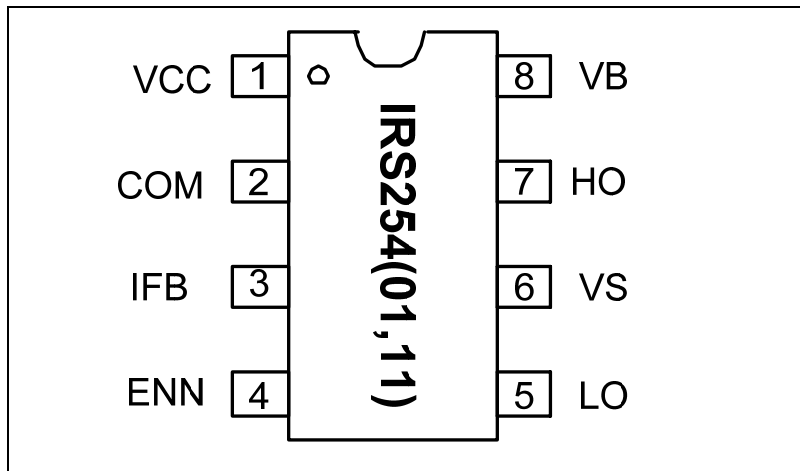

**State Diagram**

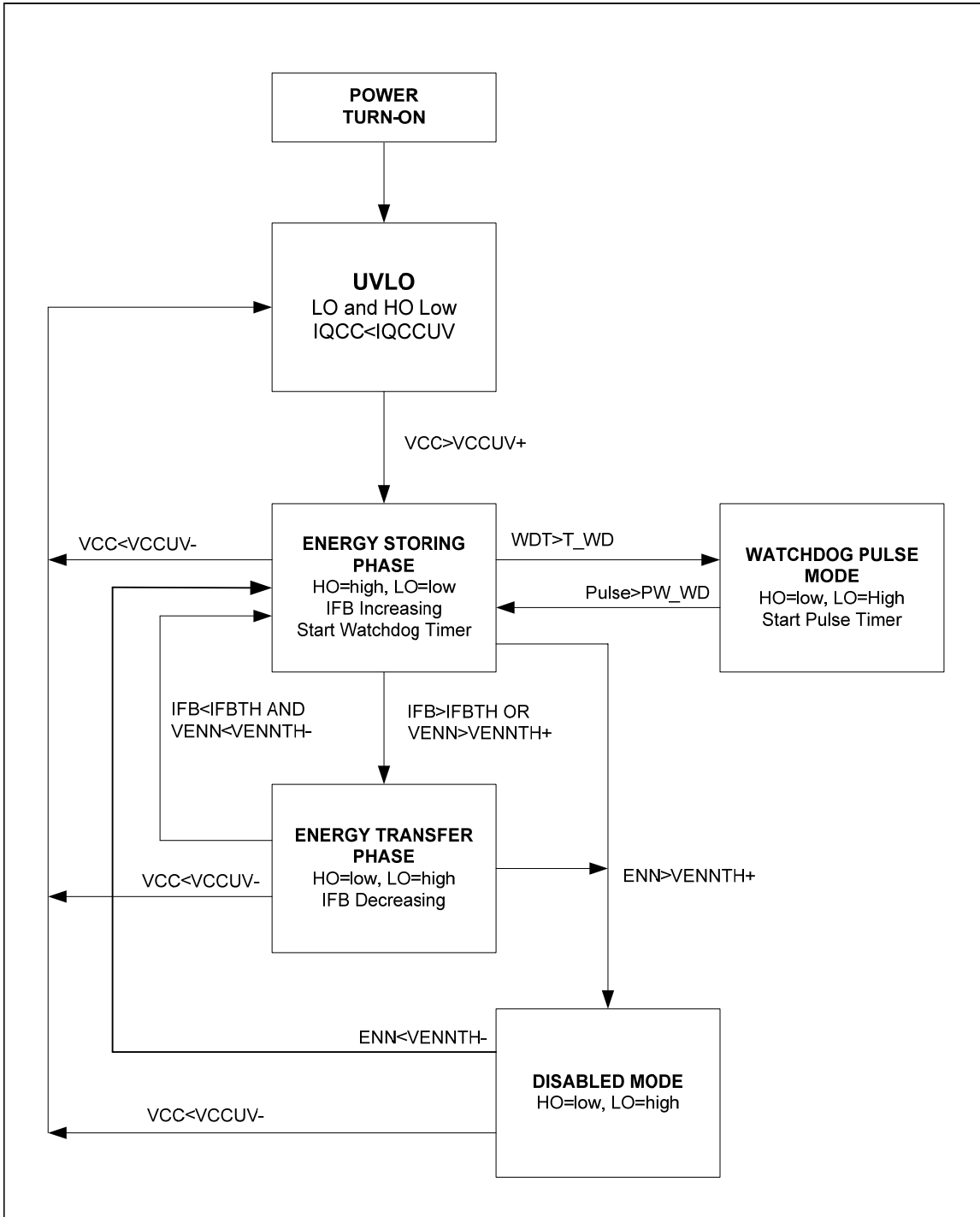

**Application Information and Additional Details**

**Operating Mode**

The IRS254(01,11) operates as a time-delayed hysteretic buck controller. During normal operating conditions the output current is regulated via the IFB pin voltage (nominal value of 500 mV). This feedback is compared to an internal high precision bandgap voltage reference. An on-board dV/dt filter has also been used to ignore erroneous transitioning.

Once the supply to the IC reaches  $V_{CCUV+}$ , the LO output is held high and the HO output low for a predetermined period of time. This initiates charging of the bootstrap capacitor, establishing the  $V_{BS}$  floating supply for the high-side output. The IC then begins toggling HO and LO outputs as needed to regulate the current.

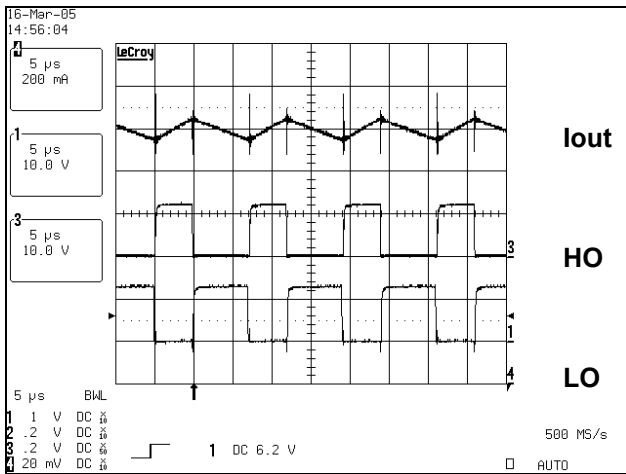

Fig.1 IRS254(01,11) Control Signals, Iavg=1.2 A

As long as  $V_{IFB}$  is below  $V_{IFBTH}$ , HO is on, modulated by the watchdog timer described below, which maintains charge for the floating high side on the bootstrap capacitor. The load is receiving current from  $V_{BUS}$ , which simultaneously stores energy in the inductor, as  $V_{IFB}$  increases, unless the load is open circuit. Once  $V_{IFB}$  crosses  $V_{IFBTH}$ , the control loop switches HO off after the delay  $t_{HO,OFF}$ . When HO switches off, LO will turn on after the deadtime (DT), the inductor then releases its stored energy into the load and  $V_{IFB}$  starts decreasing. When  $V_{IFB}$  drops below  $V_{IFBTH}$  again, the control loop switches HO on after the delay  $t_{HO,ON}$  and LO off after the delay  $t_{HO,ON} + DT$ . The switching continues to regulate the current at an average value

determined as follows. When the inductance value is large enough to maintain a low ripple on  $I_{FB}$ ,  $I_{out,avg}$  can be calculated:

$$I_{out(avg)} = V_{IFBTH} / RCS$$

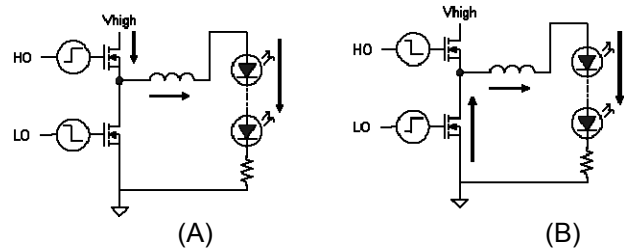

Fig.2 (A) Storing Energy in Inductor  
(B) Releasing Inductor Stored Energy

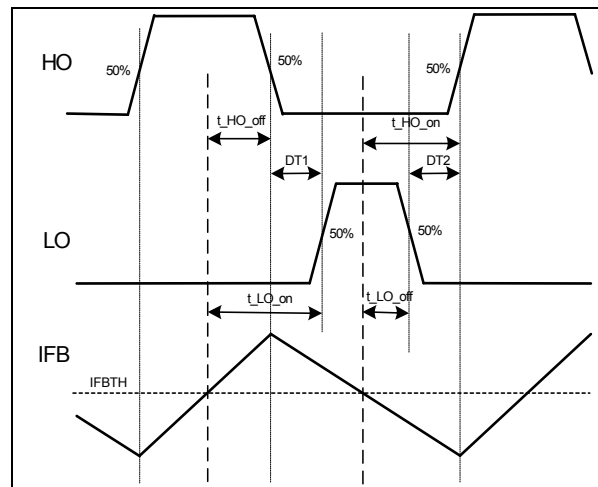

Fig.3 IRS254(0,1) Time Delayed Hysterisis

The control method is hysteretic with a free running frequency, which enables average current regulation in contrast to a fixed frequency scheme providing peak current regulation only. This reduces the part count since there is no need for frequency setting components and also provides an inherently stable system, which acts as a dynamic current source.

A deadtime of approximately 140 ns between the two gate drive signals is incorporated to prevent shoot-through. The deadtime has been adjusted to maintain precise current regulation, while still preventing shoot-through.

### Watchdog Timer

During an open circuit condition, without the watchdog timer, the HO output would remain high at all times and the charge stored in the bootstrap capacitor  $C_{BOOT}$  would gradually discharge the floating power supply for the high-side driver, which would then be unable to fully switch on the upper MOSFET causing high losses. To maintain sufficient charge on the bootstrap capacitor, a watchdog timer has been implemented. In the condition where  $V_{IFB}$  remains below  $V_{IFBTH}$ , the HO output is driven low after 20  $\mu$ s and the LO output forced high. This toggling of the outputs will last for approximately 1  $\mu$ s to maintain and replenish sufficient charge on  $C_{BOOT}$ .

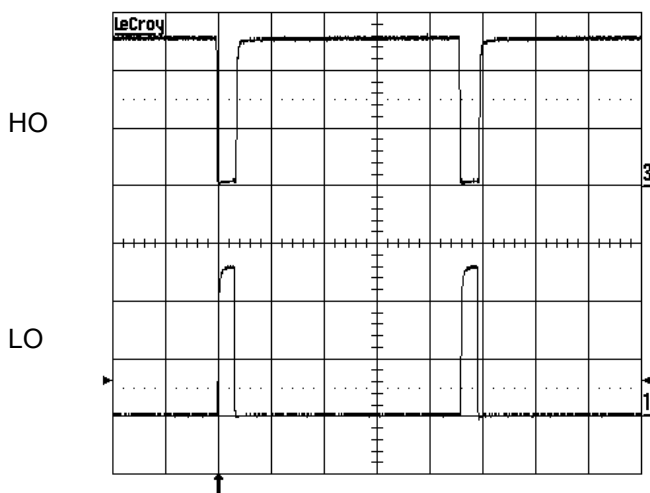

Fig.4 Illustration of Watchdog Timer

### Bootstrap Capacitor and Diode

The bootstrap capacitor value needs to be selected so that it maintains sufficient charge for at least the approximately 20  $\mu$ s interval until the watchdog timer allows the capacitor to recharge. If the capacitor value is too small, it will discharge in less than 20  $\mu$ s. The typical bootstrap capacitor is approximately 100 nF.

The bootstrap diode must be a fast recovery or ultrafast recovery component to maintain good efficiency. Since the cathode of the bootstrap diode will be switching between zero and to the high voltage bus, the reverse recovery time of this diode is critical. For additional information concerning the bootstrap components, refer to the Design Tip (DT 98-2), "Bootstrap Component Selection For Control ICs" at [www.irf.com](http://www.irf.com) under Design Support

### Disable (ENN) Pin

The disable pin can be used for PWM dimming and open-circuit protection. When the ENN pin is held low, the chip remains in a fully functional state with no alterations to the operating environment. To disable the control feedback and regulation, a voltage greater than  $V_{ENTH}$  (approximately 2.5 V) needs to be applied to the ENN pin. With the chip in a disabled state, HO output will remain low, whereas the LO output will remain high to prevent  $V_S$  from floating, in addition to maintaining charge on the bootstrap capacitor. The threshold for disabling the IRS254(01,11) has been set to 2.5 V to enhance noise immunity. This 2.5 V threshold also provides compatibility for a drive signal from a microcontroller.

### Dimming Mode

To achieve dimming, a signal with constant frequency and adjustable duty cycle can be fed into the ENN pin. There is a direct linear relationship between the average load current and duty cycle. If the ratio is 50%, 50% of the maximum set light output will be realized. Likewise if the ratio is 30%, 70% of the maximum set light output will be realized. A sufficiently high frequency of the dimming signal must be chosen to avoid noticeable flashing or "strobe light" effect. A signal above 120Hz up to 5kHz is sufficient.

The ENN pin logic is inverted to provide enable low so that the default state is with the IC running.

The minimum amount of dimming achievable (light output approaches 0%) will be determined by the "on" time of the HO output, when in a fully functional regulating state. To maintain reliable dimming, it is recommended to keep the "off" time of the enable signal at least 10 times that of the HO "on" time. For example, if the application is running at 75 kHz with an input voltage of 100 V and an output voltage of 20 V, the HO "on" time will be approximately 2.7  $\mu$ s according to standard buck topology theory. This will set the minimum "off" time of the enable signal to 27  $\mu$ s.

$$Duty\ Cycle = \frac{V_{out}}{V_{in}} * 100 = \frac{20V}{100V} * 100 = 20\%$$

$$HO_{on\ time} = 20\% * \frac{1}{75kHz} \approx 2.7\mu s$$

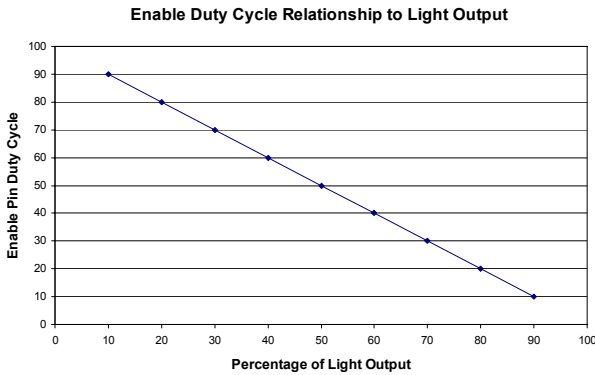

Fig.5 Light Output vs Enable Pin Duty Cycle

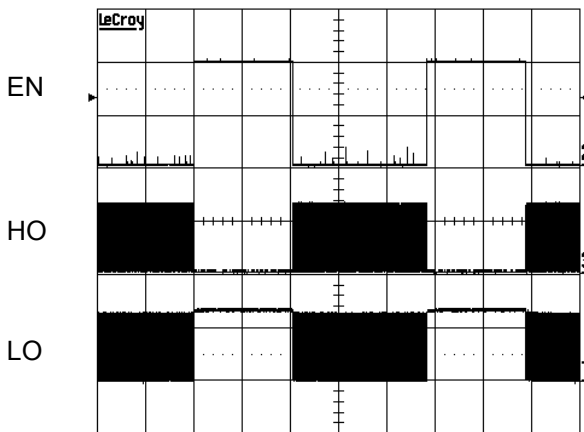

Fig.6 IRS254(01,11) Dimming Signals

**Open Circuit Protection Mode**

There are several methods of providing over voltage protection at the output if needed. The following very simple method uses a voltage divider, capacitor, and zener diode, the output voltage can be clamped at any desired value. In open-circuit condition without any output clamp, the positive output terminal may reach a high DC voltage. Switching will still occur between the HO and LO outputs, whether due to the output voltage clamp or the watchdog timer. Transients and switching will be observed at the positive output terminal as seen in Fig. 8. The difference in signal shape, between the output voltage and the  $I_{FB}$ , is due to the capacitor used

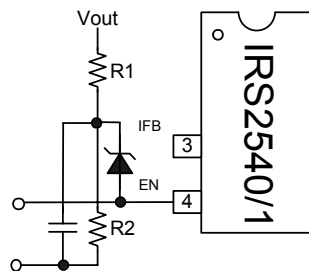

Fig.7 Open Circuit Protection Scheme

to form the voltage clamp. The repetition of the spikes can be reduced by simply increasing the capacitor size.

The two resistors form a voltage divider for the output, which is then fed into the cathode of the zener diode. The diode will only conduct, flooding the enable pin, when its nominal voltage is exceeded. The chip will enter a disabled state once the divider network produces a voltage at least 2.5 V greater than the zener rating. The capacitor serves only to filter and slow the transients/switching at the positive output terminal. The clamped output voltage can be determined by the following analysis. The choice of capacitor is at the designer's discretion.

This scheme will not be adequate in all applications. An improved method is described in IRPLLED1 Rev D reference design documentation.

$$V_{out} = \frac{(2.5V + DZ)(R_1 + R_2)}{R_2}$$

$DZ$  = Zener Diode Nominal Rated Voltage

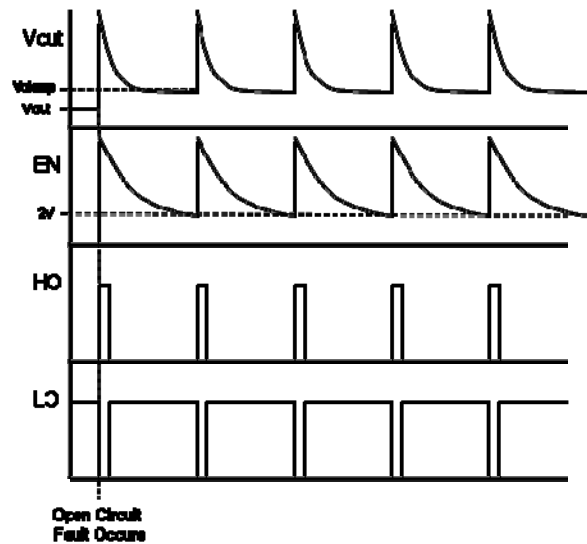

Fig.8 Open Circuit Fault Signals, with Clamp

**Under-voltage Lock-out Mode**

The under-voltage lock-out mode (UVLO) is defined as the state IRS254(01,11) is in when  $V_{CC}$  is below the turn-on threshold of the IC. During startup conditions, if the IC supply remains below  $V_{CCUV+}$ , the IRS254(01,11) will enter the UVLO mode. This state is very similar to when the IC has been disabled via control signals, except that LO is also held low. When the supply is increased to  $V_{CCUV+}$ , the IC enters

the normal operation mode. If already in normal operation, the IC does not enter UVLO unless the supply voltage falls below  $V_{CCUV}$ .

**Inductance Selection**

To maintain tight hysteretic current regulation the inductor and output capacitor  $C_{OUT}$  (in parallel with the LEDs) need to be large enough to maintain the supply to the load during  $t_{HO,ON}$  and avoid significant undershooting of the load current, which in turn causes the average current to fall below the desired value.

First, consider the effect of the inductor when there is no output capacitor to clearly demonstrate the impact of the inductor. In this case, the load current is identical to the inductor current. Fig. 9 shows how the inductor value impacts the frequency over a range of input voltages. As can be seen, the input voltage has a great impact on the frequency and the inductor value has the greatest impact at reducing the frequency for smaller input voltages.

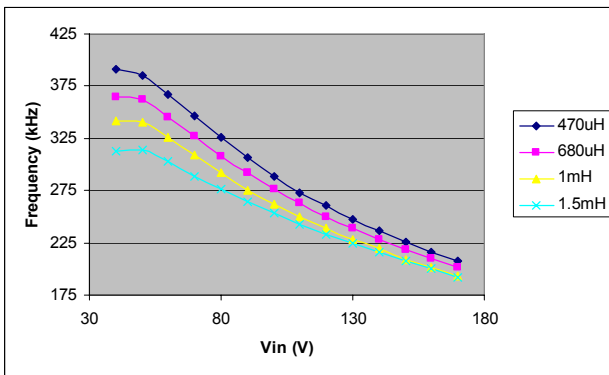
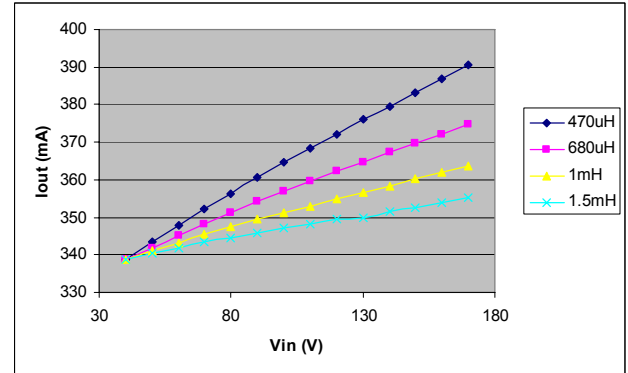

**Fig.9 Frequency Response for Chosen Inductances**  
 $I_{out} = 350 \text{ mA}, V_{out} = 16.8 \text{ V}$

Fig. 10 shows how the variation in load current increases over a span of input voltages, as the inductance is decreased. Fig. 11 shows the variation of frequency over different output voltages and different inductance values. Finally Fig. 12 shows how the load current variation increases with lower inductance over a range of output voltages.

The output capacitor can be used simultaneously to achieve the target frequency and current control accuracy. Fig. 11 shows how the capacitance reduces the frequency over a range of input voltage. A small capacitance of  $4.7 \mu\text{F}$  has a large effect on reducing the frequency. Fig. 12 shows how the current regulation is also improved with the output capacitance. There is a point at which continuing to add capacitance no longer

has a significant effect on the operating frequency or current regulation, as can be seen in Figs. 13 and 14.



**Fig.10 Current Regulation for Chosen Inductances**  
 $I_{out} = 350 \text{ mA}, V_{out} = 16.8 \text{ V}$

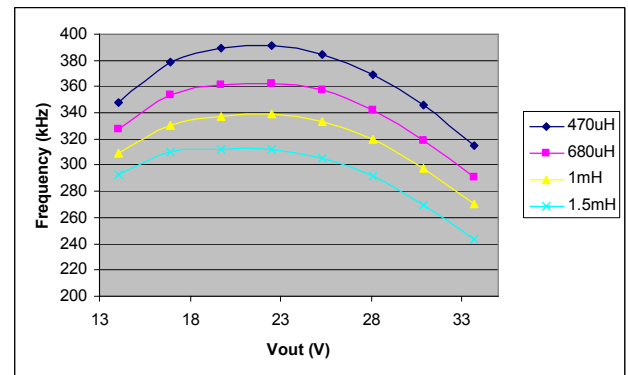

**Fig.11 Frequency Response for Chosen Inductances**  
 $I_{out} = 350 \text{ mA}, V_{in} = 50 \text{ V}$

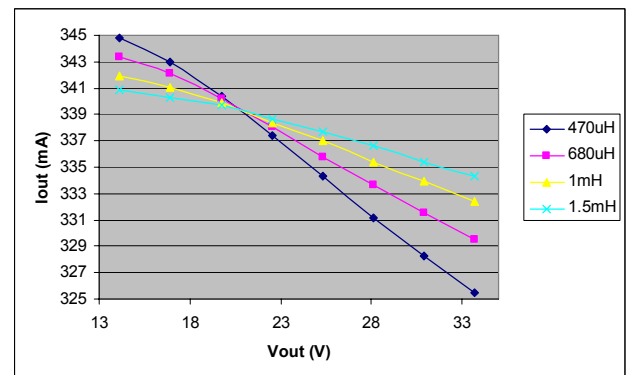

**Fig.12 Current Regulation for Chosen Inductances**  
 $I_{out} = 350 \text{ mA}, V_{in} = 50 \text{ V}$

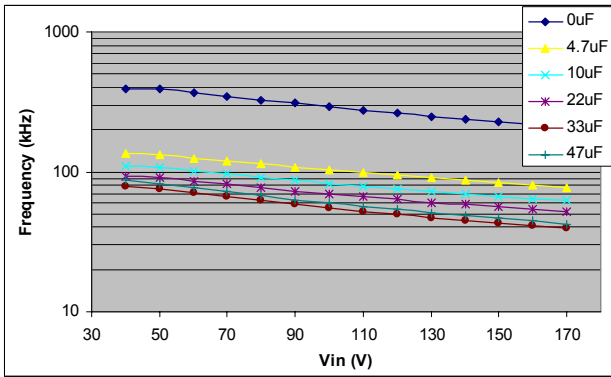

Fig. 13 I<sub>out</sub> = 350 mA, V<sub>out</sub> = 16.8 V, L = 470 μH

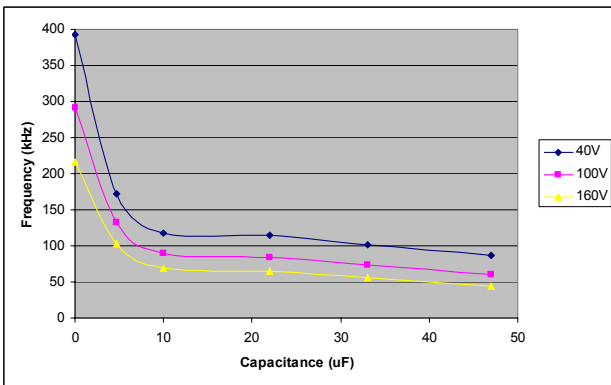

Fig. 14 I<sub>out</sub> = 350 mA, V<sub>out</sub> = 16.8 V, L = 470 μH

The addition of the C<sub>OUT</sub> increases the amount of energy that can be stored in the output stage, which also means it can supply current for an increased period of time. Therefore by slowing down the di/dt transients in the load, the frequency is effectively decreased.

With the C<sub>OUT</sub> capacitor, the inductor current is no longer identical to that seen in the load. The inductor current will still have a perfectly triangular shape, where as the load will see the same basic trend in the current, but all sharp corners will be rounded with all peaks significantly reduced, as can be seen in Fig. 15

### VCC Supply

Since the IRS254(01,11) is rated for 200 V (or 600 V), V<sub>BUS</sub> can reach values of this magnitude. If a supply resistor to V<sub>BUS</sub> is used, it can experience high power losses. For higher voltage applications if the output voltage is above V<sub>CCUV+</sub> plus one diode drop an alternate V<sub>CC</sub> supply scheme utilizing the micro-power start-up and a resistor feed-back from the output can be implemented, as seen in Fig. 16.

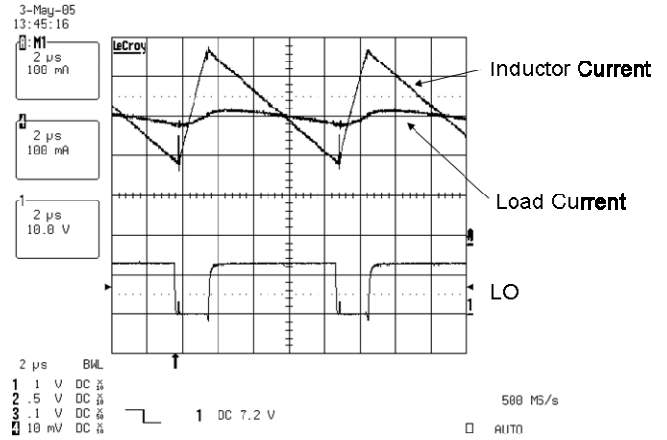

Fig. 15 I<sub>out</sub> = 350 mA, V<sub>in</sub> = 100 V, V<sub>out</sub> = 16.85 V, L = 470 μH, C<sub>out</sub> = 33 μF

The resistance between V<sub>BUS</sub> and V<sub>CC</sub> supply should be large enough to minimize the current sourced directly from the input voltage line; value should be on the order of hundreds of kΩ. Through the supply resistor, a current will flow to charge the V<sub>CC</sub> capacitor. Once the capacitor is charged up to the V<sub>CCUV+</sub> threshold, the IRS254(01,11) enters the micro start-up regime and begins to operate, activating the LO and HO outputs. After the first few cycles of switching, the resistor connected between the output and V<sub>CC</sub> will take over and source all necessary current for the IC. The resistor connecting the output to the supply should be carefully designed according to its power rating.

$$RS2 = \frac{V_{out} - 15.6V}{10mA}$$

$$P_{RS2} = (10mA)^2 RS2 \leq \frac{P_{RS2\_Rated}}{2}$$

$$I_{cc} \approx 10mA$$

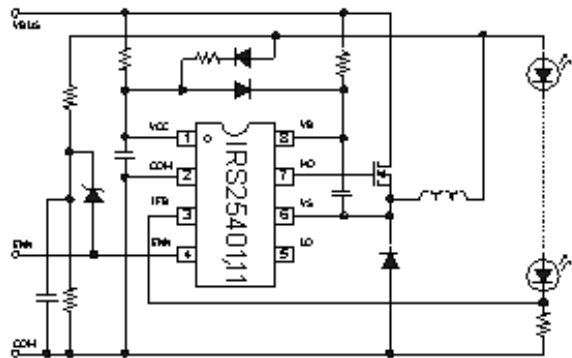
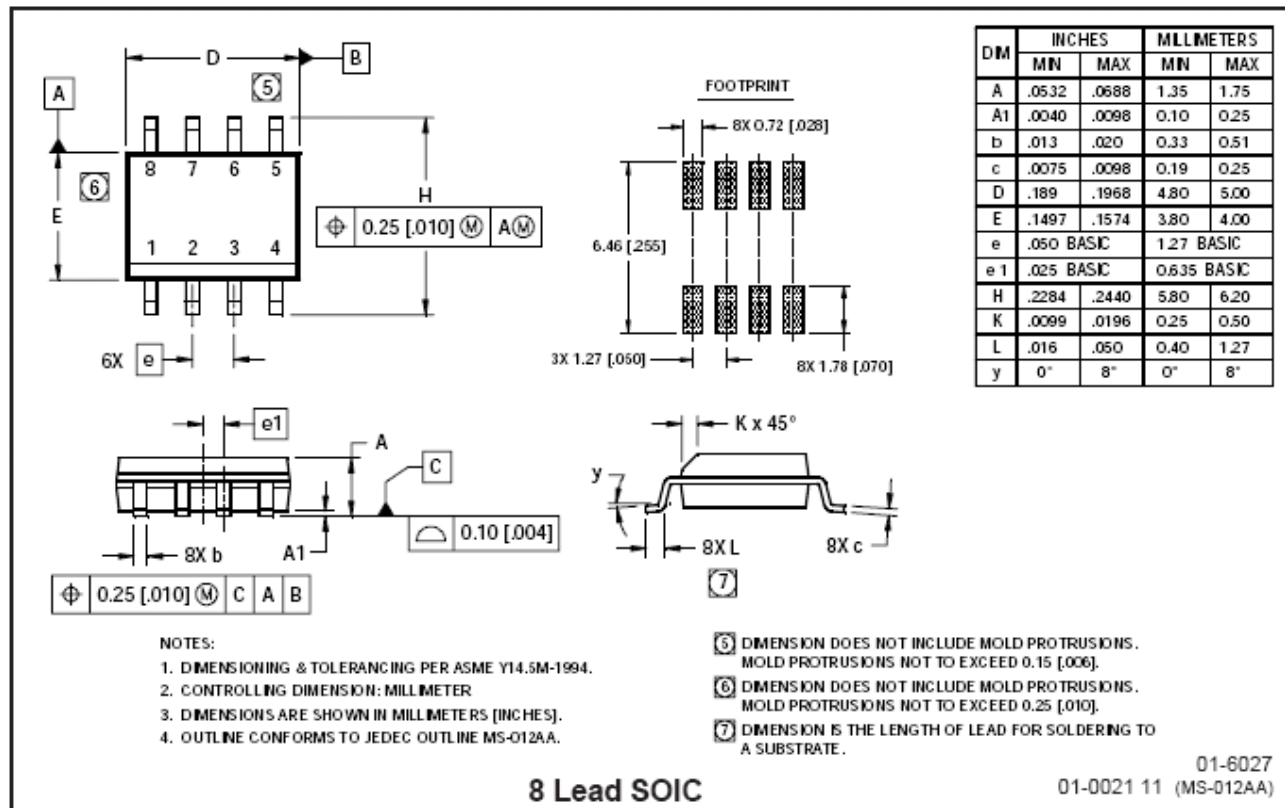
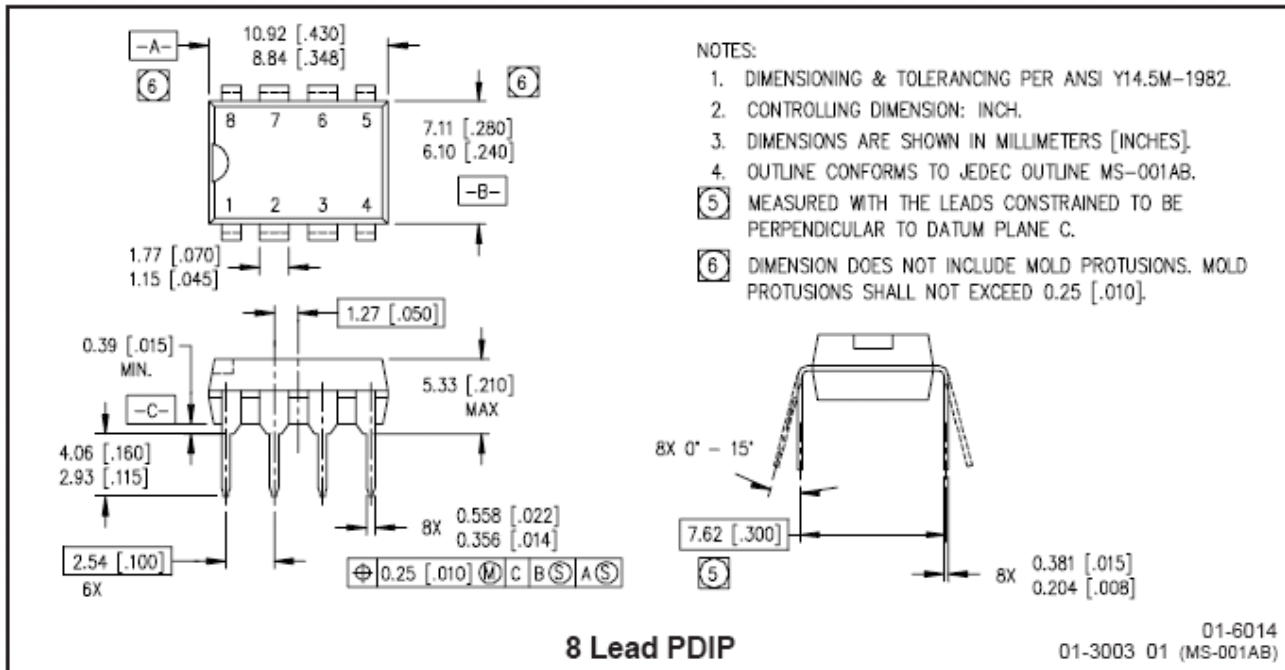

Fig. 16 Alternate Supply Diagram



**Package Details**



**Tape and Reel Details**

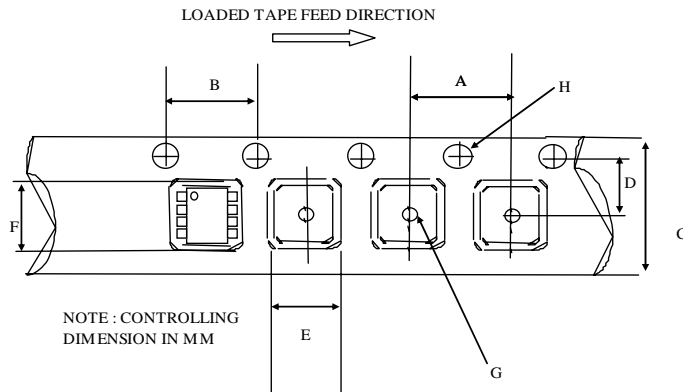

CARRIER TAPE DIMENSION FOR 8SOICN

Code	Metric		Imperial	
	Min	Max	Min	Max
A	7.90	8.10	0.311	0.318
B	3.90	4.10	0.153	0.161
C	11.70	12.30	0.46	0.484
D	5.45	5.55	0.214	0.218
E	6.30	6.50	0.248	0.255
F	5.10	5.30	0.200	0.208
G	1.50	n/a	0.059	n/a
H	1.50	1.60	0.059	0.062

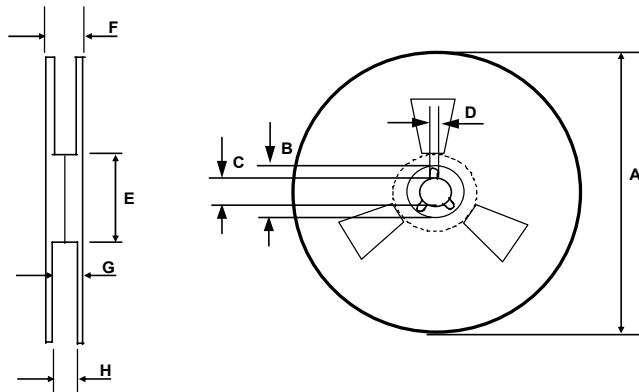

REEL DIMENSIONS FOR 8SOICN

Code	Metric		Imperial	
	Min	Max	Min	Max
A	329.60	330.25	12.976	13.001
B	20.95	21.45	0.824	0.844
C	12.80	13.20	0.503	0.519
D	1.95	2.45	0.767	0.096
E	98.00	102.00	3.858	4.015
F	n/a	18.40	n/a	0.724
G	14.50	17.10	0.570	0.673
H	12.40	14.40	0.488	0.566

**Part Marking Information**

**SOIC**

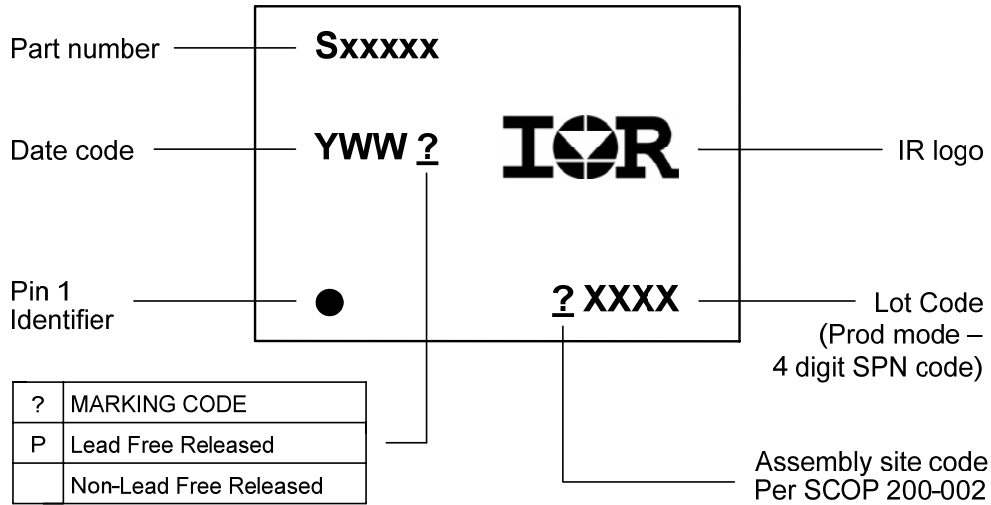

**PDIP**

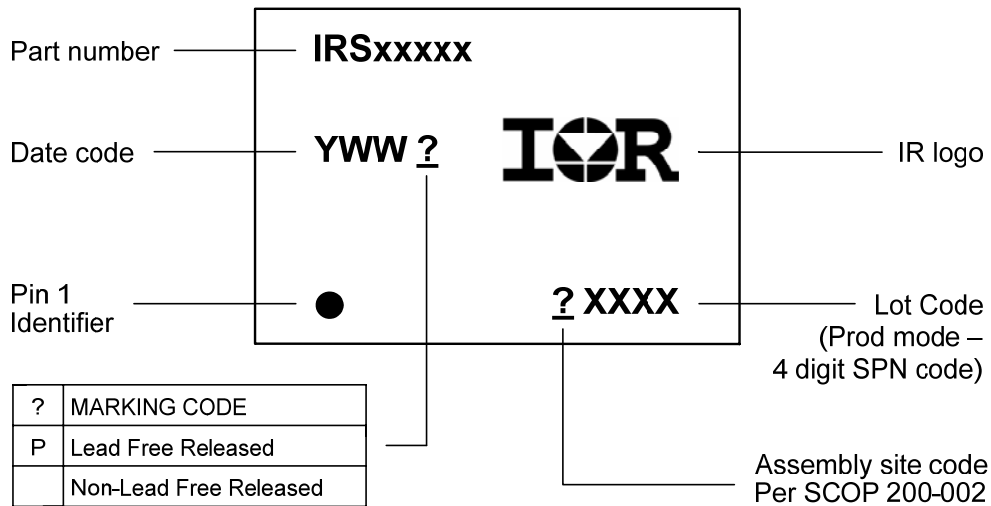

**Ordering Information**

Base Part Number	Package Type	Standard Pack		Complete Part Number
		Form	Quantity	
IRS25401	PDIP8	Tube/Bulk	50	IRS25401PBF
	SOIC8	Tube/Bulk	95	IRS25401SPBF
		Tape and Reel	2500	IRS25401STRPBF
IRS25411	PDIP8	Tube/Bulk	50	IRS25411PBF
	SOIC8	Tube/Bulk	95	IRS25411SPBF
		Tape and Reel	2500	IRS25411STRPBF

The information provided in this document is believed to be accurate and reliable. However, International Rectifier assumes no responsibility for the consequences of the use of this information. International Rectifier assumes no responsibility for any infringement of patents or of other rights of third parties which may result from the use of this information. No license is granted by implication or otherwise under any patent or patent rights of International Rectifier. The specifications mentioned in this document are subject to change without notice. This document supersedes and replaces all information previously supplied.

For technical support, please contact IR's Technical Assistance Center

<http://www.irf.com/technical-info/>

**WORLD HEADQUARTERS:**  
 233 Kansas St., El Segundo, California 90245  
 Tel: (310) 252-7105