

NOTES

MATERIAL - DIECAST ALUMINUM ALLOY
 - FOUR M14 CAPTIVE SCREWS

POWDER COATED -
 Col. RAL 7032

GASKET - POLYURATHANE
 -40°C TO +80°C
 TEMP. RANGE

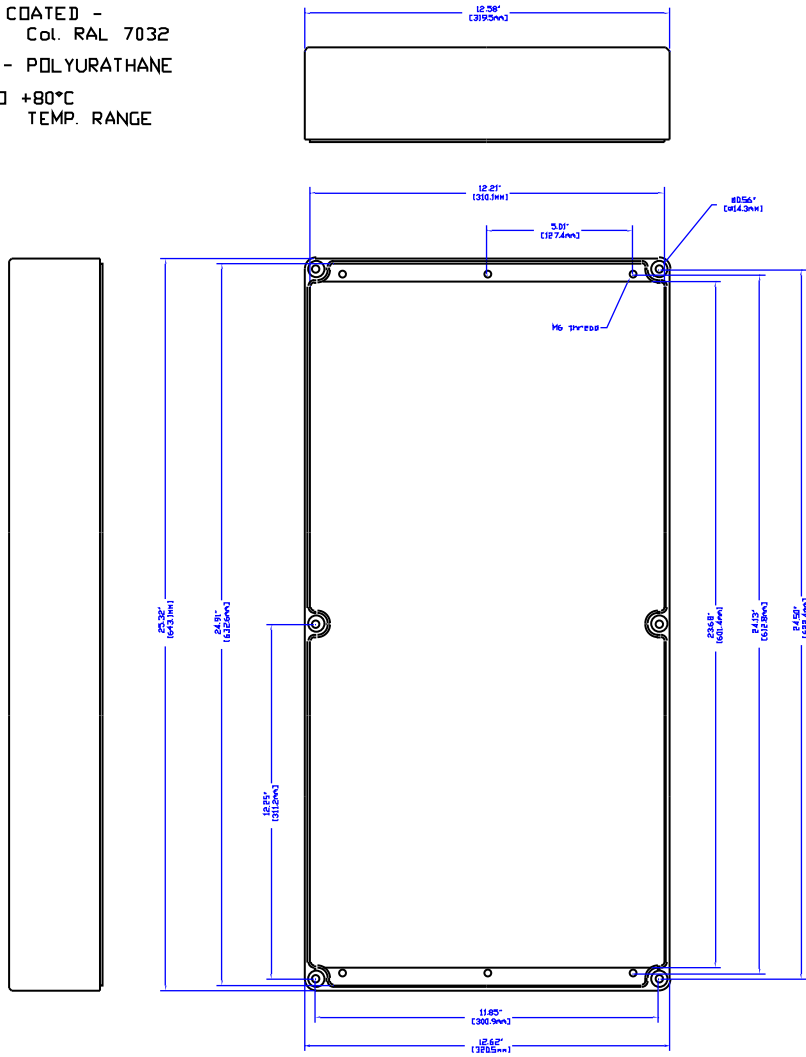

VIEW OF BOX (LID REMOVED)

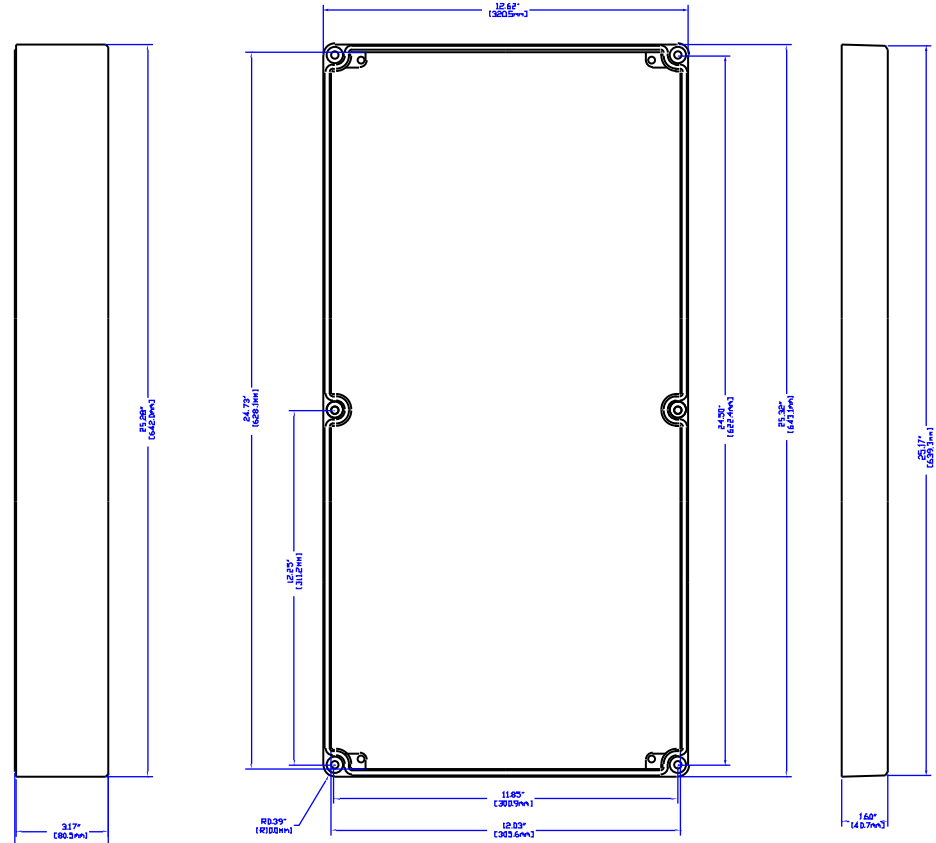

VIEW OF LID (INSIDE)



HAMMOND MANUFACTURING

R100-324-000

CANADA - PH (519) 886 7170 - FAX (519) 886 8311
 U.S.A. - PH (716) 631 5700 - FAX (716) 631 1156