

MAX17632

4.5V to 36V, 2A, High-Efficiency, Synchronous Step-Down DC-DC Converter

General Description

The MAX17632 family of parts (MAX17632A, MAX17632B and MAX17632C) is a high-efficiency, high-voltage, synchronous step-down DC-DC converter with integrated MOSFETs operating over an input-voltage range of 4.5V to 36V. It can deliver up to 2A current. The MAX17632A and MAX17632B are fixed 3.3V and fixed 5V output parts, respectively. The MAX17632C is an adjustable output voltage (0.9V to 90% of V_{IN}) part. Built-in compensation across the output-voltage range eliminates the need for external compensation components.

The MAX17632 features peak-current-mode control architecture. The device can be operated in the forced pulse-width modulation (PWM), or pulse-frequency modulation (PFM), or discontinuous-conduction mode (DCM) to enable high efficiency under full-load and light-load conditions. The MAX17632 offers a low minimum on time that allows high switching frequencies and a smaller solution size.

The feedback-voltage regulation accuracy over -40°C to $+125^{\circ}\text{C}$ for the MAX17632A/MAX17632B/MAX17632C is $\pm 1.2\%$. The device is available in a 16-pin (3mm x 3mm) TQFN package. Simulation models are available.

Applications

- Industrial Control Power Supplies
- General-Purpose Point-of-Load
- Distributed Supply Regulation
- Base Station Power Supplies
- Wall Transformer Regulation
- High Voltage Single-Board Systems

Benefits and Features

- Reduces External Components and Total Cost
 - No Schottky - Synchronous Operation
 - Internal Compensation Components
 - All-Ceramic Capacitors, Compact Layout
- Reduces Number of DC-DC Regulators to Stock
 - Wide 4.5V to 36V Input
 - Adjustable Output Range from 0.9V to 90% of V_{IN}
 - Delivers Up to 2A Over Temperature Range
 - 400kHz to 2.2MHz Adjustable Frequency with External Clock Synchronization
 - Available in a 16-Pin, 3mm x 3mm TQFN Package
- Reduces Power Dissipation
 - Peak Efficiency > 90%
 - PFM and DCM Modes Enable Enhanced Light-Load Efficiency
 - Auxiliary Bootstrap Supply (EXTVCC) for Improved Efficiency
 - 2.8 μA Shutdown Current
- Operates Reliably in Adverse Industrial Environments
 - Hiccup-Mode Overload Protection
 - Adjustable and Monotonic Startup with Prebiased Output Voltage
 - Built-in Output-Voltage Monitoring with $\overline{\text{RESET}}$
 - Programmable EN/UVLO Threshold
 - Overtemperature Protection
 - High Industrial -40°C to $+125^{\circ}\text{C}$ Ambient Operating Temperature Range / -40°C to $+150^{\circ}\text{C}$ Junction Temperature Range

[Ordering Information](#) appears at end of data sheet.

Typical Application Circuit

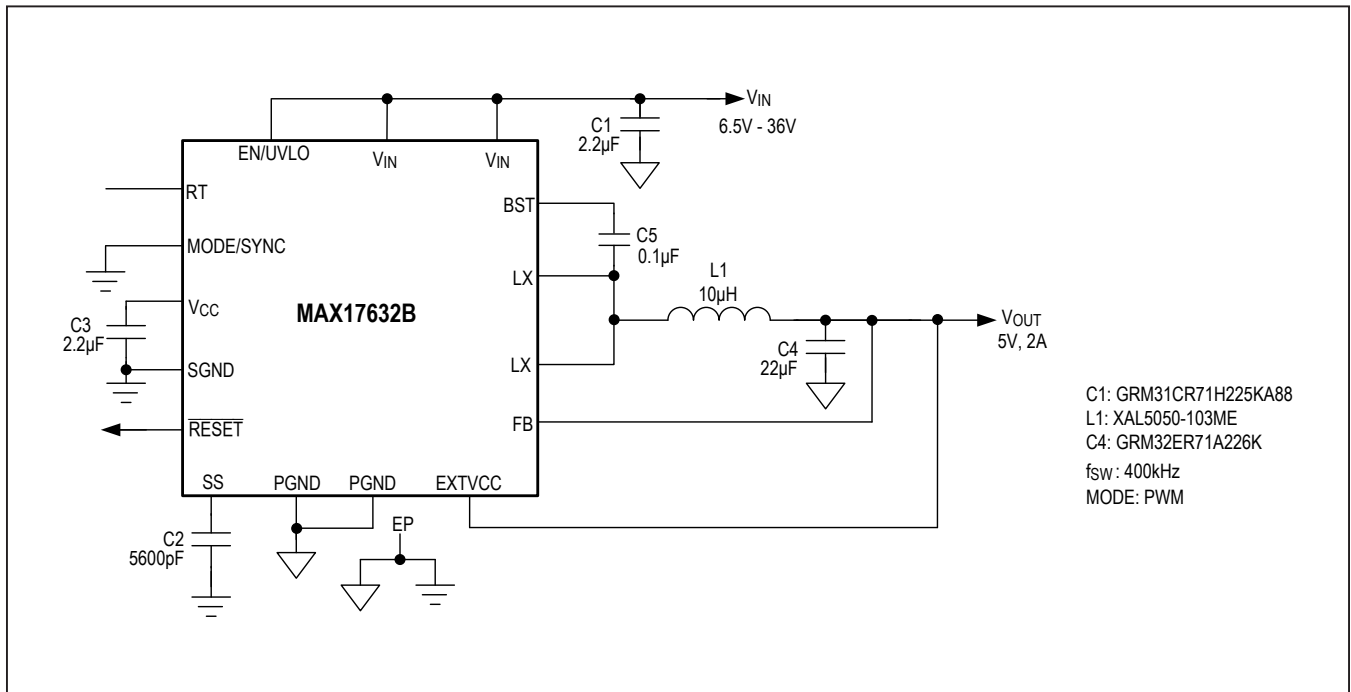

Absolute Maximum Ratings

V_{IN} to PGND	-0.3V to +40V	PGND to SGND.....	-0.3V to +0.3V
EN/UVLO to SGND	-0.3V to V_{IN} + 0.3V	LX total RMS current.....	$\pm 3.5A$
LX to PGND.....	-0.3V to V_{IN} + 0.3V	Output Short-Circuit Duration	Continuous
EXTVCC to SGND	-5.5V to +6.5V	Continuous Power Dissipation (Multilayer Board)	
BST to PGND	-0.3V to +46.5V	($T_A = +70^\circ C$, derate 20.8mW/ $^\circ C$ above $+70^\circ C$.).....	1666.7mW
BST to LX.....	-0.3V to +6.5V	Operating Temperature Range (Note 1).....	-40°C to 125°C
BST to V_{CC}	-0.3V to +40V	Junction Temperature.....	+150°C
RESET, SS, MODE/SYNC, V_{CC} , RT to SGND ...	-0.3V to +6.5V	Storage Temperature Range	-65°C to +150°C
FB to SGND (MAX17632A & MAX17632B).....	-5.5V to 6.5V	Lead Temperature (soldering, 10s)	+300°C
FB to SGND (MAX17632C)	-0.3V to 6.5V	Soldering Temperature (reflow).....	+260°C

Stresses beyond those listed under "Absolute Maximum Ratings" may cause permanent damage to the device. These are stress ratings only, and functional operation of the device at these or any other conditions beyond those indicated in the operational sections of the specifications is not implied. Exposure to absolute maximum rating conditions for extended periods may affect device reliability.

Package Information

PACKAGE TYPE: 16-PIN TQFN	
Package Code	T1633+5C
Outline Number	21-0136
Land Pattern Number	90-0032
THERMAL RESISTANCE, FOUR-LAYER BOARD (Note 2)	
Junction to Ambient (θ_{JA})	38°C/W
Junction to Case (θ_{JC})	10°C/W

For the latest package outline information and land patterns (footprints), go to www.maximintegrated.com/packages. Note that a "+", "#", or "-" in the package code indicates RoHS status only. Package drawings may show a different suffix character, but the drawing pertains to the package regardless of RoHS status.

- Note 1:** Junction temperature greater than +125°C degrades operating lifetimes.
- Note 2:** Package thermal resistances were obtained using the MAX17632 Evaluation Kit.

Electrical Characteristics

($V_{IN} = V_{EN/UVLO} = 24V$, $R_{RT} =$ unconnected ($f_{SW} = 400$ kHz), $C_{VCC} = 2.2\mu F$, $V_{MODE/SYNC} = V_{EXTVCC} = V_{SGND} = V_{PGND} = 0V$, $V_{FB} = 3.67V$ (MAX17632A), $V_{FB} = 5.5V$ (MAX17632B), $V_{FB} = 1V$ (MAX17632C), $LX = SS = \overline{RESET} =$ Open, V_{BST} to $V_{LX} = 5V$, $T_A = -40^\circ C$ to $125^\circ C$, unless otherwise noted. Typical values are at $T_A = +25^\circ C$. All voltages are referenced to SGND, unless otherwise noted.) (Note 3)

PARAMETER	SYMBOL	CONDITIONS	MIN	TYP	MAX	UNITS
INPUT SUPPLY (V_{IN})						
Input-Voltage Range	V_{IN}		4.5		36	V
Input-Shutdown Current	I_{IN-SH}	$V_{EN/UVLO} = 0V$ (Shutdown mode)		2.8	4.5	μA
Input-Quiescent Current	I_{Q_PFM}	MODE/SYNC = Open, $V_{EXTVCC} = 5V$		50		μA
		MODE/SYNC = Open, $R_{RT} = 50.8k\Omega$, $V_{EXTVCC} = 5V$		60		
	I_{Q_DCM}	DCM Mode, $V_{LX} = 0.1V$		1.2	1.8	mA
	I_{Q_PWM}	Normal Switching Mode, $f_{SW} = 400kHz$, $V_{FB} = 3V$ (MAX17632A), $V_{FB} = 4.4V$ (MAX17632B), $V_{FB} = 0.8V$ (MAX17632C)		5		

Electrical Characteristics (continued)

($V_{IN} = V_{EN/UVLO} = 24V$, $R_{RT} =$ unconnected ($f_{SW} = 400$ kHz), $C_{VCC} = 2.2\mu F$, $V_{MODE/SYNC} = V_{EXTVCC} = V_{SGND} = V_{PGND} = 0V$, $V_{FB} = 3.67V$ (MAX17632A), $V_{FB} = 5.5V$ (MAX17632B), $V_{FB} = 1V$ (MAX17632C), $LX = SS = RESET =$ Open, V_{BST} to $V_{LX} = 5V$, $T_A = -40^\circ C$ to $125^\circ C$, unless otherwise noted. Typical values are at $T_A = +25^\circ C$. All voltages are referenced to SGND, unless otherwise noted.) (Note 3)

PARAMETER	SYMBOL	CONDITIONS	MIN	TYP	MAX	UNITS
ENABLE/UVLO (EN/UVLO)						
EN/UVLO Threshold	V_{ENR}	$V_{EN/UVLO}$ rising	1.19	1.215	1.26	V
	V_{ENF}	$V_{EN/UVLO}$ falling	1.068	1.09	1.131	
EN Input-Leakage Current	I_{EN}	$V_{EN/UVLO} = 0V$, $T_A = +25^\circ C$	-50	0	+50	nA
V_{CC} (LDO)						
V _{CC} Output-Voltage Range	V_{CC}	$1mA \leq I_{VCC} \leq 15mA$	4.75	5	5.25	V
		$6V \leq V_{IN} \leq 36V$, $I_{VCC} = 1mA$	4.75	5	5.25	
V _{CC} Current Limit	$I_{VCC-MAX}$	$V_{CC} = 4.5V$, $V_{IN} = 7.5V$	25	50		mA
V _{CC} Dropout	V_{CC-DO}	$V_{IN} = 4.5V$, $I_{VCC} = 10mA$			0.3	V
V _{CC} UVLO	V_{CC_UVR}	V _{CC} rising	4.05	4.2	4.3	V
	V_{CC_UVF}	V _{CC} falling	3.65	3.8	3.9	
EXTVCC						
EXTVCC Switchover Threshold		V_{EXTVCC} rising	4.56	4.7	4.84	V
		V_{EXTVCC} falling	4.3	4.45	4.6	
POWER MOSFETS						
High-Side nMOS On-Resistance	R_{DS-ONH}	$I_{LX} = 0.3A$, sourcing		125	250	mΩ
Low-Side nMOS On-Resistance	R_{DS-ONL}	$I_{LX} = 0.3A$, sinking		80	160	mΩ
LX Leakage Current	I_{LX_LKG}	$V_{LX} = (V_{PGND} + 1V)$ to $(V_{IN} - 1V)$, $T_A = +25^\circ C$	-2		+3	μA
SOFT-START (SS)						
Charging Current	I_{SS}	$V_{SS} = 0.5V$	4.7	5	5.3	μA
FEEDBACK (FB)						
FB Regulation Voltage	V_{FB-REG}	MODE/SYNC = SGND or MODE/SYNC = V_{CC} , for MAX17632A	3.26	3.3	3.34	V
		MODE/SYNC = SGND or MODE/SYNC = V_{CC} , for MAX17632B	4.94	5	5.06	
		MODE/SYNC = SGND or MODE/SYNC = V_{CC} , for MAX17632C	0.889	0.9	0.911	
		MODE/SYNC = Open, for MAX17632A	3.26	3.36	3.43	
		MODE/SYNC = Open, for MAX17632B	4.94	5.09	5.20	
		MODE/SYNC = Open, for MAX17632C	0.89	0.915	0.936	
FB Input-Bias Current	I_{FB}	For MAX17632A		21		μA
		For MAX17632B		17		
		$0 \leq V_{FB} \leq 1V$, $T_A = 25^\circ C$, For MAX17632C	-50		+50	nA

Electrical Characteristics (continued)

($V_{IN} = V_{EN}/UVLO = 24V$, $R_{RT} = \text{unconnected}$ ($f_{SW} = 400 \text{ kHz}$), $C_{VCC} = 2.2\mu F$, $V_{MODE/SYNC} = V_{EXTVCC} = V_{SGND} = V_{PGND} = 0V$, $V_{FB} = 3.67V$ (MAX17632A), $V_{FB} = 5.5V$ (MAX17632B), $V_{FB} = 1V$ (MAX17632C), $LX = SS = RESET = \text{Open}$, V_{BST} to $V_{LX} = 5V$, $T_A = -40^\circ C$ to $125^\circ C$, unless otherwise noted. Typical values are at $T_A = +25^\circ C$. All voltages are referenced to SGND, unless otherwise noted.) (Note 3)

PARAMETER	SYMBOL	CONDITIONS	MIN	TYP	MAX	UNITS
MODE/SYNC						
MODE Threshold	V_{M-DCM}	MODE/SYNC = V_{CC} (DCM mode)	$V_{CC} - 0.65$			V
	V_{M-PFM}	MODE/SYNC = Open (PFM mode)		$V_{CC}/2$		
	V_{M-PWM}	MODE/SYNC = SGND (PWM mode)			0.75	
SYNC Frequency-Capture Range	f_{SYNC}	f_{SW} set by R_{RT}	$1.1 \times f_{SW}$		$1.4 \times f_{SW}$	kHz
SYNC Pulse Width			50			ns
SYNC Threshold	V_{IH}		2.1			V
	V_{IL}				0.8	
CURRENT LIMIT						
Peak Current-Limit Threshold	$I_{PEAK-LIMIT}$		2.7	3.15	3.6	A
Runaway Peak Current-Limit Threshold	$I_{RUNAWAY-LIMIT}$		3	3.6	4.1	A
PFM Peak Current-Limit Threshold	I_{PFM}	MODE/SYNC = Open		0.8		A
Valley Current-Limit Threshold	$I_{VALLEY-LIMIT}$	MODE/SYNC = Open or MODE/SYNC = V_{CC}	-0.15	0	+0.15	A
		MODE/SYNC = SGND, $V_{FB} > 0.65$		-1.8		
RT						
Switching Frequency	f_{SW}	$R_{RT} = 50.8k\Omega$	380	400	420	kHz
		$R_{RT} = 40.2k\Omega$	475	500	525	
		$R_{RT} = 8.06k\Omega$	1950	2200	2450	
		$R_{RT} = \text{Open}$	370	400	430	
V_{FB} Undervoltage Trip Level to Cause Hiccup	$V_{FB-HICF}$	For MAX17632A	2.05	2.13	2.2	V
		For MAX17632B	3.11	3.22	3.33	
		For MAX17632C	0.56	0.58	0.6	
HICCUP Timeout		(Note 4)		32768		Cycles
Minimum On-Time	t_{ON-MIN}			52	80	ns
Minimum Off-Time	$t_{OFF-MIN}$		140		160	ns
LX Dead Time	LX_{DT}			5		ns

Electrical Characteristics (continued)

($V_{IN} = V_{EN}/UVLO = 24V$, $R_{RT} = \text{unconnected}$ ($f_{SW} = 400 \text{ kHz}$), $C_{VCC} = 2.2\mu F$, $V_{MODE}/SYNC = V_{EXTVCC} = V_{SGND} = V_{PGND} = 0V$, $V_{FB} = 3.67V$ (MAX17632A), $V_{FB} = 5.5V$ (MAX17632B), $V_{FB} = 1V$ (MAX17632C), $LX = SS = \overline{RESET} = \text{Open}$, V_{BST} to $V_{LX} = 5V$, $T_A = -40^\circ C$ to $125^\circ C$, unless otherwise noted. Typical values are at $T_A = +25^\circ C$. All voltages are referenced to $SGND$, unless otherwise noted.) (Note 3)

PARAMETER	SYMBOL	CONDITIONS	MIN	TYP	MAX	UNITS
\overline{RESET}						
\overline{RESET} Output-Level Low	V_{RESETL}	$I_{RESET} = 10mA$			400	mV
\overline{RESET} Output-Leakage Current	$I_{RESETLKG}$	$T_A = T_J = 25^\circ C$, $V_{\overline{RESET}} = 5.5V$	-100		100	nA
FB Threshold for \overline{RESET} Deassertion	V_{FB-OKR}	V_{FB} rising	93.8	95	97.8	%
FB Threshold for \overline{RESET} Assertion	V_{FB-OKF}	V_{FB} falling	90.5	92	94.6	%
\overline{RESET} Delay after FB Reaches 95% Regulation				1024		cycles
THERMAL SHUTDOWN (TEMP)						
Thermal-Shutdown Threshold		Temperature rising		165		$^\circ C$
Thermal-Shutdown Hysteresis				10		$^\circ C$

Note 3: Electrical specifications are production tested at $T_A = +25^\circ C$. Specifications over the entire operating temperature range are guaranteed by design and characterization.

Note 4: See the [Overcurrent Protection \(OCP\)/Hiccup Mode](#) section for more details

Typical Operating Characteristics

($V_{EN}/UV_{LO} = V_{IN} = 24V$, $V_{SGND} = V_{PGND} = 0V$, $C_{VCC} = 2.2\mu F$, $C_{BST} = 0.1\mu F$, $C_{SS} = 5600pF$, $T_A = -40^{\circ}C$ to $+125^{\circ}C$, unless otherwise noted. Typical values are at $T_A = +25^{\circ}C$. All voltages are referenced to SGND, unless otherwise noted.)

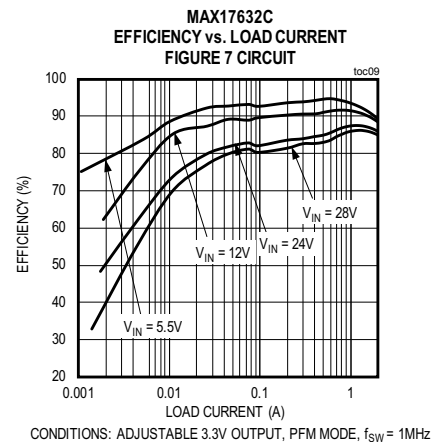
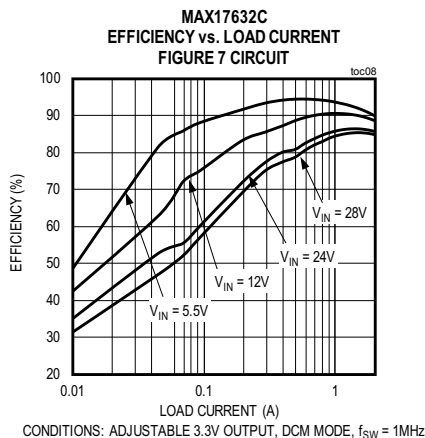
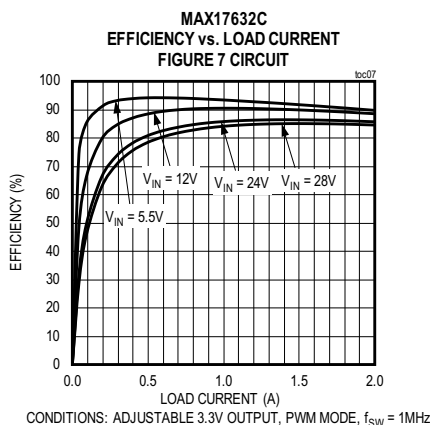
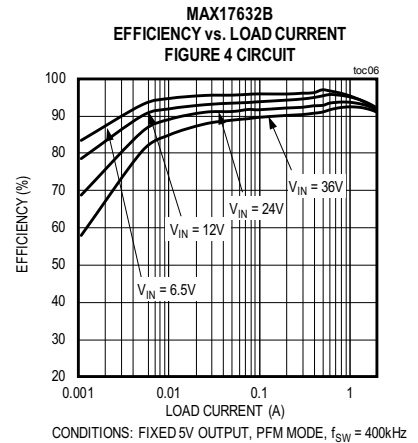
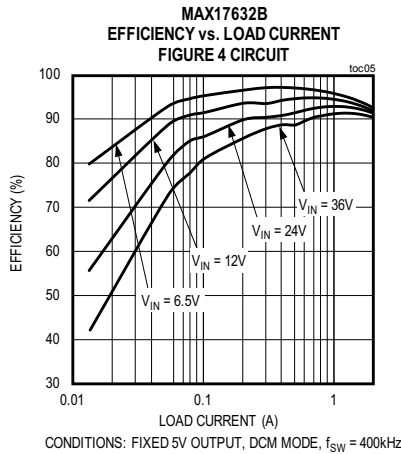
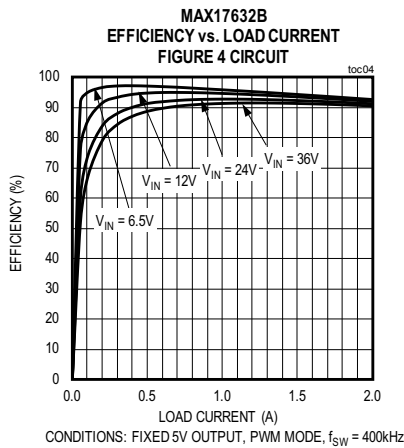
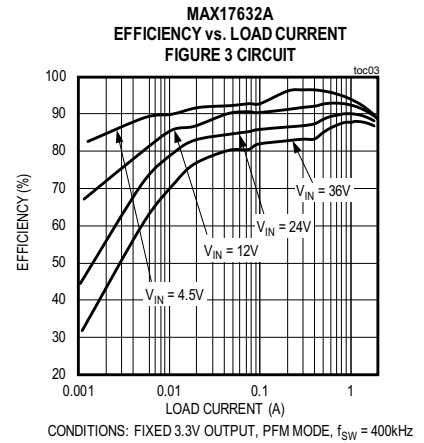
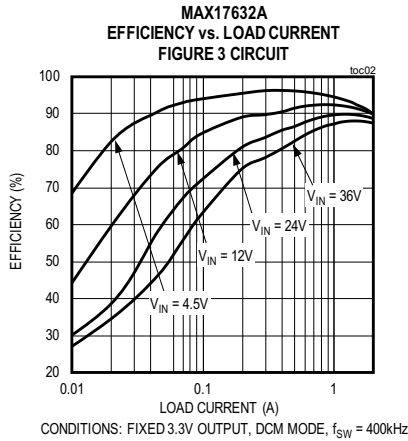
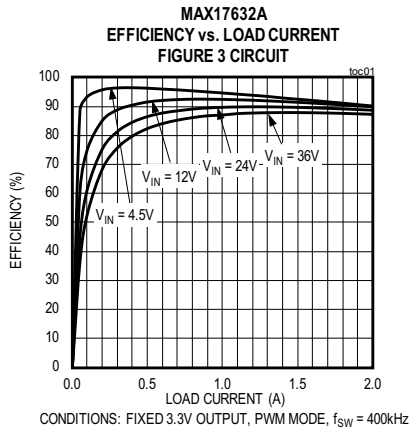

Typical Operating Characteristics (continued)

($V_{EN}/UVLO = V_{IN} = 24V$, $V_{SGND} = V_{PGND} = 0V$, $C_{VCC} = 2.2\mu F$, $C_{BST} = 0.1\mu F$, $C_{SS} = 5600pF$, $T_A = -40^{\circ}C$ to $+125^{\circ}C$, unless otherwise noted. Typical values are at $T_A = +25^{\circ}C$. All voltages are referenced to SGND, unless otherwise noted.)

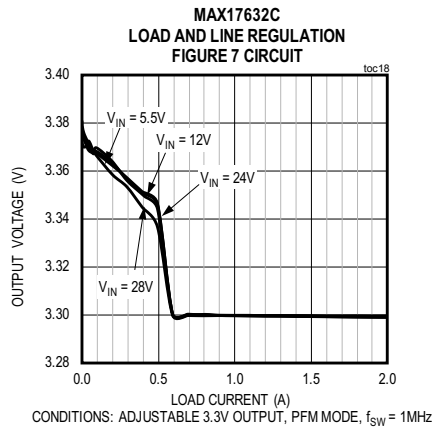
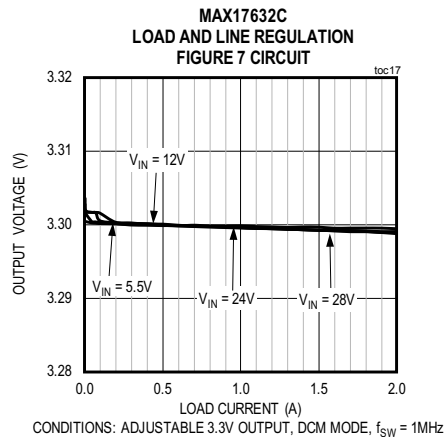
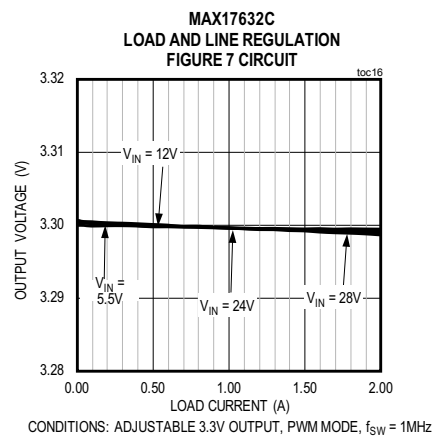
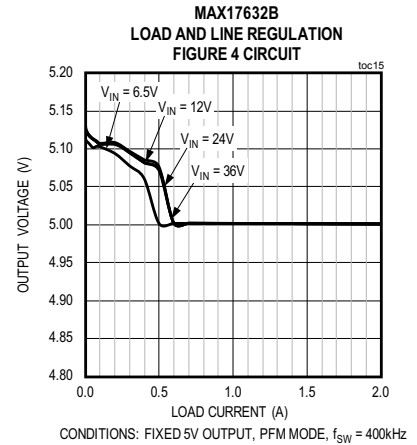
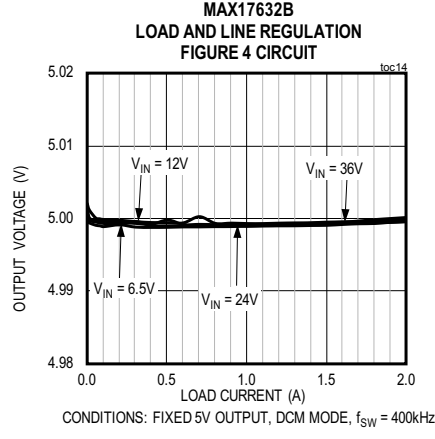
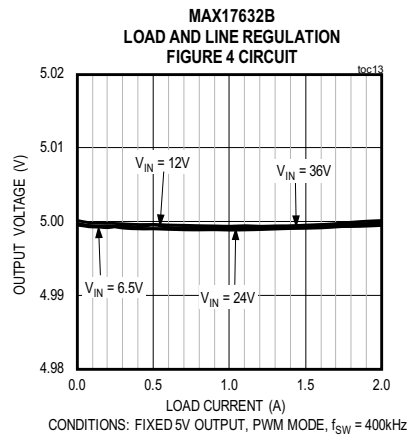
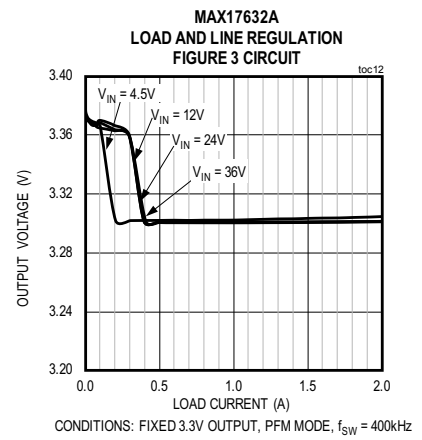
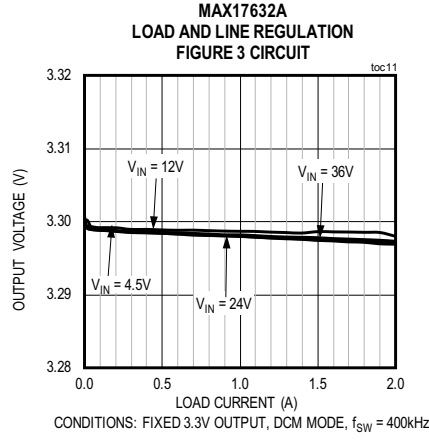
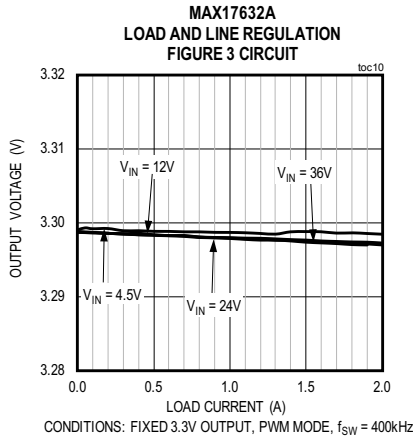

Typical Operating Characteristics (continued)

($V_{EN/UVLO} = V_{IN} = 24V$, $V_{SGND} = V_{PGND} = 0V$, $C_{VCC} = 2.2\mu F$, $C_{BST} = 0.1\mu F$, $C_{SS} = 5600pF$, $T_A = -40^{\circ}C$ to $+125^{\circ}C$, unless otherwise noted. Typical values are at $T_A = +25^{\circ}C$. All voltages are referenced to SGND, unless otherwise noted.)

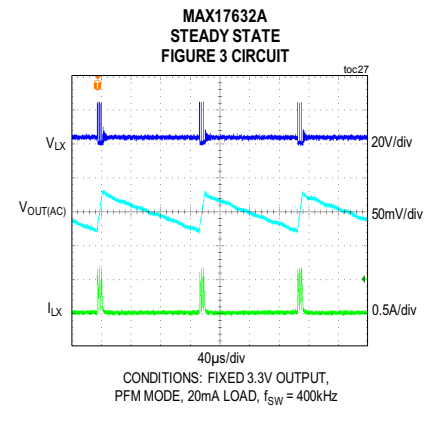
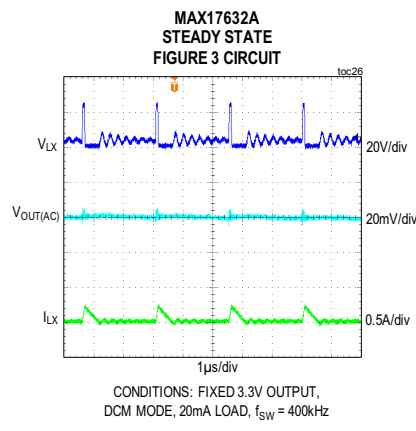
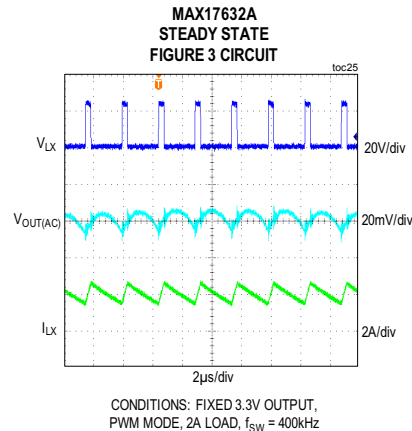
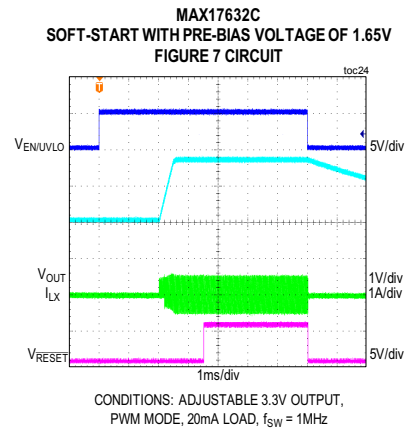
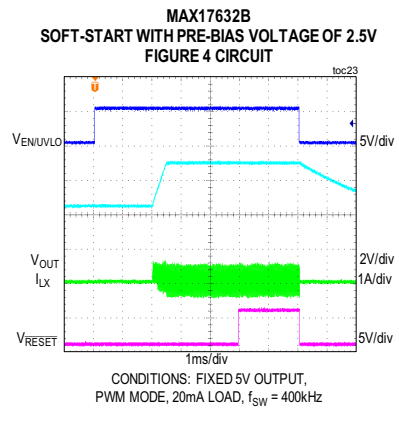
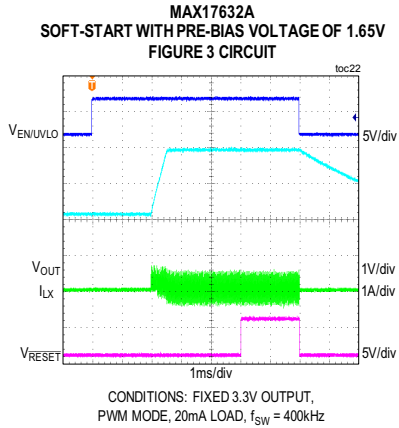
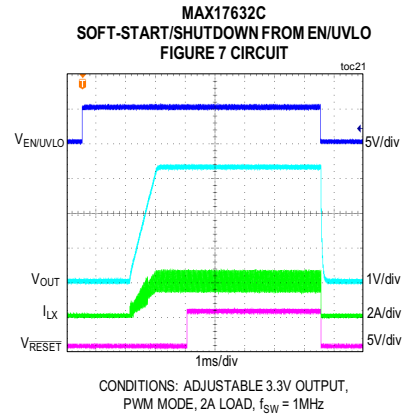
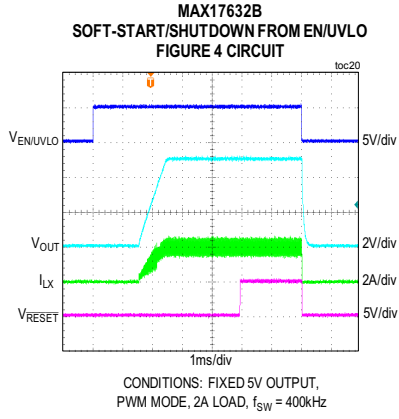
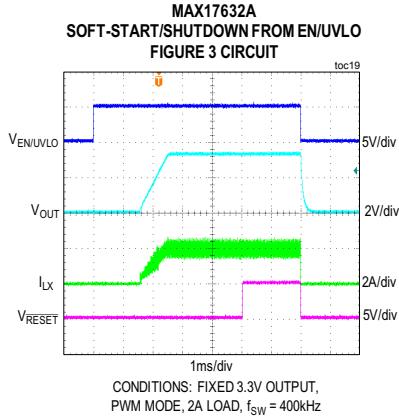

Typical Operating Characteristics (continued)

($V_{EN/UVLO} = V_{IN} = 24V$, $V_{SGND} = V_{PGND} = 0V$, $C_{VCC} = 2.2\mu F$, $C_{BST} = 0.1\mu F$, $C_{SS} = 5600pF$, $T_A = -40^{\circ}C$ to $+125^{\circ}C$, unless otherwise noted. Typical values are at $T_A = +25^{\circ}C$. All voltages are referenced to SGND, unless otherwise noted.)

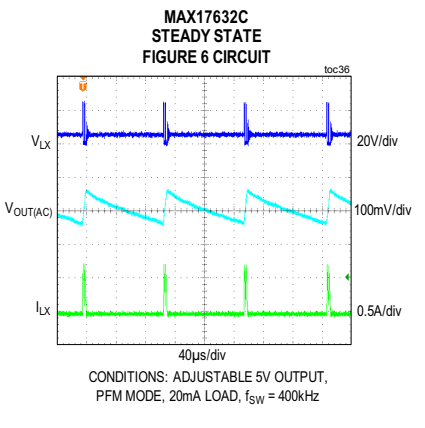
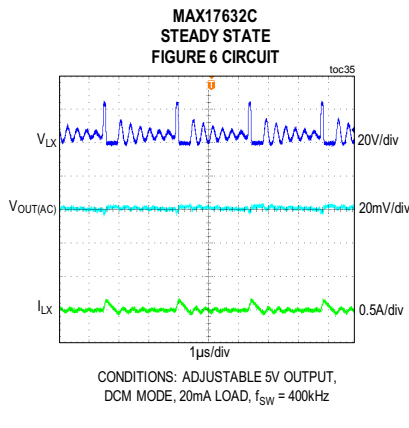
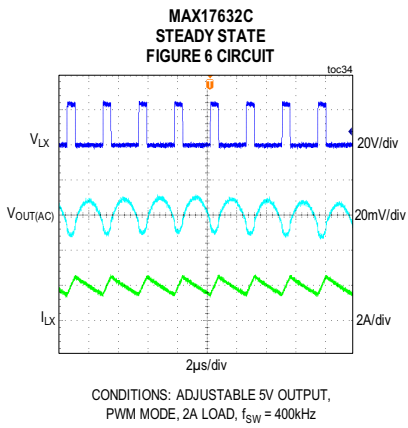
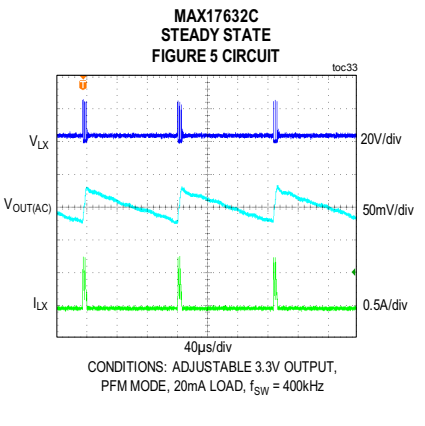
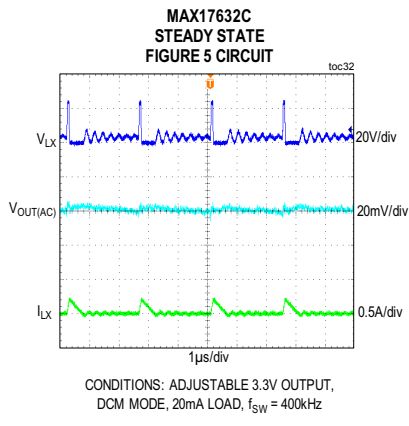
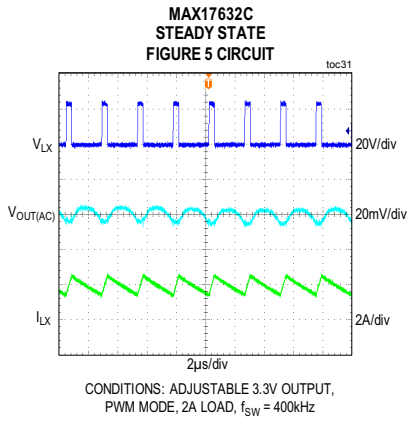
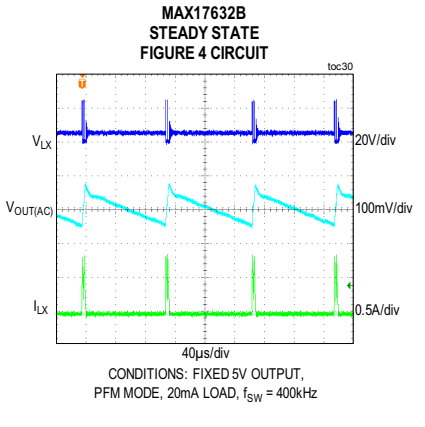
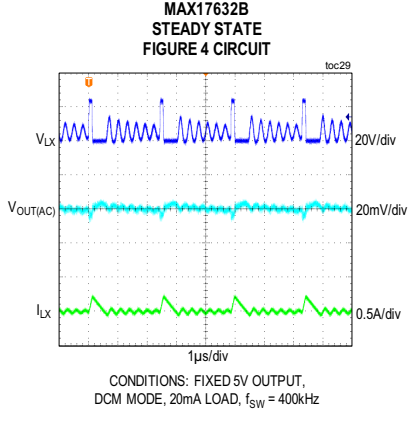
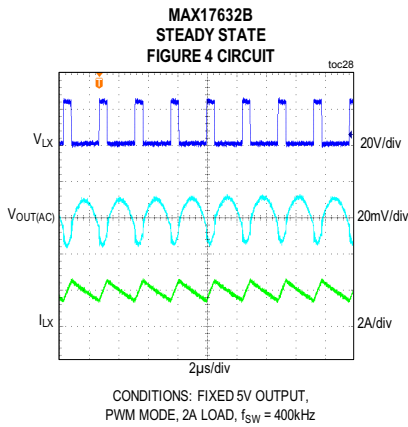

Typical Operating Characteristics (continued)

($V_{EN/UVLO} = V_{IN} = 24V$, $V_{SGND} = V_{PGND} = 0V$, $C_{VCC} = 2.2\mu F$, $C_{BST} = 0.1\mu F$, $C_{SS} = 5600pF$, $T_A = -40^{\circ}C$ to $+125^{\circ}C$, unless otherwise noted. Typical values are at $T_A = +25^{\circ}C$. All voltages are referenced to SGND, unless otherwise noted.)

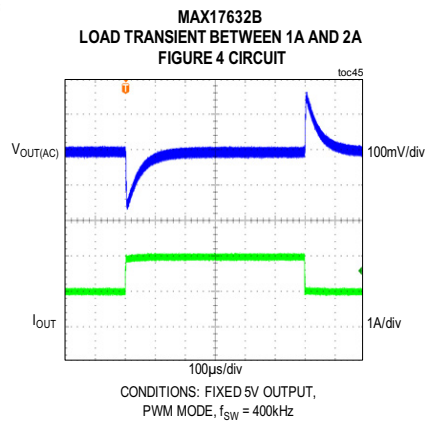
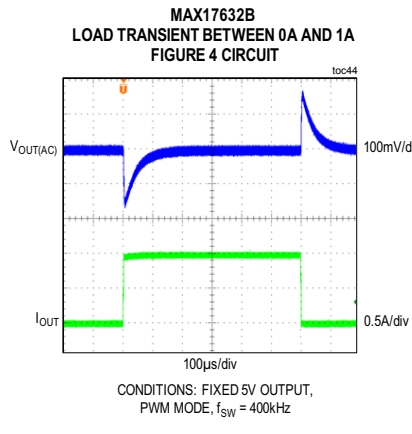
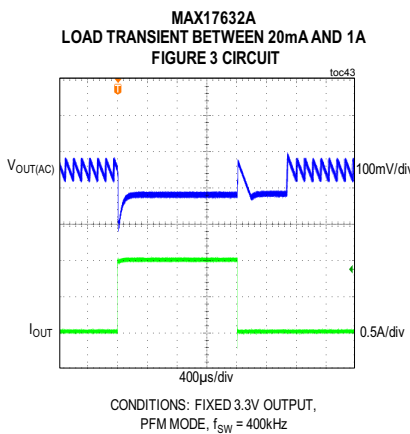
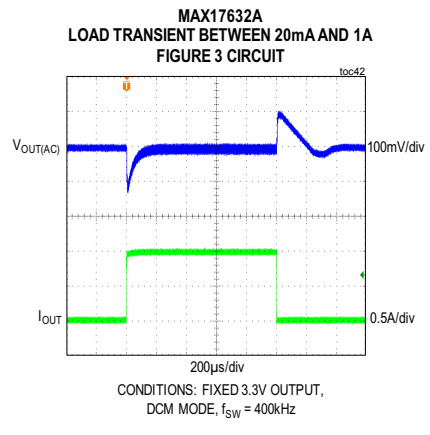
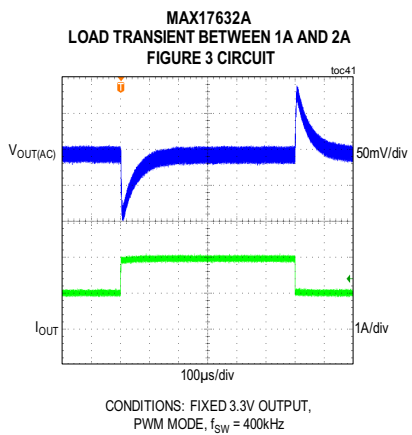
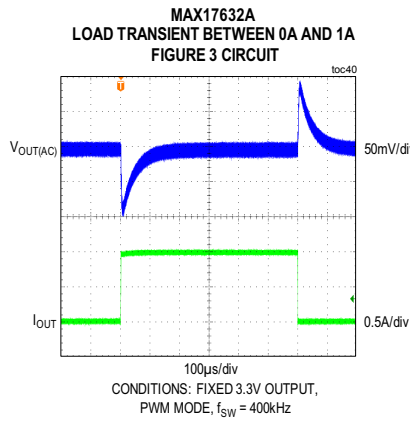
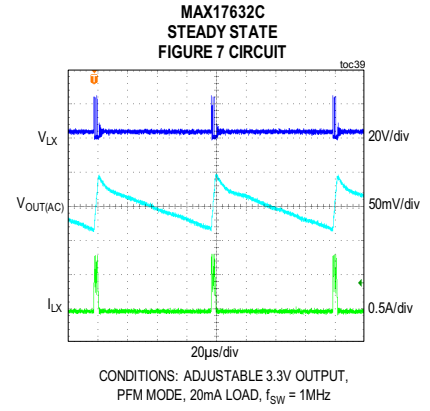
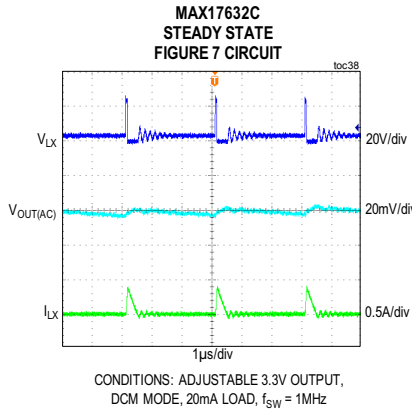
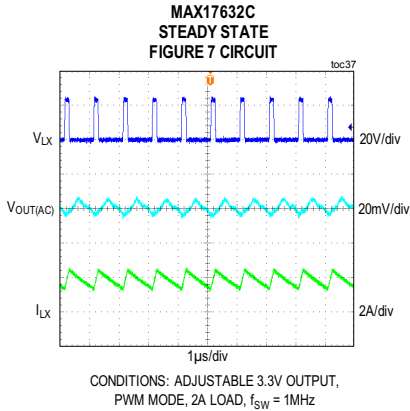

Typical Operating Characteristics (continued)

($V_{EN/UVLO} = V_{IN} = 24V$, $V_{SGND} = V_{PGND} = 0V$, $C_{VCC} = 2.2\mu F$, $C_{BST} = 0.1\mu F$, $C_{SS} = 5600pF$, $T_A = -40^{\circ}C$ to $+125^{\circ}C$, unless otherwise noted. Typical values are at $T_A = +25^{\circ}C$. All voltages are referenced to SGND, unless otherwise noted.)

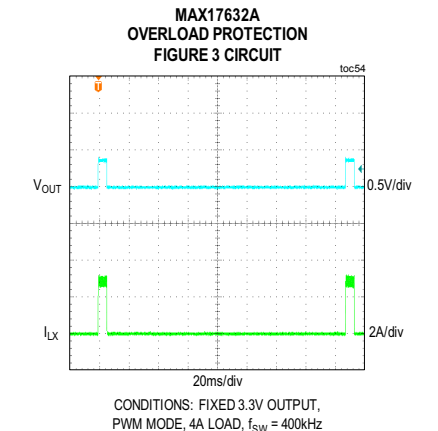
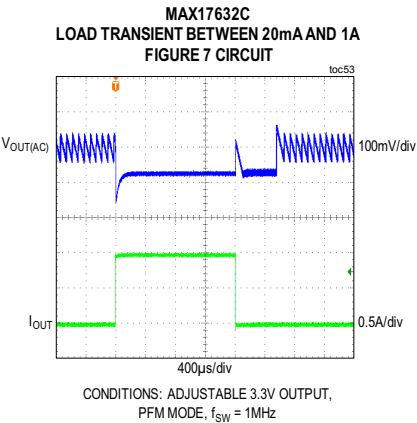
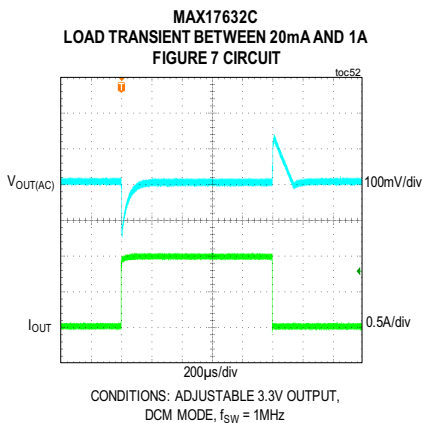
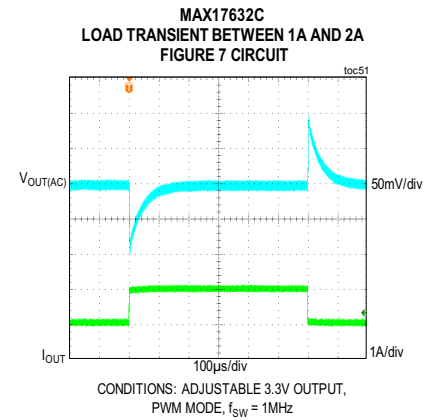
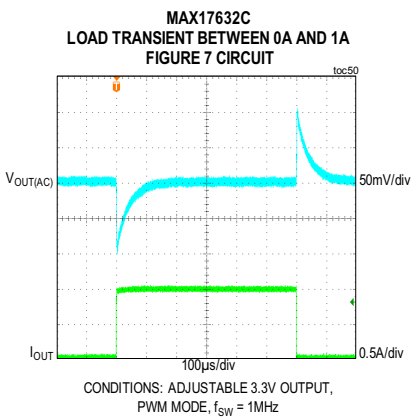
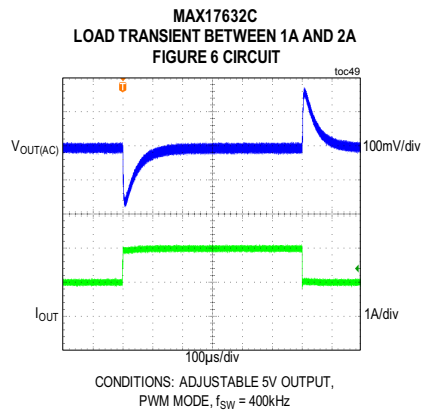
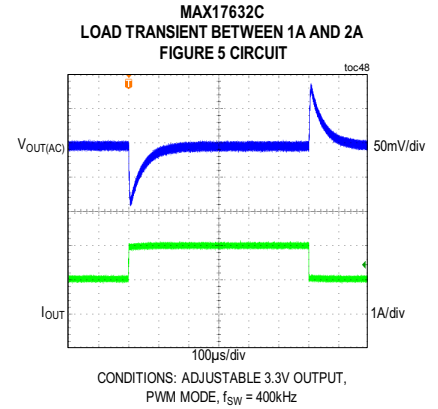
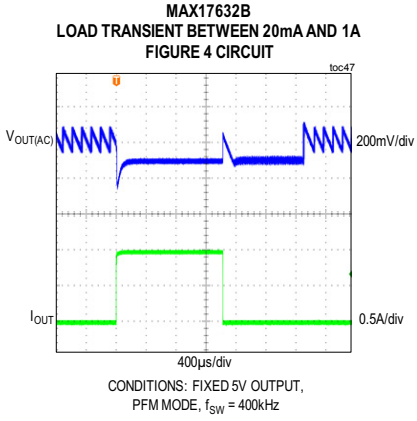
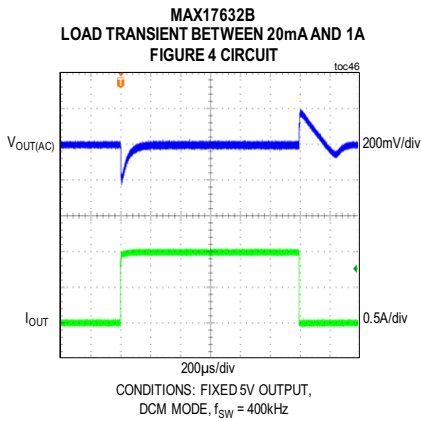

Typical Operating Characteristics (continued)

($V_{EN/UVLO} = V_{IN} = 24V$, $V_{SGND} = V_{PGND} = 0V$, $C_{VCC} = 2.2\mu F$, $C_{BST} = 0.1\mu F$, $C_{SS} = 5600pF$, $T_A = -40^{\circ}C$ to $+125^{\circ}C$, unless otherwise noted. Typical values are at $T_A = +25^{\circ}C$. All voltages are referenced to SGND, unless otherwise noted.)

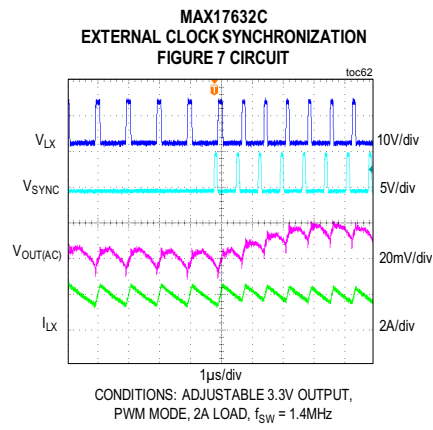
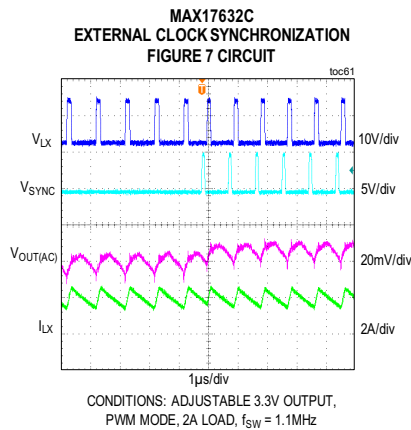
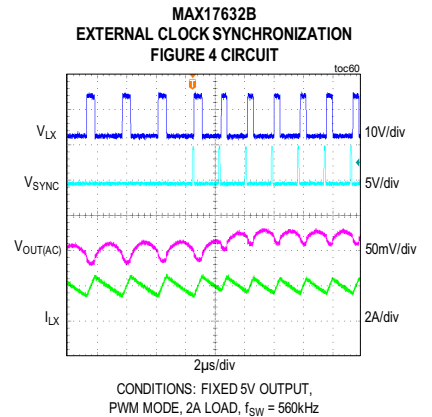
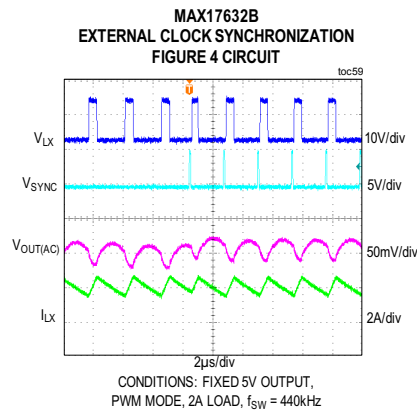
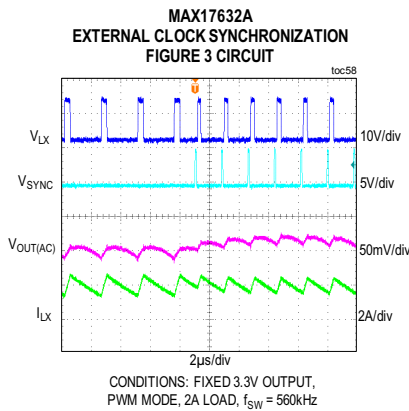
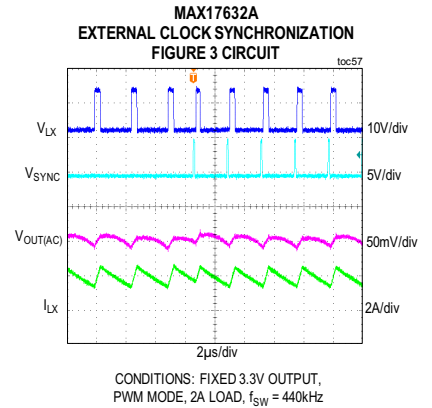
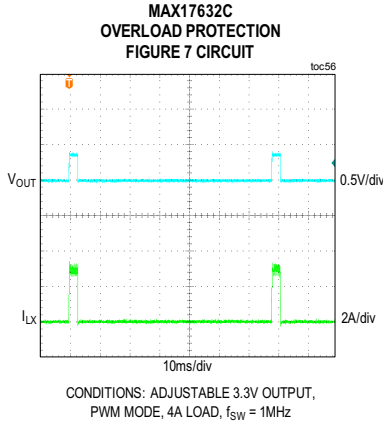
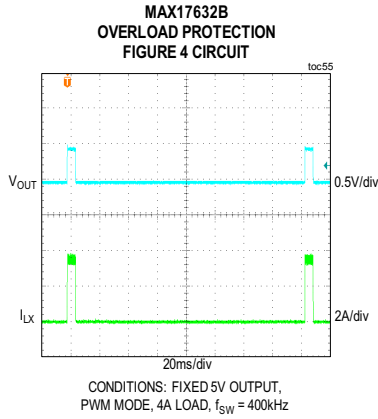

Typical Operating Characteristics (continued)

($V_{EN/UVLO} = V_{IN} = 24V$, $V_{SGND} = V_{PGND} = 0V$, $C_{VCC} = 2.2\mu F$, $C_{BST} = 0.1\mu F$, $C_{SS} = 5600pF$, $T_A = -40^{\circ}C$ to $+125^{\circ}C$, unless otherwise noted. Typical values are at $T_A = +25^{\circ}C$. All voltages are referenced to SGND, unless otherwise noted.)

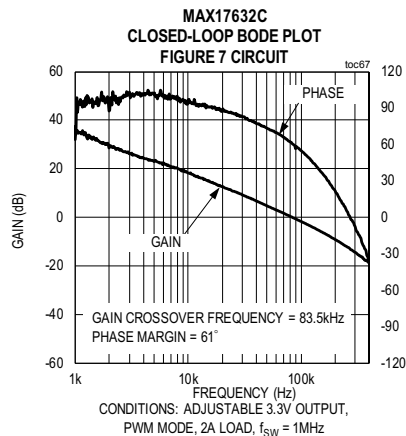
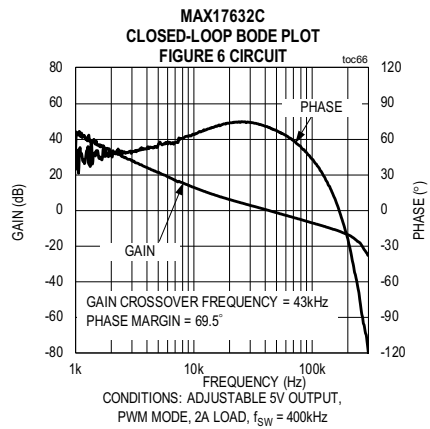
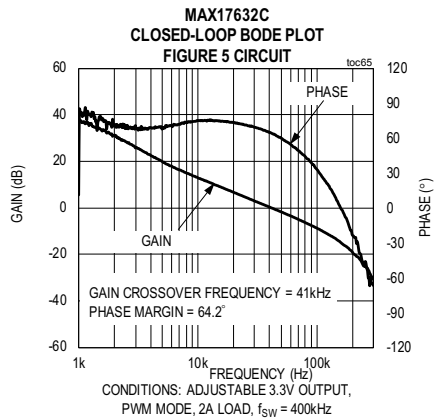
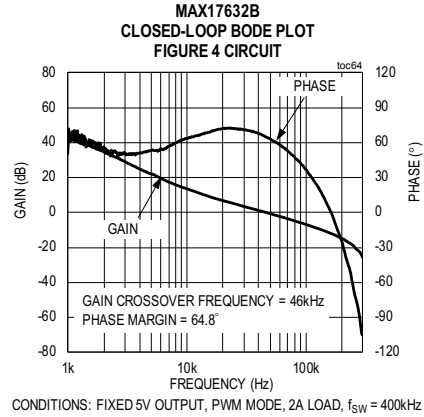
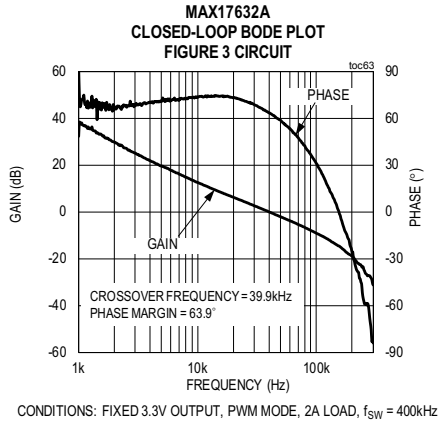

Pin Configuration

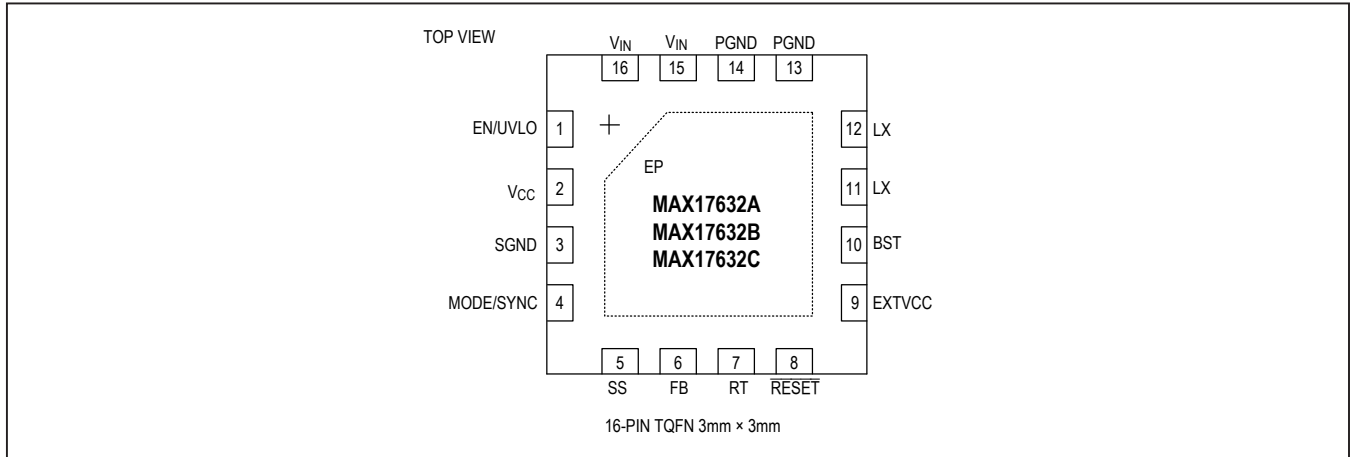

Pin Description

PIN	NAME	FUNCTION
1	EN/UVLO	Enable/Undervoltage Lockout Pin. Drive EN/UVLO high to enable the output. Connect to the center of the resistor-divider between V_{IN} and SGND to set the input voltage at which the part turns on. Connect to V_{IN} pins for always on operation. Pull low for disabling the device.
2	V_{CC}	5V LDO Output. Bypass V_{CC} with a 2.2 μ F ceramic capacitance to SGND.
3	SGND	Analog Ground
4	MODE/SYNC	MODE/SYNC Pin Configures the Device to Operate either in PWM, PFM or DCM Modes of Operation. Leave MODE/SYNC unconnected for PFM operation (pulse skipping at light loads). Connect MODE/SYNC to SGND for constant-frequency PWM operation at all loads. Connect MODE/SYNC to V_{CC} for DCM operation at light loads. The device can be synchronized to an external clock using this pin. See the Mode Selection and External Synchronization (MODE/SYNC) section for more details.
5	SS	Soft-Start Input. Connect a capacitor from SS to SGND to set the soft-start time.
6	FB	Feedback Input. Connect the output voltage node (V_{OUT}) to FB for MAX17632A and MAX17632B. Connect FB to the center node of an external resistor-divider from the output to SGND to set the output voltage for MAX17632C. See the Adjusting Output Voltage section for more details.
7	RT	Connect a resistor from RT to SGND to set the regulator's switching frequency between 400kHz and 2.2MHz. Leave RT open for the default 400kHz frequency. See the Setting the Switching Frequency (RT) section for more details.
8	RESET	Open-Drain RESET Output. The RESET output is driven low if FB drops below 92% of its set value. RESET goes high 1024 cycles after FB rises above 95% of its set value.
9	EXTVCC	External Power Supply Input Reduces the Internal-LDO loss. Connect it to buck output when it is programmed to 5V only. When EXTVCC is not used, connect it to SGND.
10	BST	Boost Flying Capacitor. Connect a 0.1 μ F ceramic capacitor between BST and LX.
11, 12	LX	Switching Node Pins. Connect LX pins to the switching side of the inductor.
13, 14	PGND	Power Ground Pins of the Converter. Connect externally to the power ground plane. Refer to the MAX17632 Evaluation Kit data sheet for a layout example.
15, 16	V_{IN}	Power-Supply Input Pins. 4.5V to 36V input-supply range. Decouple to PGND with a 2.2 μ F capacitor; place the capacitor close to the V_{IN} and PGND pins.
-	EP	Exposed Pad. Always connect EP to the SGND pin of the IC. Also, connect EP to a large SGND plane with several thermal vias for best thermal performance. Refer to the MAX17632 EVKit data sheet for an example of the correct method for EP connection and thermal vias.

Functional Diagrams

Block Diagram

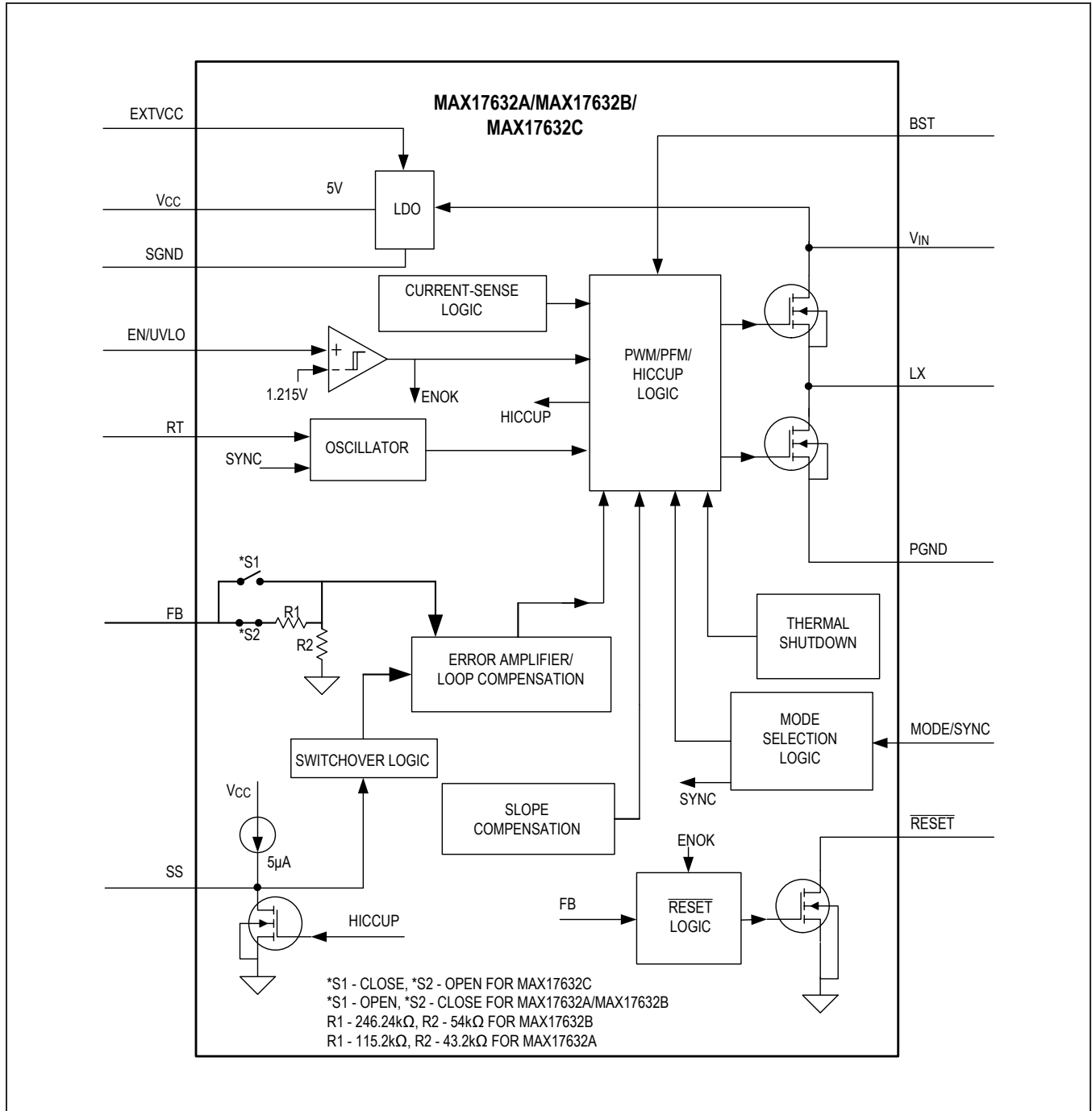

Detailed Description

The MAX17632 family of devices (MAX17632A, MAX17632B and MAX17632C) is a high-efficiency, high-voltage, synchronous step-down DC-DC converter with integrated MOSFETs operating over an input-voltage range of 4.5V to 36V. It can deliver up to 2A current. MAX17632A and MAX17632B are fixed 3.3V and fixed 5V output parts, respectively. MAX17632C is the adjustable output voltage (0.9V to 90% of V_{IN}) part. Built-in compensation across the output-voltage range eliminates the need for external compensation components. The feedback-voltage regulation accuracy over -40°C to $+125^{\circ}\text{C}$ is $\pm 1.2\%$ for MAX17632A/MAX17632B/MAX17632C.

The device features a peak-current-mode control architecture. An internal transconductance error amplifier produces an integrated error voltage at an internal node, which sets the duty cycle using a PWM comparator, a high-side current-sense amplifier, and a slope-compensation generator. At each rising edge of the clock, the high-side MOSFET turns on and remains on until either the appropriate or maximum duty cycle is reached, or the peak current limit is detected. During the high-side MOSFET's on-time, the inductor current ramps up. During the second half of the switching cycle, the high-side MOSFET turns off and the low-side MOSFET turns on. The inductor releases the stored energy as its current ramps down and provides current to the output.

The device features a MODE/SYNC pin that can be used to operate the device in PWM, or PFM, or DCM control modes. The device integrates adjustable-input undervoltage lockout, adjustable soft-start, open-drain $\overline{\text{RESET}}$, and external frequency synchronization features. The MAX17632 offers a low minimum ON time that allows high switching frequencies and a smaller solution size.

Mode Selection and External Synchronization (MODE/SYNC)

The logic state of the MODE/SYNC pin is latched when V_{CC} and EN/UVLO voltages exceed the respective UVLO rising thresholds and all internal voltages are ready to allow LX switching. If the state of the MODE/SYNC pin is open at power-up, the device operates in PFM mode at light loads. If the state of the MODE/SYNC pin is low (connected to SGND) at power-up, the device operates in constant-frequency PWM mode at all loads. If the state of the MODE/SYNC pin is high (connected to V_{CC}) at power-up, the device operates in constant-frequency DCM mode at light loads. State changes on the MODE/SYNC pin are ignored during normal operation.

The internal oscillator of the device can be synchronized to an external clock signal through the MODE/SYNC pin. The external synchronization clock frequency must be between $1.1 \times f_{SW}$ and $1.4 \times f_{SW}$, where f_{SW} is the switching frequency programmed by the resistor connected at the RT pin. When an external clock is applied to the MODE/SYNC pin, the internal oscillator frequency changes to the external clock frequency (from the original frequency based on RT setting). The minimum external clock pulse-width should be greater than 50ns. See the [MODE/SYNC](#) section in the [Electrical Characteristics](#) table for details.

PWM Mode Operation

In PWM mode, the inductor current is allowed to go negative. PWM operation provides constant frequency operation at all loads, and is useful in applications sensitive to switching frequency. However, the PWM mode of operation gives lower efficiency at light loads compared to PFM and DCM modes of operation.

PFM Mode Operation

PFM mode of operation disables negative inductor current and additionally skips pulses at light loads for high efficiency. In PFM mode, the inductor current is forced to a fixed peak of I_{PFM} (800mA (typ)) every clock cycle until the output rises to 102.3% of the set nominal output voltage. Once the output reaches 102.3% of the set nominal output voltage, both the high-side and low-side FETs are turned off and the device enters hibernate operation until the load discharges the output to 101.1% of the set nominal output voltage. Most of the internal blocks are turned off in hibernate operation to save quiescent current. After the output falls below 101.1% of the set nominal output voltage, the device comes out of hibernate operation, turns on all internal blocks, and again commences the process of delivering pulses of energy to the output until it reaches 102.3% of the set nominal output voltage. The advantage of the PFM mode is higher efficiency at light loads because of lower quiescent current drawn from supply. The disadvantage is that the output-voltage ripple is higher compared to PWM or DCM modes of operation and switching frequency is not constant at light loads.

DCM Mode Operation

DCM mode of operation features constant frequency operation down to lighter loads than PFM mode, not by skipping pulses, but by disabling negative inductor current at light loads. DCM operation offers efficiency performance that lies between PWM and PFM modes. The output-voltage ripple in DCM mode is comparable to PWM mode and relatively lower compared to PFM mode.

Linear Regulator (V_{CC} and EXTVCC)

The MAX17632 has an internal low dropout (LDO) regulator that powers V_{CC} from V_{IN}. This LDO is enabled during power-up or when EN/UVLO is recycled. When V_{CC} is above its UVLO, if EXTVCC is greater than 4.7V (typ), internal V_{CC} is powered by EXTVCC and LDO is disabled from V_{IN}. Powering V_{CC} from EXTVCC increases efficiency at higher input voltages. The typical V_{CC} output voltage is 5V. Bypass V_{CC} to SGND with a 2.2µF low-ESR ceramic capacitor. V_{CC} powers the internal blocks and the low-side MOSFET driver and recharges the external bootstrap capacitor.

The MAX17632 employs an undervoltage-lockout circuit that forces the regulator off when V_{CC} falls below V_{CC_UVF}. The regulator can be immediately enabled again when V_{CC} > V_{CC_UVR}. The 400mV UVLO hysteresis prevents chattering on power-up/power-down.

In applications where the buck-converter output is connected to the EXTVCC pin, if the output is shorted to ground, then the transfer from EXTVCC to internal LDO happens seamlessly without any impact to the normal functionality. Connect EXTVCC pin to SGND, when not in use.

Setting the Switching Frequency (RT)

The switching frequency of the device can be programmed from 400kHz to 2.2MHz by using a resistor connected from the RT pin to SGND. The switching frequency (f_{SW}) is related to the resistor connected at the RT pin (R_{RT}) by the following equation:

$$R_{RT} = \frac{21000}{f_{SW}} - 1.7$$

Where R_{RT} is in kΩ and f_{SW} is in kHz. Leaving the RT pin open makes the device operate at the default switching frequency of 400kHz. See [Table 1](#) for RT resistor values for a few common switching frequencies.

Table 1. Switching Frequency vs. RT Resistor

SWITCHING FREQUENCY (KHZ)	RT RESISTOR (KΩ)
400	Open
400	50.8
500	40.2
2200	8.06

Operating Input-Voltage Range

The minimum and maximum operating input voltages for a given output voltage setting should be calculated as follows:

$$V_{IN(MIN)} = \frac{V_{OUT} + (I_{OUT(MAX)} \times (R_{DCR(MAX)} + R_{DS-ONL(MAX)}))}{1 - (f_{SW(MAX)} \times t_{OFF-MIN(MAX)})} + (I_{OUT(MAX)} \times (R_{DS-ONH(MAX)} - R_{DS-ONL(MAX)}))$$

$$V_{IN(MAX)} = \frac{V_{OUT}}{f_{SW(MAX)} \times t_{ON-MIN(MAX)}}$$

where:

V_{OUT} = Steady-state output voltage

I_{OUT(MAX)} = Maximum load current

R_{DCR(MAX)} = Worst-case DC resistance of the inductor

f_{SW(MAX)} = Maximum switching frequency

t_{OFF-MIN(MAX)} = Worst-case minimum switch off-time (160ns)

t_{ON-MIN(MAX)} = Worst-case minimum switch on-time (80ns)

R_{DS-ONL(MAX)} and R_{DS-ONH(MAX)} = Worst-case on-time resistances of low-side and high-side internal MOSFETs, respectively.

Overcurrent Protection (OCP)/Hiccup Mode

The device is provided with a robust overcurrent-protection (OCP) scheme that protects the device under overload and output short-circuit conditions. A cycle-by-cycle peak current limit turns off the high-side MOSFET whenever the high-side switch current exceeds an internal limit of I_{PEAK-LIMIT} (3.15A (typ)). A runaway peak current limit on the high-side switch current at I_{RUNAWAY-LIMIT} (3.6A (typ)) protects the device under high input voltage, short-circuit conditions when there is insufficient output voltage available to restore the inductor current that built up during the on period of the step-down converter. One occurrence of the runaway current limit triggers a hiccup mode. In addition, if, due to a fault condition, feedback voltage drops to V_{FB-HICF} any time after soft-start is complete and hiccup mode is triggered. In hiccup mode, the converter is protected by suspending switching for a hiccup timeout period of 32,768 clock cycles of half the programmed switching frequency. Once the hiccup timeout period expires, soft-start is attempted again. Note that when soft-start is attempted under overload condition, if feedback voltage

does not exceed $V_{FB-HICP}$, the device continues to switch at half the programmed switching frequency for the time duration of the programmed soft-start time and 1024 clock cycles. Hiccup mode of operation ensures low power dissipation under output short-circuit conditions.

RESET Output

The device includes a $\overline{\text{RESET}}$ comparator to monitor the output voltage. The open-drain $\overline{\text{RESET}}$ output requires an external pullup resistor. $\overline{\text{RESET}}$ goes high (high impedance) 1024 switching cycles after the regulator output increases above 95% of the designed nominal regulated voltage. $\overline{\text{RESET}}$ goes low when the regulator output voltage drops to below 92% of the nominal regulated voltage. $\overline{\text{RESET}}$ also goes low during thermal shutdown or when the EN/UVLO pin goes below V_{ENF} .

Prebiased Output

When the device starts into a prebiased output, both the high-side and the low-side switches are turned off so that the converter does not sink current from the output. High-side and low-side switches do not start switching until the PWM comparator commands the first PWM pulse, at which point switching commences. The output voltage is then smoothly ramped up to the target value in alignment with the internal reference.

Thermal-Shutdown Protection

Thermal-shutdown protection limits junction temperature of the device. When the junction temperature of the device exceeds +165°C, an on-chip thermal sensor shuts down the device, allowing the device to cool. The thermal sensor turns the device on again after the junction temperature cools by 10°C. Soft-start resets during thermal shutdown. Carefully evaluate the total power dissipation (see the [Power Dissipation](#) section) to avoid unwanted triggering of the thermal shutdown during normal operation.

Applications Information

Input Capacitor Selection

The input filter capacitor reduces peak currents drawn from the power source and reduces noise and voltage ripple on the input caused by the circuit's switching. The input capacitor RMS current requirement (I_{RMS}) is defined by the following equation:

$$I_{\text{RMS}} = I_{\text{OUT(MAX)}} \times \frac{\sqrt{V_{\text{OUT}} \times (V_{\text{IN}} - V_{\text{OUT}})}}{V_{\text{IN}}}$$

where, $I_{\text{OUT(MAX)}}$ is the maximum load current. I_{RMS} has a maximum value when the input voltage equals twice the output voltage ($V_{\text{IN}} = 2 \times V_{\text{OUT}}$), so

$$I_{\text{RMS(MAX)}} = \frac{I_{\text{OUT(MAX)}}}{2}$$

Choose an input capacitor that exhibits less than +10°C temperature rise at the RMS input current for optimal long-term reliability. Use low-ESR ceramic capacitors with high-ripple-current capability at the input. X7R capacitors are recommended in industrial applications for their temperature stability. Calculate the input capacitance using the following equation:

$$C_{\text{IN}} = \frac{I_{\text{OUT(MAX)}} \times D \times (1-D)}{\eta \times f_{\text{SW}} \times \Delta V_{\text{IN}}}$$

where:

$D = V_{\text{OUT}}/V_{\text{IN}}$ is the duty ratio of the controller

f_{SW} = switching frequency

ΔV_{IN} = allowable input-voltage ripple

η = efficiency

In applications where the source is located distant from the device input, an appropriate electrolytic capacitor should be added in parallel to the ceramic capacitor to provide necessary damping for potential oscillations caused by the inductance of the longer input power path and input ceramic capacitor.

Inductor Selection

Three key inductor parameters must be specified for operation with the device: inductance value (L), inductor saturation current (I_{SAT}) and DC resistance (R_{DCR}). The switching frequency and output voltage determine the inductor value as follows:

$$\text{For PWM/DCM mode, } L = \frac{V_{\text{OUT}}}{1.25 \times f_{\text{SW}}}$$

$$\text{For PFM mode, } L = \frac{V_{\text{OUT}}}{0.833 \times f_{\text{SW}}}$$

where V_{OUT} and f_{SW} are nominal values and f_{SW} is in Hz. Select an inductor whose value is nearest to the value calculated by the previous formula. Select a low-loss inductor closest to the calculated value with acceptable dimensions and having the lowest possible DC resistance. The saturation current rating (I_{SAT}) of the inductor must be high enough to ensure that saturation can occur only above the peak current-limit value of $I_{\text{PEAK-LIMIT}}$.

Output-Capacitor Selection

X7R ceramic output capacitors are preferred due to their stability over temperature in industrial applications. The output capacitors are usually sized to support a step load of 50% of the maximum output current in the application, so the output-voltage deviation is contained to 3% of the output-voltage change. The minimum required output capacitance can be calculated as follows:

$$C_{OUT} = \frac{1}{2} \times \frac{I_{STEP} \times t_{RESPONSE}}{\Delta V_{OUT}}$$

$$t_{RESPONSE} \cong \frac{0.33}{f_C}$$

where:

I_{STEP} = Load current step

$t_{RESPONSE}$ = Response time of the controller

ΔV_{OUT} = Allowable output-voltage deviation

f_C = Target closed-loop crossover frequency

f_{SW} = Switching frequency.

Select f_C to be 1/10th of f_{SW} if the switching frequency is less than or equal to 800kHz. If the switching frequency is more than 800kHz, select f_C to be 80kHz. Actual derating of ceramic capacitors with DC-voltage must be considered while selecting the output capacitor. Derating curves are available from all major ceramic capacitor vendors.

Soft-Start Capacitor Selection

The device implements adjustable soft-start operation to reduce inrush current. A capacitor connected from the SS pin to SGND programs the soft-start time. The selected output capacitance (C_{SEL}) and the output voltage (V_{OUT}) determine the minimum required soft-start capacitor as follows:

$$C_{SS} \geq 28 \times 10^{-6} \times C_{SEL} \times V_{OUT}$$

The soft-start time (t_{SS}) is related to the capacitor connected at SS (C_{SS}) by the following equation:

$$t_{SS} = \frac{C_{SS}}{5.55 \times 10^{-6}}$$

For example, to program a 1ms soft-start time, a 5.6nF capacitor should be connected from the SS pin to SGND. Note that during start-up, the device operates at half the programmed switching frequency until the output voltage reaches 64.4% of set output nominal voltage.

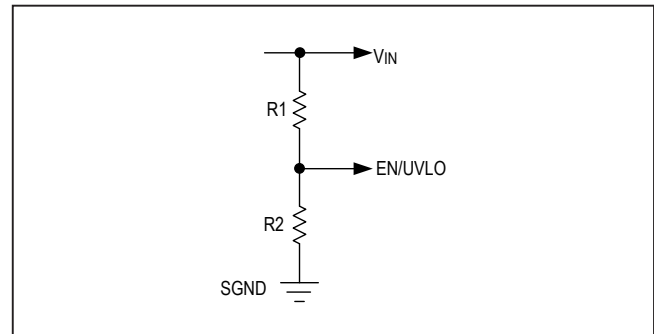

Figure 1. Setting the Input Undervoltage Lockout

Setting the Input Undervoltage-Lockout Level

The device offers an adjustable input undervoltage-lockout level. Set the voltage at which the device turns on with a resistive voltage-divider connected from V_{IN} to SGND. Connect the center node of the divider to EN/UVLO. Choose R1 to be 3.3M Ω and then calculate R2 as follows:

$$R2 = \frac{R1 \times 1.215}{(V_{INU} - 1.215)}$$

where V_{INU} is the input-voltage level at which the device is required to turn on. Ensure that V_{INU} is higher than $0.8 \times V_{OUT}$. If the EN/UVLO pin is driven from an external signal source, a series resistance of minimum 1k Ω is recommended to be placed between the output pin of signal source and the EN/UVLO pin, to reduce voltage ringing on the line.

Adjusting Output Voltage

Set the output voltage with a resistive voltage-divider connected from the output-voltage node (V_{OUT}) to SGND (see Figure 2). Connect the center node of the divider to the FB pin for MAX17632C. Connect output voltage node (V_{OUT}) to FB pin for MAX17632A and MAX17632B. Use the following procedure to choose the resistive voltage-divider values:

Calculate resistor R6 from the output to the FB pin as follows:

$$R6 = \frac{216}{(f_C \times C_{OUT})}$$

where:

R6 is in k Ω

f_C = Crossover frequency is in Hz

C_{OUT} = Actual capacitance of output capacitor in F.

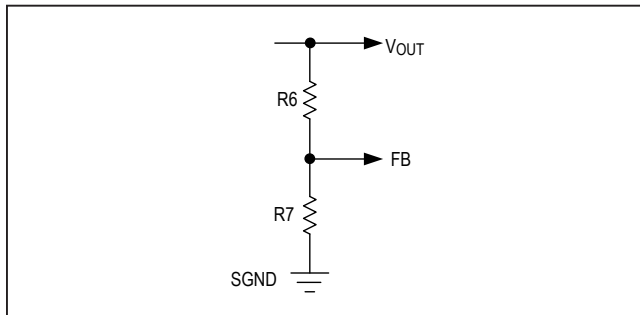

Figure 2. Setting the Output Voltage

Calculate resistor R7 from the FB pin to SGND as follows:

$$R7 = \frac{R6 \times 0.9}{(V_{OUT} - 0.9)}$$

R7 is in k Ω .

Power Dissipation

At a particular operating condition, the power losses that lead to temperature rise of the part are estimated as follows:

$$P_{LOSS} = \left(P_{OUT} \times \left(\frac{1}{\eta} - 1 \right) \right) - (I_{OUT}^2 \times R_{DCR})$$

$$P_{OUT} = V_{OUT} \times I_{OUT}$$

where:

P_{OUT} = Output power

η = Efficiency of the converter

R_{DCR} = DC resistance of the inductor (see the Typical Operating Characteristics for more information on efficiency at typical operating conditions).

For a typical multilayer board, the thermal performance metrics for the package are given below:

$$\theta_{JA} = 38^\circ\text{C/W}$$

$$\theta_{JC} = 10^\circ\text{C/W}$$

The junction temperature of the device can be estimated at any given maximum ambient temperature ($T_{A(MAX)}$) from the following equation:

$$T_{J(MAX)} = T_{A(MAX)} + (\theta_{JA} \times P_{LOSS})$$

If the application has a thermal-management system that ensures that the exposed pad of the device is maintained at a given temperature ($T_{EP(MAX)}$) by using proper heat sinks, then the junction temperature of the device can be estimated at any given maximum ambient temperature as:

$$T_{J(MAX)} = T_{EP(MAX)} + (\theta_{JC} \times P_{LOSS})$$

Note: Junction temperatures greater than +125°C degrades operating lifetimes.

PCB Layout Guidelines

All connections carrying pulsed currents must be very short and as wide as possible. The inductance of these connections must be kept to an absolute minimum due to the high di/dt of the currents. Since inductance of a current-carrying loop is proportional to the area enclosed by the loop, if the loop area is made very small, inductance is reduced. Additionally, small-current loop areas reduce radiated EMI.

A ceramic input filter capacitor should be placed close to the V_{IN} pins of the IC. This eliminates as much trace inductance effects as possible and gives the IC a cleaner voltage supply. A bypass capacitor for the V_{CC} pin also should be placed close to the pin to reduce effects of trace impedance.

When routing the circuitry around the IC, the analog small signal ground and the power ground for switching currents must be kept separate. They should be connected together at a point where switching activity is minimum. This helps keep the analog ground quiet. The ground plane should be kept continuous (unbroken) as far as possible. No trace carrying high switching current should be placed directly over any ground plane discontinuity.

PCB layout also affects the thermal performance of the design. A number of thermal throughputs that connect to a large ground plane should be provided under the exposed pad of the part, for efficient heat dissipation.

For a sample layout that ensures first pass success, refer to the MAX17632 evaluation kit layout available at www.maximintegrated.com.

Typical Application Circuits

Typical Application Circuit — Fixed 3.3V Output

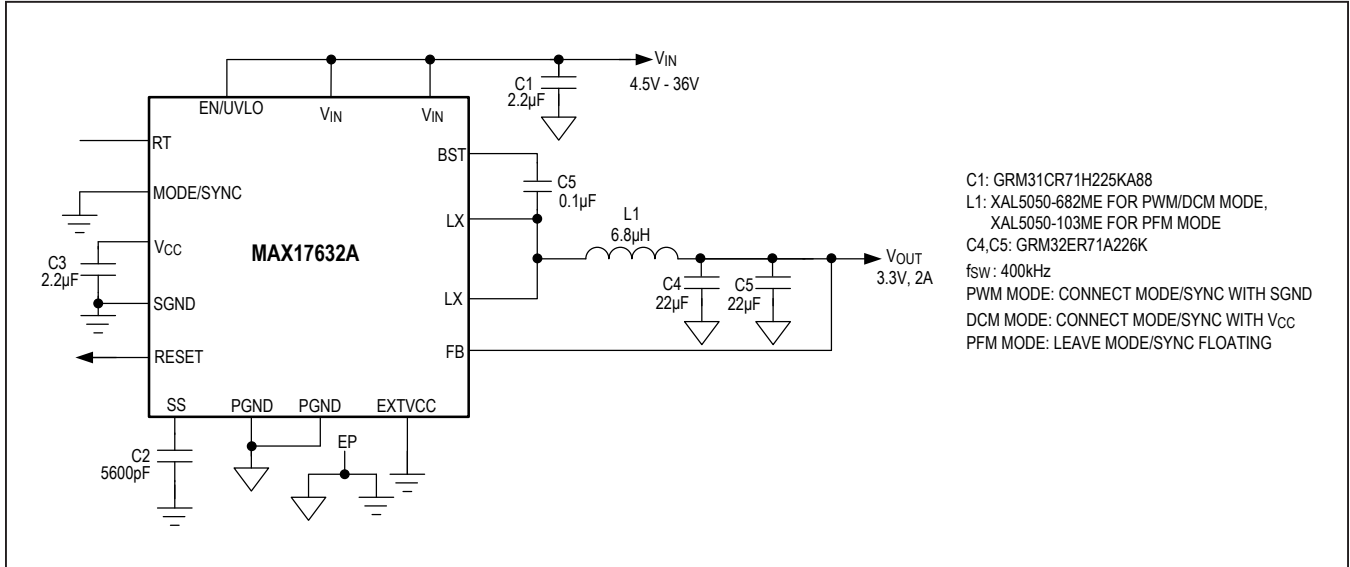

Figure 3. Fixed 3.3V Output with 400kHz Switching Frequency

Typical Application Circuit — Fixed 5V Output

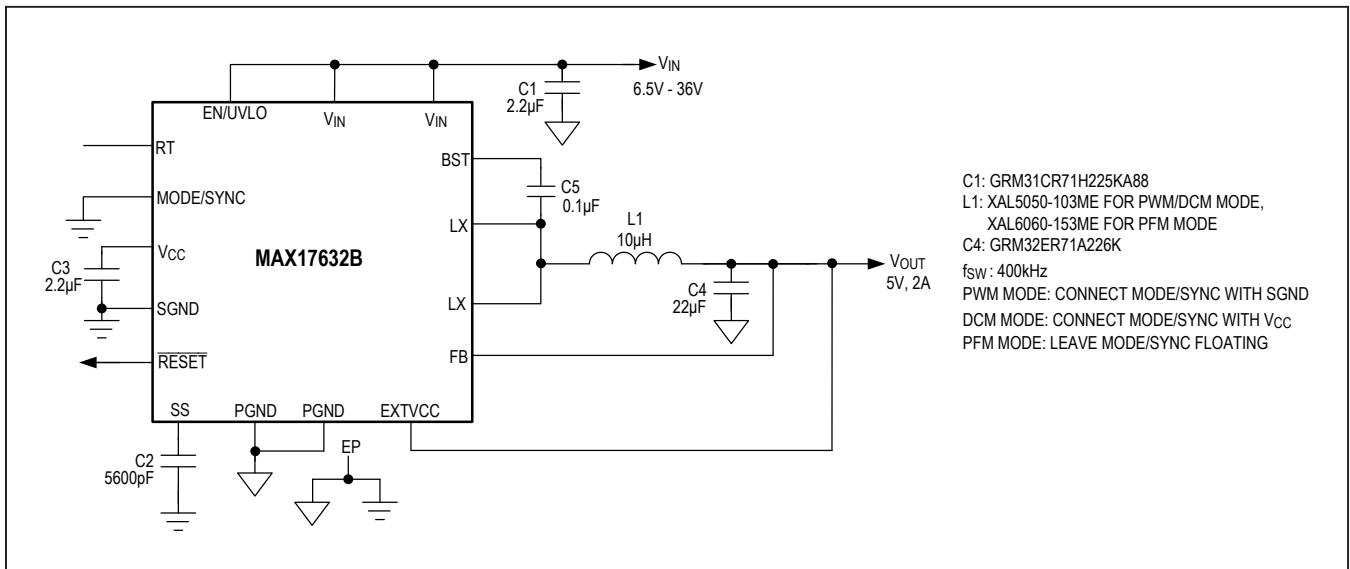

Figure 4. Fixed 5V Output with 400kHz Switching Frequency

Typical Application Circuits (continued)

Typical Application Circuit — Adjustable 3.3V Output

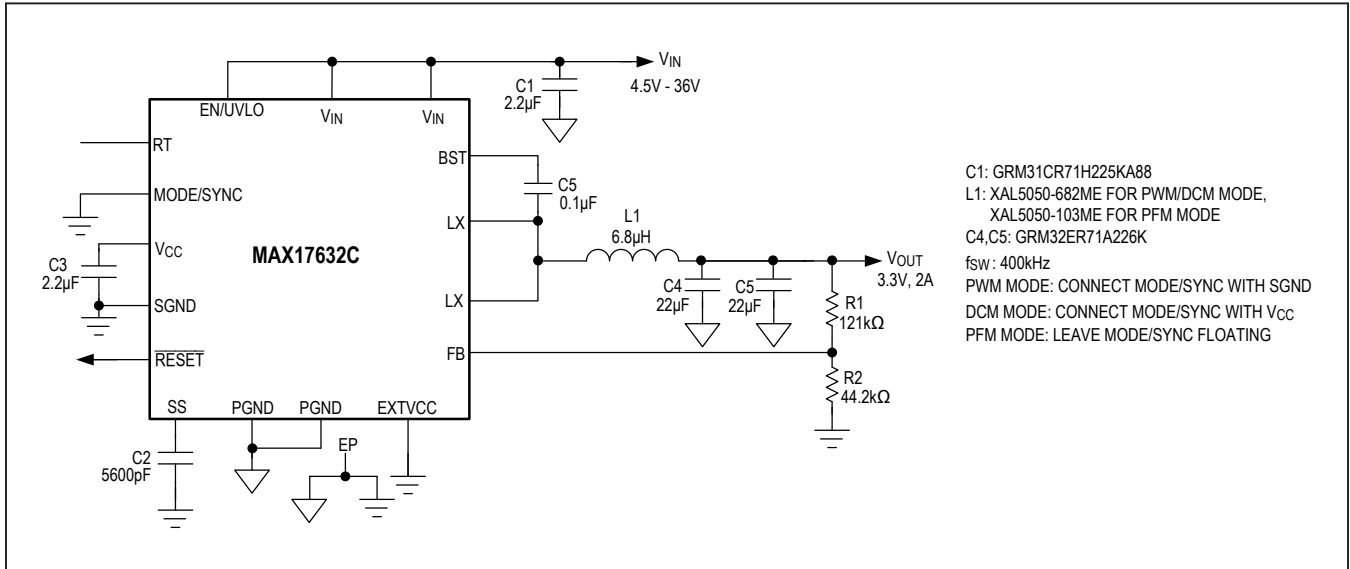

Figure 5. Adjustable 3.3V Output with 400kHz Switching Frequency

Typical Application Circuit — Adjustable 5V Output

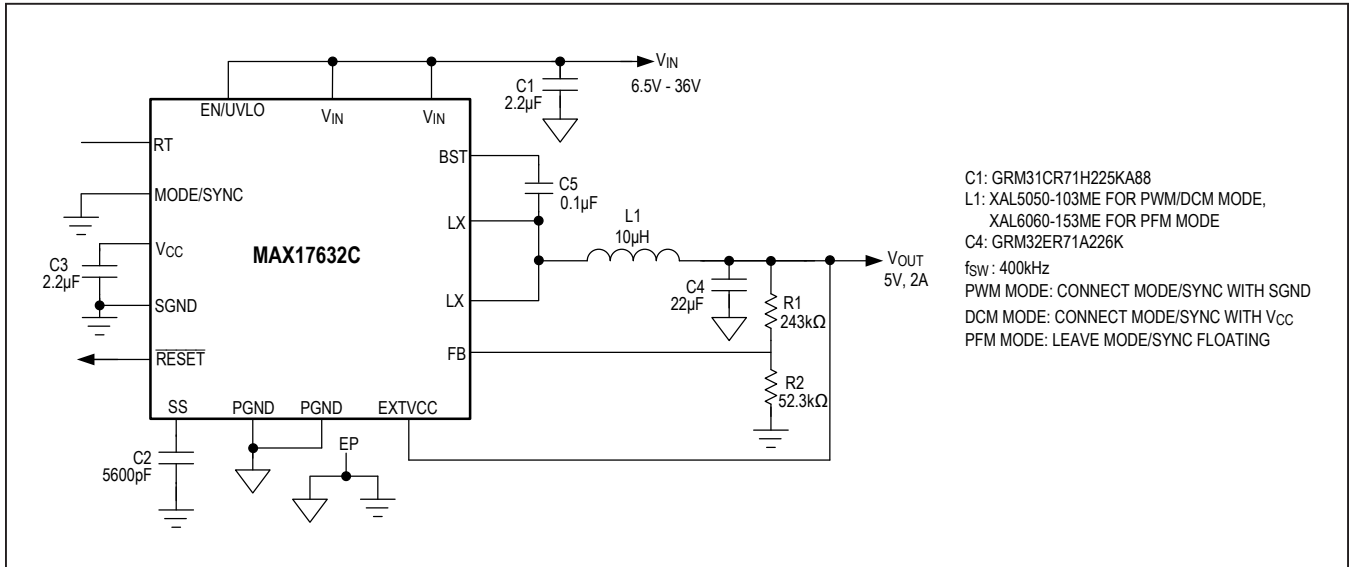

Figure 6. Adjustable 5V Output with 400kHz Switching Frequency

Typical Application Circuit — Adjustable 3.3V Output with High Frequency (1MHz) Design

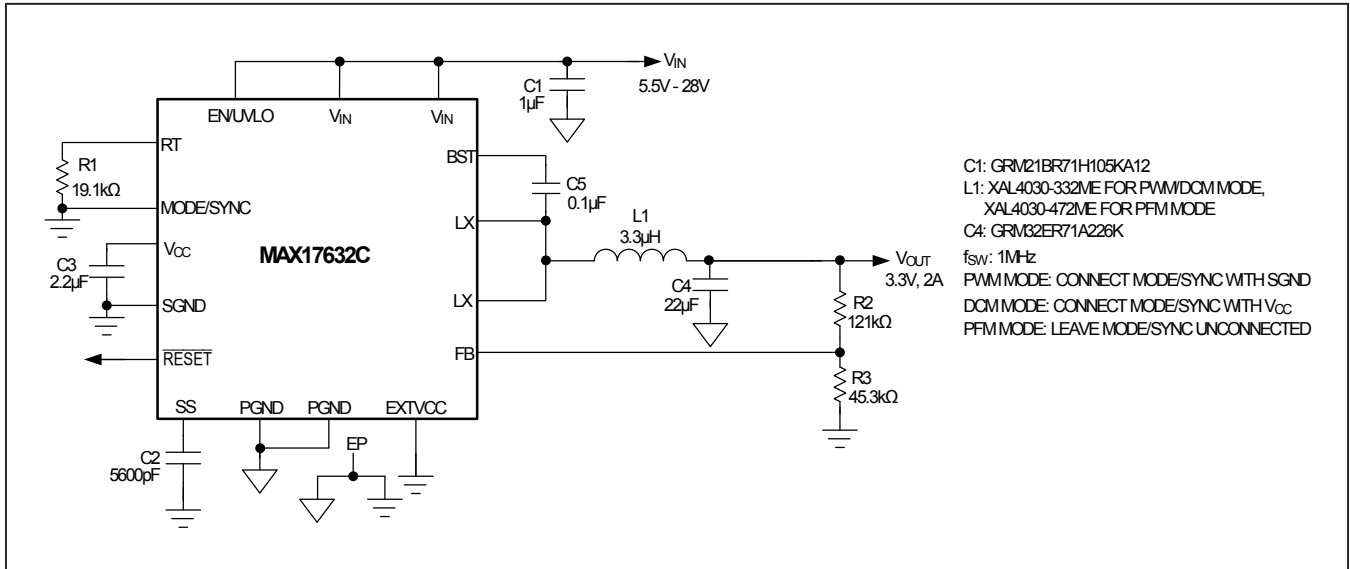

Figure 7. Adjustable 3.3V Output with 1MHz Switching Frequency

Ordering Information

PART NUMBER	OUTPUT VOLTAGE (V)	PIN-PACKAGE
MAX17632AATE+	3.3	16 TQFN 3mm x 3mm
MAX17632BATE+	5	16 TQFN 3mm x 3mm
MAX17632CATE+	Adjustable	16 TQFN 3mm x 3mm

+Denotes a lead(Pb)-free/RoHS compliant package.

MAX17632

4.5V to 36V, 2A, High-Efficiency,
Synchronous Step-Down DC-DC Converter

Revision History

REVISION NUMBER	REVISION DATE	DESCRIPTION	PAGES CHANGED
0	9/17	Initial release	—

For pricing, delivery, and ordering information, please contact Maxim Direct at 1-888-629-4642, or visit Maxim Integrated's website at www.maximintegrated.com.

Maxim Integrated cannot assume responsibility for use of any circuitry other than circuitry entirely embodied in a Maxim Integrated product. No circuit patent licenses are implied. Maxim Integrated reserves the right to change the circuitry and specifications without notice at any time. The parametric values (min and max limits) shown in the Electrical Characteristics table are guaranteed. Other parametric values quoted in this data sheet are provided for guidance.